

P1A Series

- Conforms to ISO 6432 and CETOP RP52P standards
- 5 bore sizes, 10mm to 25mm
- Stainless steel body with black anodized aluminum end caps
- Stainless steel piston rod
- Magnetic piston and bumpers standard

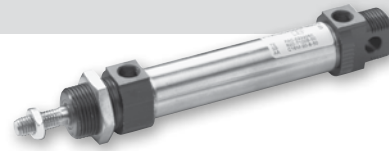

Operating information

Operating pressure:	10 bar (145 PSIG)
Temperature range:	
Working	-20°C to 80°C (-4°F to 176°F)
High temperature version	
20mm, 25mm	-10°C to 150°C (14°F to 302°F)
10mm, 12mm, 16mm	-10°C to 120°C (14°F to 248°F)
Low temperature version	-40°C to 60°C (-40°F to 140°F)
Filtration requirements:	40 micron, dry filtered air



Ordering information

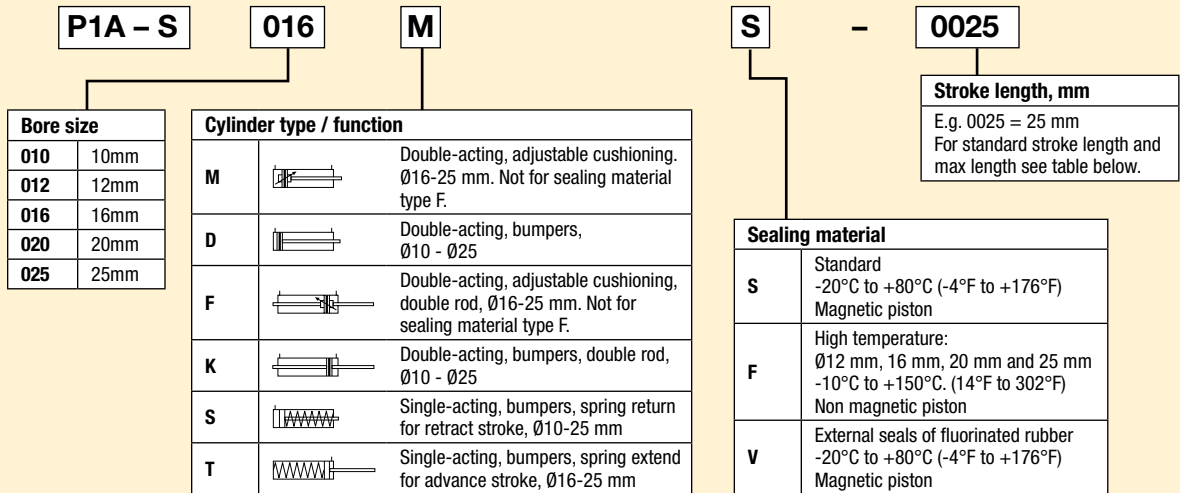

Stroke Lengths		Stroke Length (* = standard, ° = non-standard, blank = N/A)																
Cylinder model	Bore size	10	15	20	25*	30	40	50*	80*	100*	125*	160*	200*	250*	320*	400*	500*	
		Double acting with fixed end-cushioning:																
P1A-S 010 D	10	•	•	•	•	•	•	•	•	•	•	•	•	•	•	•	•	
P1A-S 012 D	12	•	•	•	•	•	•	•	•	•	•	•	•	•	•	•	•	
P1A-S 016 D	16	•	•	•	•	•	•	•	•	•	•	•	•	•	•	•	•	
P1A-S 020 D	20	•	•	•	•	•	•	•	•	•	•	•	•	•	•	•	•	
P1A-S 025 D	25	•	•	•	•	•	•	•	•	•	•	•	•	•	•	•	•	
Double acting with adjustable end-cushioning:																		
P1A-S 016 M	16			•	•	•	•	•	•	•	•	•	•	•	•	•	•	
P1A-S 020 M	20			•	•	•	•	•	•	•	•	•	•	•	•	•	•	
P1A-S 025 M	25			•	•	•	•	•	•	•	•	•	•	•	•	•	•	
Single acting:																		
P1A-S 010 SS	10	•	•	•	•	•	•	•	•									
P1A-S 012 SS	12	•	•	•	•	•	•	•	•									
P1A-S 016 SS(TS)	16	•	•	•	•	•	•	•	•**									
P1A-S 020 SS(TS)	20	•	•	•	•	•	•	•	•									
P1A-S 025 SS(TS)	25	•	•	•	•	•	•	•	•									

* Standard stroke lengths in mm according to ISO 4393
 ** Not for the TS version

Sensors

For sensors see page B339.



Double acting cylinders

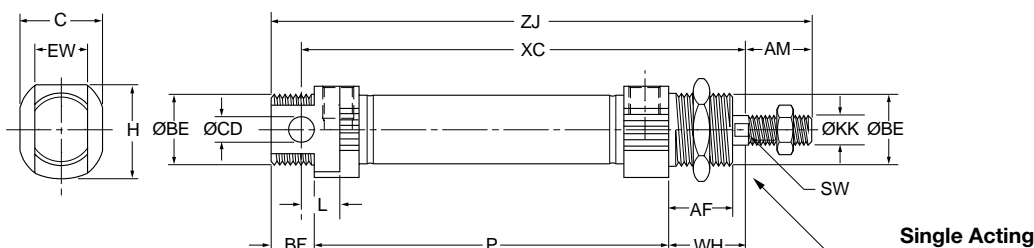

Double piston rod

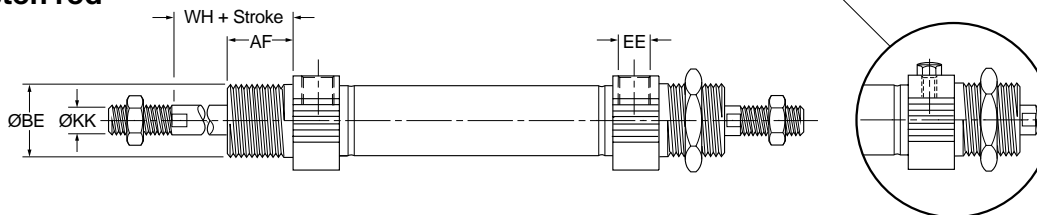

Bore size mm	AM ^{0/-2} mm	BE	AF mm	BF mm	C mm	CD ^{h9} mm	EE	EW mm	H mm	KK	L mm	SW mm	WH \pm 1.2 mm
10	12	M12x1.25	12	10	14.0	4	M5	8	16.7	M4	6	–	16
12	16	M16x1.5	18	13	18.0	6	M5	12	19.1	M6	9	5	22
16 ¹⁾	16	M16x1.5	18	13	18.0	6	M5	12	19.1	M6	9	5	22
16 ²⁾	16	M16x1.5	18	13	25.0	6	M5	12	24.0	M6	9	5	22
20	20	M22x1.5	20	14	24.0	8	G1/8	16	27.0	M8	12	7	24
25	22	M22x1.5	22	14	27.5	8	G1/8	16	29.0	M10x1.25	12	9	28

1) P1A-S016DS/SS/TS 2) P1A-S016MS

Double acting cylinders

Bore size mm	XC mm	ZJ mm	P mm
10	64 + stroke	84 + stroke	46 + stroke
12	75 + stroke	99 + stroke	48 + stroke
16	82 + stroke	104 + stroke	53 + stroke
20	95 + stroke	125 + stroke	67 + stroke
25	104 + stroke	132 + stroke	68 + stroke

Single-acting, spring return, type SS

Bore size mm	XC (mm) at various strokes						ZJ (mm) at various strokes						P (mm) at various strokes					
	10	15	25	40	50	80	10	15	25	40	50	80	10	15	25	40	50	80
10	74	79	89	126	136	174	94	99	109	146	156	194	56	61	71	108	118	156
12	85	90	100	132	142	185	109	114	124	156	166	209	58	63	73	105	115	158
16	92	97	107	122	132	184	114	119	129	144	154	206	63	68	78	93	103	155
20	105	110	120	135	145	191	135	140	150	165	175	221	77	82	92	107	117	163
25	114	119	129	144	154	201	142	147	157	172	182	229	78	83	93	108	118	165

Single-acting, spring-extended, type TS

Bore size mm	ZC ³⁾ (mm) at various strokes					ZJ ³⁾ (mm) at various strokes					P (mm) at various strokes							
	10	15	25	40	80	10	15	25	40	80	10	15	25	40	80			
16	107	112	122	137	147	–	134	139	149	164	174	–	78	83	93	108	118	–
20	120	125	135	150	160	195	156	161	171	186	196	231	92	97	107	122	132	167
25	129	134	144	159	169	205	165	170	180	195	205	241	93	98	108	123	133	169

3) With piston rod retracted, as shown in the dimension drawing
 Length tolerances \pm 1 mm Stroke length tolerance +1.5/0 mm

B
 Round Body Cylinders
 Actuator Products
 SR/SM/SRD/SRDM
 Series
 SRX
 Series
 P1L
 Series
 P1A
 Series
 P
 Series

Flange - MF8

Cylinder Ø mm	A	B	C	D	E	F	Weight lbs	Part number
10	4.5	30	40	22	3	13	0.025	P1A-4CMB
12-16	5.5	40	52	30	4	18	0.055	P1A-4DMB
20	6.6	50	66	40	5	19	0.100	P1A-4HMB
25	6.6	50	66	40	5	23	0.100	

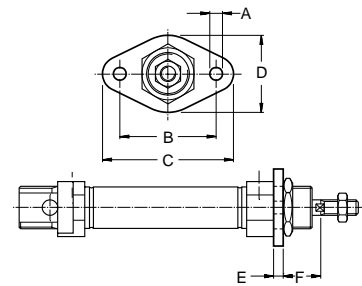
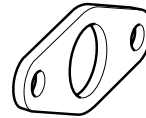

Foot - MS3

Cylinder Ø mm	A	B	C	D	E	F	G	H	I	Weight lbs	Part number
10	4.5	16	25	35	3	24	26.0	16	11	0.045	P1A-4CMF
12-16	5.5	20	32	42	4	32	32.5	20	14	0.08	P1A-4DMF
20	6.5	25	40	54	5	36	45.0	25	17	0.18	P1A-4HMF
25	6.5	25	40	54	5	40	45.0	25	17	0.18	

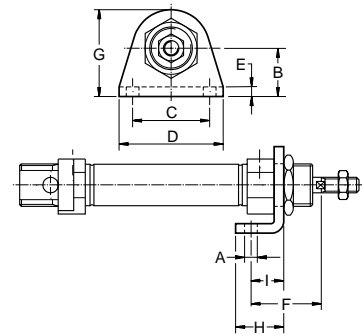
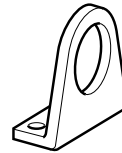

Cover Trunnion

Cylinder Ø mm	A	B h14	C	D	E e9	F	G	H	Weight lbs	Part number
10	12.5	26	38	20	8	4	6	10	0.03	P1A-4CMJ
12-16	16.5	38	58	25	10	6	8	14	0.07	P1A-4DMJ
20	22.5	46	66	30	10	6	8	16	0.08	P1A-4HMJ
25	22.5	46	66	30	10	6	8	20	0.08	

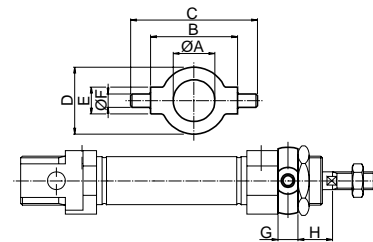
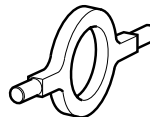

Mounting Nut

Cylinder Ø mm	A	B	C	Weight lbs	Part number
10	19	6	M12x1.25	0.02	9127385101
12-16	24	8	M16x1.50	0.04	9127385102
20-25	32	11	M22x1.50	0.09	9127385103

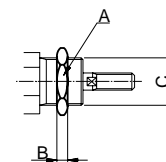

Most popular.



B
 Round Body Cylinders
 Actuator Products
 SR/SM/SRD/SRDM
 Series
 SRX
 Series
 P1L
 Series
 P1A
 Series
 P
 Series

Clevis Bracket

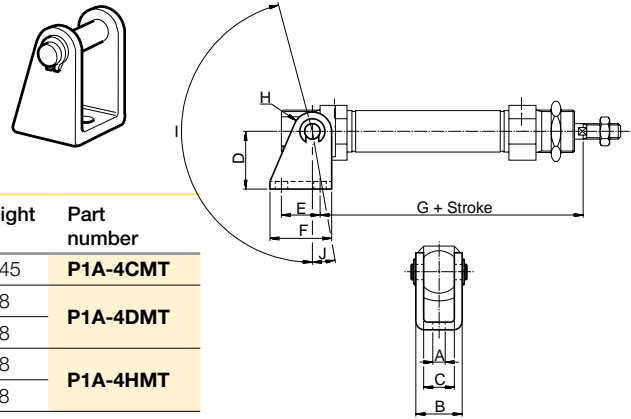

Cylinder Ø mm	A mm	B mm	C mm	D mm	E mm	F mm	G mm	H mm	I °	J °	Weight lbs	Part number
10	4.5	13	8	24	12.5	20	65.3	5	160	17	0.045	P1A-4CMT
12	5.5	18	12	27	15.0	25	73.0	7	170	15	0.08	P1A-4DMT
16	5.5	18	12	27	15.0	25	80.0	7	170	15	0.08	P1A-4DMT
20	6.5	24	16	30	20.0	32	91.0	10	165	10	0.18	P1A-4HMT
25	6.5	24	16	30	20.0	32	100.0	10	165	10	0.18	P1A-4HMT

Rod clevis

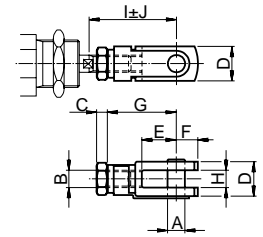
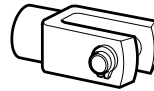

Cylinder Ø mm	A mm	B	C mm	D mm	E mm	F mm	G mm	H mm	I mm	J mm	Weight lbs	Part number
10	4	M4	2.2	8	8	5	16	4	22.0	2.0	0.015	P1A-4CRC
12-16	6	M6	3.2	12	12	7	24	6	31.0	3.0	0.05	P1A-4DRC
20	8	M8	4.0	16	16	10	32	8	40.5	3.5	0.10	P1A-4HRC
25	10	M10 x 1.25	5.0	20	20	12	40	10	49.0	3.0	0.21	P1A-4JRC

Swivel Rod Eye

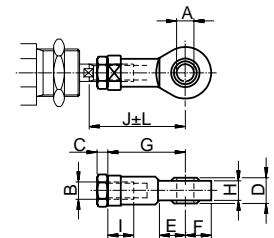
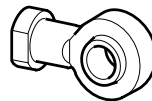

Cylinder Ø mm	A mm	B	C mm	D mm	E mm	F mm	G mm	H mm	I mm	J mm	K mm	L mm	Weight lbs	Part number
10	5	M4	2.2	8	10	9	27	6.0	8	33.0	9	2.0	0.04	P1A-4CRS
12-16	6	M6	3.2	9	10	10	30	6.8	9	38.5	11	1.5	0.06	P1A-4DRS
20	8	M8	4.0	12	12	12	36	9.0	12	46.0	14	2.0	0.10	P1A-4HRS
25	10	M10 x 1.25	5.0	14	14	14	43	10.5	15	52.5	17	2.5	0.19	P1A-4JRS

Rod Nut

Cylinder Ø mm	D mm	F mm	E mm	Weight lbs	Part number
10	M4	7	2.2	0.002	0261110600
12-16	M6	10	3.2	0.004	0261210800
20	M8	13	4.0	0.010	0261211000
25	M10x1.25	17	5.0	0.015	9128985601

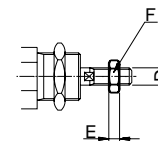

Most popular.

B

Round Body Cylinders
 Actuator Products

SR/SM/SRD/SRDM
 Series

SRX
 Series

P1L
 Series

P1A
 Series

P
 Series