

MOBILE VALVES ACCESSORIES

Sealing Caps - Connector Kits - Hand Levers

**WARNING — USER RESPONSIBILITY****FAILURE OR IMPROPER SELECTION OR IMPROPER USE OF THE PRODUCTS DESCRIBED HEREIN OR RELATED ITEMS CAN CAUSE DEATH, PERSONAL INJURY AND PROPERTY DAMAGE.**

- This document and other information from Parker-Hannifin Corporation, its subsidiaries and authorized distributors provide product or system options for further investigation by users having technical expertise.
- The user, through its own analysis and testing, is solely responsible for making the final selection of the system and components and assuring that all performance, endurance, maintenance, safety and warning requirements of the application are met. The user must analyze all aspects of the application, follow applicable industry standards, and follow the information concerning the product in the current product catalog and in any other materials provided from Parker or its subsidiaries or authorized distributors.
- To the extent that Parker or its subsidiaries or authorized distributors provide component or system options based upon data or specifications provided by the user, the user is responsible for determining that such data and specifications are suitable and sufficient for all applications and reasonably foreseeable uses of the components or systems.

Offer of Sale

Please contact your Parker representation for a detailed "Offer of Sale".

Table of Contents

Sealing caps.....	4
Connector kits	4
Hand levers	5



If you have questions about the products contained in this catalog, or their applications, please contact:
Parker Hannifin EMEA Sàrl European Headquarters
parker.com/msgc

ORDERING INFORMATION

Sealing caps

398000K851

Sealing cap main relief valve PB on IS or IU inlet section, P70, 500 pcs.

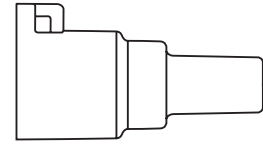

398000D853

Sealing cap pump unloading BEN, P70, 500 pcs.

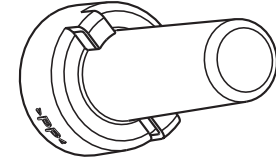

393000K852

Sealing cap, red, 1 pc. Suitable for:

K170LS, Feed reducer MR

VA-Series, Feed Reducer

K220LS, Feed reducer MR, Relief valve PLS

L90LS, Feed reducer MR, Main relief valve LS1 and CFC

Main relief valve PLS

P70 Main relief valve PB on I inlet section

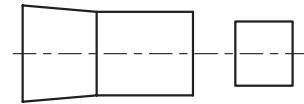

Connector kits

(Kits for connectors of Deutsch type is not available from HVSE.)

9125955110

Connector kit ACE. Suit all valves with spool actuator ACE, 10 pcs.

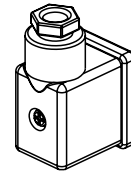

9125955125

Connector kit ACE. Suit all valves with spool actuator ACE, 25 pcs.

393000K825

Connector kit AMP. For solenoids with AMP connector (AMP Junior timer, mates with type C), 10 pcs

393000K826

Connector kit AMP. For solenoids with AMP connector (AMP Junior timer, mates with type C), 50 pcs

393000K827

Connector kit AMP. For solenoids with AMP connector (AMP Junior timer, mates with type C), 100 pcs



393000K632

Cable with connector. For solenoids with AMP connector (AMP Junior timer, mates with type C)

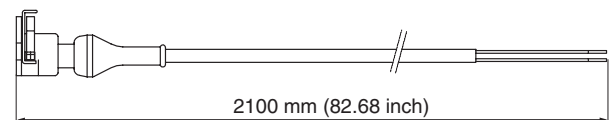

6763001

Manual override tool for PS25M0.

6763002

Manual override tool for PS25M0, 10 pcs.

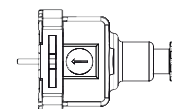

6760627 (replaces 3763932)

POL. adapter G (BSPP threads). Suitable for L90LS.

6760628 (replaces 3764197)

POL. adapter U (UNF threads). Suitable for L90LS.

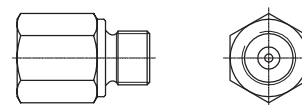

Hand levers

All lever pins in anodized steel. Knobs in black plastic. Oval knobs have a plastic window for placing a symbol.

Where G1 or G2 is stated means valves in Generation 1 or Generation 2.

9122178008

Hand lever kit M7. Suitable for HV07 and L90LS.

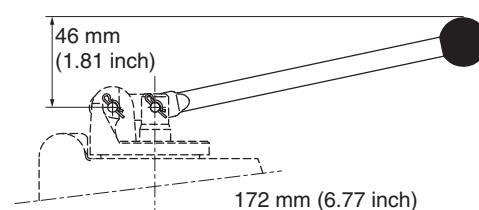

9122178011

Hand lever kit M71. Suitable for HV07 and L90LS.

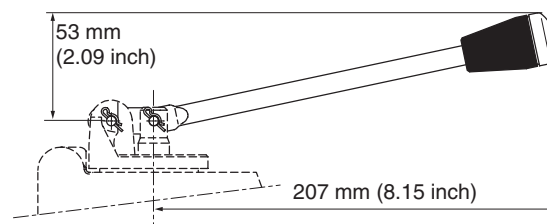

9122178014

Hand lever kit, joystick M710. Suitable for HV07 and L90LS.

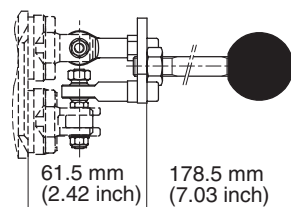

9122178015

Hand lever kit M761. Suitable for HV07 and L90LS.

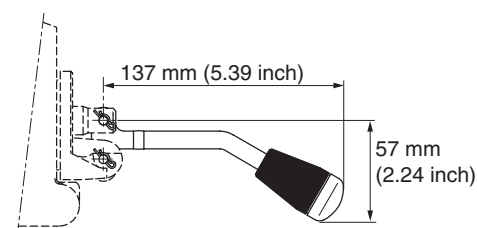

9126180901

Hand lever kit M9. Suitable for HV09, F130 G1 and H170CF.

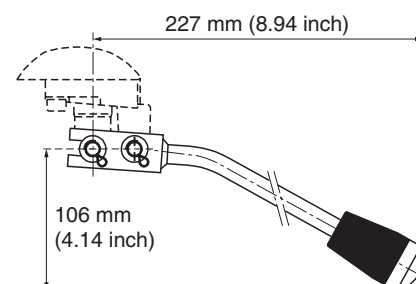

9126205201

Hand lever kit M91. Suitable for HV09, F130 G1 and H170CF.

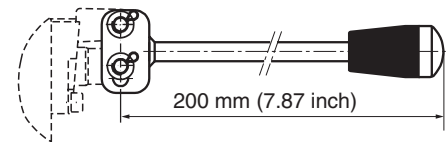
**9126259201**

Hand lever kit M92. Suitable for HV09, F130 G1 and H170CF.

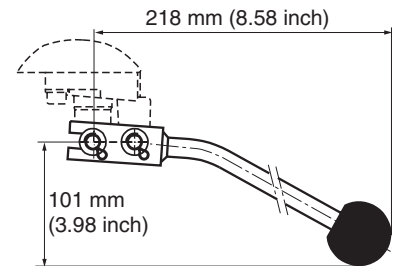
**9126386055**

Hand lever kit M94. Suitable for HV09, F130 G1 and H170CF.

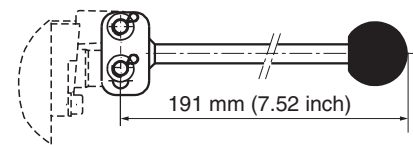
**6763413**

Hand lever kit, joystick M97. Suitable for F130 G2.

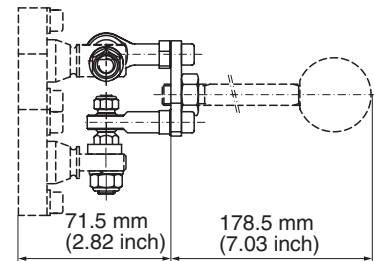
**6763419**

Lever kit M97. Suitable for F130 G2.

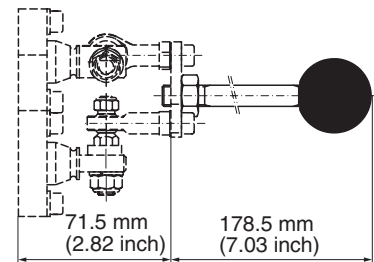
**8234939001**

Hand lever kit ML1. Suitable for Series VA, L90LS P70 and F130 G2 with ECH.

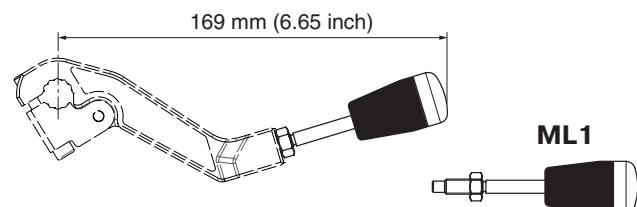

6763758

Hand lever kit MK1. Suitable for K220LS with ECH2, PCH.

676375825

Hand lever kit MK1. Suitable for K220LS with ECH2, PCH. 25 pcs.

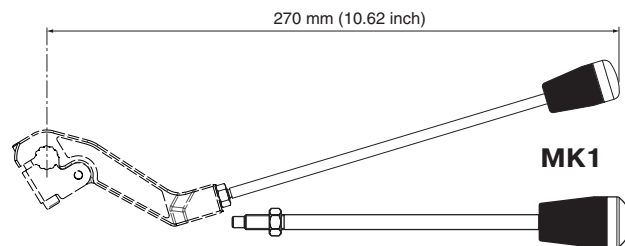
**6761043**

Lever kit without lever pin and knob. Suitable for for Series VA, P70, F130 G2 with ECH, L90LS with ECH3, ECHL3, PCH2, CH2, CHB32, K220LS with ECH2 and PCH. Can be combined with ML1.

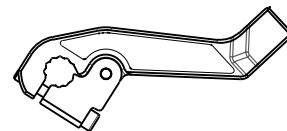
**8234939021**

Hand lever kit MP1. Suitable for P70 and F130 G2. Complete lever in plastic.

823493902125

Hand lever kit MP1. Suitable for P70 and F130 G2. Complete lever in plastic. 25 pcs.

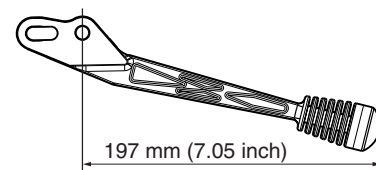
**8234939023**

Hand lever kit MP3. Suitable for P70 and F130 G2.

823493902325

Hand lever kit MP3. Suitable for P70 and F130 G2. 25 pcs.

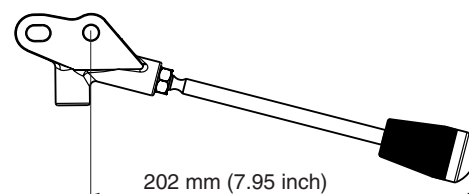
**8234939026**

Hand lever kit MP6. Suitable for P70 and F130 G2.

823493902625

Hand lever kit MP6. Suitable for P70 and F130 G2. 25 pcs.

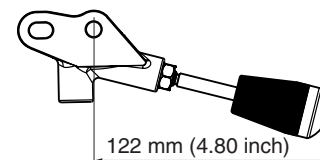
**8234939027**

Hand lever kit MP7. Suitable for P70.

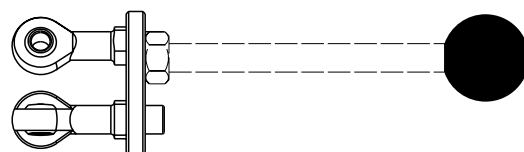
**8234939028**

Hand lever kit MP8. Suitable only in combination with MP7 for P70.

823493902825

Hand lever kit MP8. Suitable only in combination with MP7 for P70. 25 pcs.

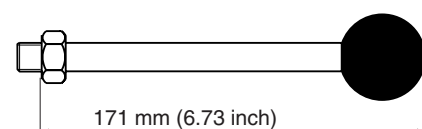

8234939031

Hand lever kit MP11. Suitable for P70 and F130 G2.

**823493903125**

Hand lever kit MP11. Suitable for P70 and F130 G2. 25 pcs.

8234939032

Hand lever kit MP12. Suitable for P70 and F130 G2.

823493903225

Hand lever kit MP12. Suitable for P70 and F130 G2. 25 pcs.

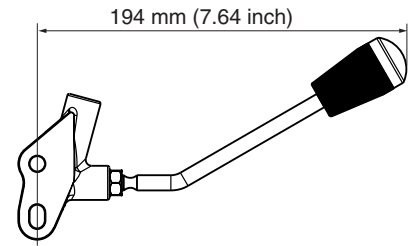
**6760409**

Lever kit, part of MP11

Suitable for P70 and F130 G2.

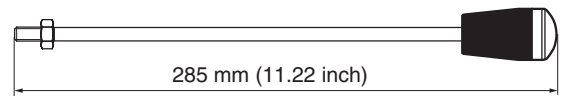
**6760465**

Lever kit without lever pin and knob. Part of MP3, MP6, MP11 and MP12. Suitable for P70 and F130 G2.

**6761044**

Hand lever kit MP13. Suitable for Series VA, P70, G2, F130 G2 with ECH, L90LS with ECH3, ECHL3, PCH2, CH2, CHB32.

676104425

Hand lever kit MP13. Suitable for P70 G2, F130 G2 with ECH, L90LS with ECH3, ECHL3, PCH2, CH2, CHB32. 25 pcs.

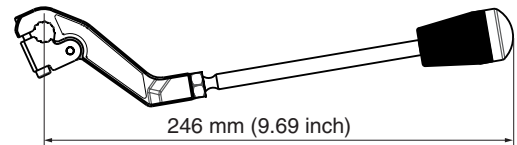
**6760951**

Handle knob with window kit. Black.

Suitable for all our hand levers with oval knob.

**6760955**

Handle knob with window kit. Red.

Suitable for all our hand levers with oval knob.

**6760546**

Handle Window kit. 6 pcs.

Suitable for all our hand levers with oval knob.



6761046

Hand lever kit MP14, black knob. Suitable for Series VA, P70, G2, F130 G2 with ECH, L90LS with ECH3, ECHL3, PCH2, CH2, CHB32.

676104625

Hand lever kit MP14, black knob. Suitable for Series VA, P70, G2, F130 G2 with ECH, L90LS with ECH3, ECHL3, PCH2, CH2, CHB32. 25 pcs.

6761048

Hand lever kit MP15, red knob. Suitable for Series VA, P70, G2, F130 G2 with ECH, L90LS with ECH3, ECHL3, PCH2, CH2, CHB32.

676104825

Hand lever kit MP15, red knob. Suitable for Series VA, P70, G2, F130 G2 with ECH, L90LS with ECH3, ECHL3, PCH2, CH2, CHB32. 25 pcs.

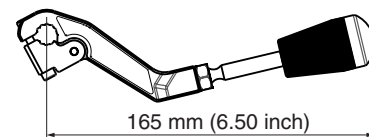
**6760314**

Hand lever kit MP16.

Suitable only in combination with MP7 for P70 G2.

Thumb switch symbol

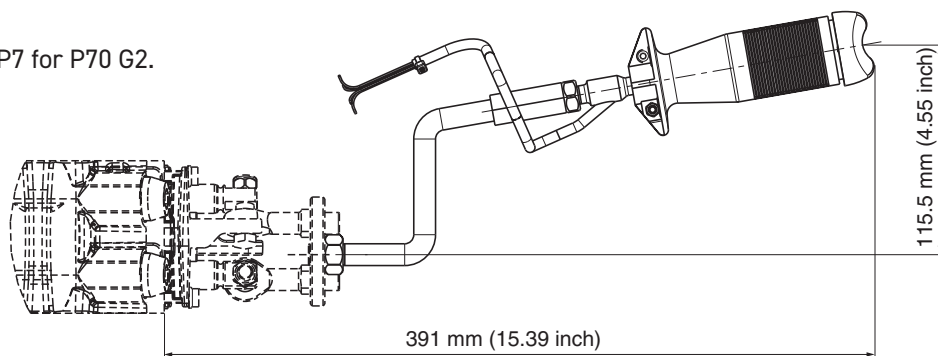
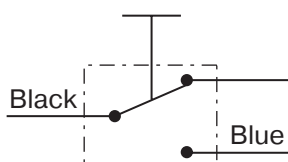
**6760401**

PCL402 handle typ E1, micro switch with IP67 class

Thumb switch symbol

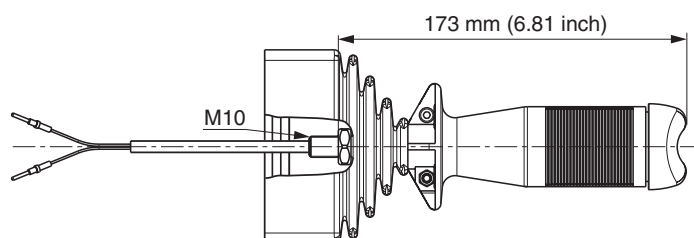
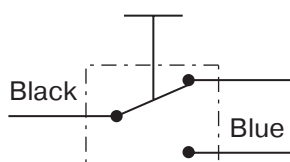
**6760382**

Hand lever kit MP17.

Same as MP12, but reinforced lever attachment. Suitable for P70 and F130 G2.

6760623

25 pcs.

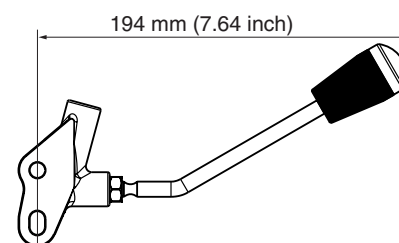

6763122

Lever kit without lever pin and knob.
Part of MP17 reinforced lever attachment.
Suitable for P70 G2 and F130 G2.

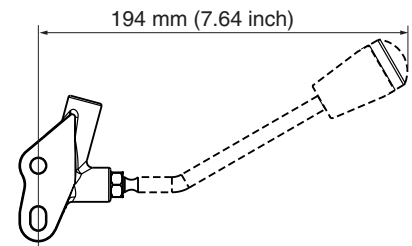
**6760608**

Hand lever kits MP18.
Same as MP3, but all steel parts in stainless steel.
Suitable for P70 and F130 G2.

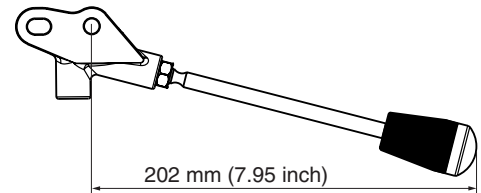
**9120092540**

Hand lever kit suitable for H170CF with spool actuator PCH
and K170LS with spool actuator PCH, ECH and EBH.

Please note: This lever is included in the valve.
This kit is only a Spare Part Kit, not an accessory.

