

Parker OIL-X

High Efficiency, Low Energy
Compressed Air Filters



ENGINEERING YOUR SUCCESS.

Compressed air contamination is a real problem

In today's modern production facilities, the use of compressed air is often pivotal to manufacturing processes. Irrespective of whether the compressed air comes into direct contact with the product or is used to automate a process, provide motive power, or even to generate other gases on-site, a clean, dry, reliable compressed air supply is essential to maintain safe, efficient and cost-effective production.

Most problems experienced by compressed air users derive from contamination already in the compressed air system. Typically, there are 10 different contaminants from four different sources that need to be reduced to acceptable levels.

10 CONTAMINANTS FOUR SOURCES

These must be removed or reduced to acceptable levels in order to protect equipment, applications and products.

2. COMPRESSOR

CONTAMINANTS

- Liquid Oil
- Oil Aerosols
- Oil Vapor (from compressor oil)
- Condensed Water
- Water Aerosols

4. DISTRIBUTION PIPING

CONTAMINANTS

- Rust
- Pipescale

3. AIR RECEIVER

CONTAMINANTS

- Rust
- Pipescale

1. AIR INTAKE

CONTAMINANTS

- Water Vapor
- Microorganisms
- Atmospheric Dirt
- Oil Vapor

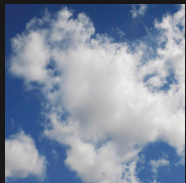
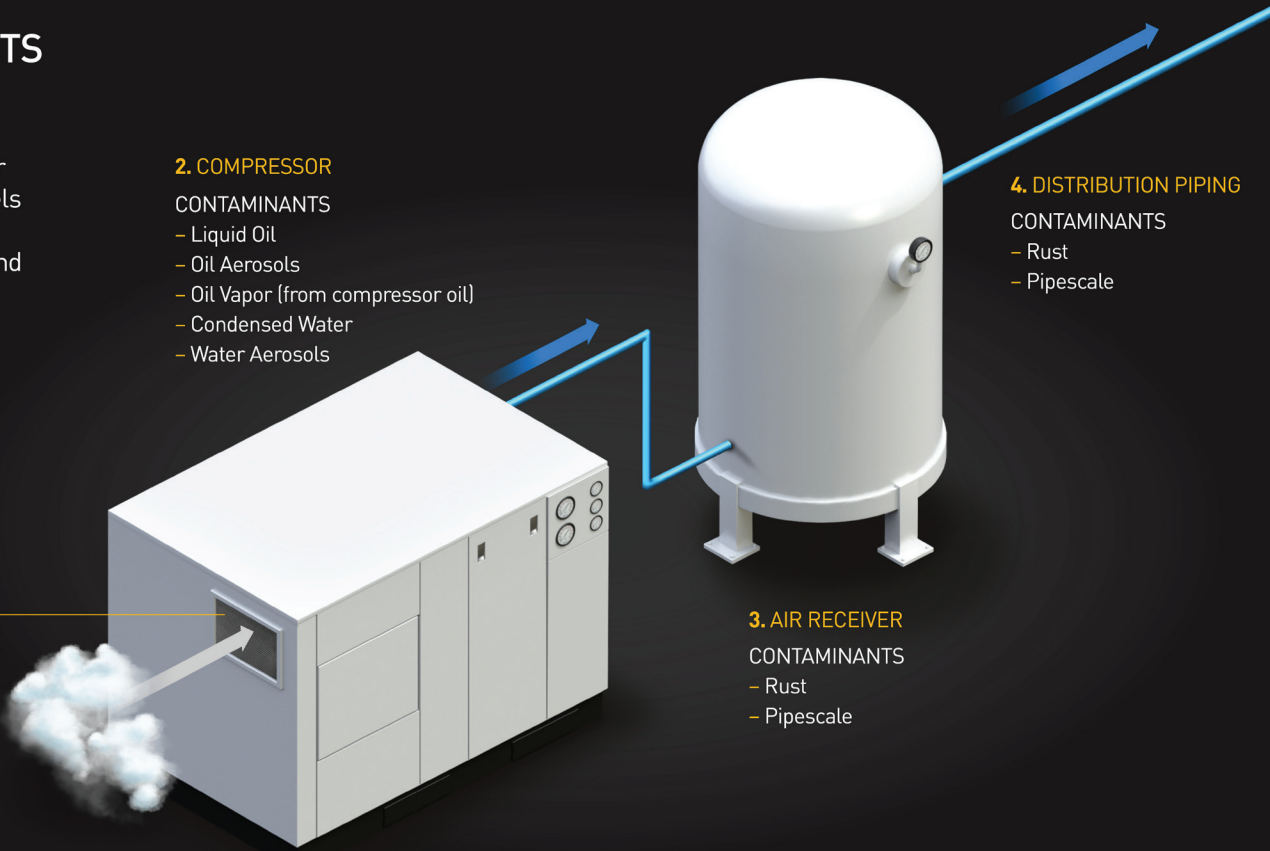

Water Vapor

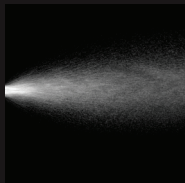

Water Aerosol
Oil Aerosol



Liquid Water



Micro-organisms



Oil Vapor



Liquid Oil



Particulates

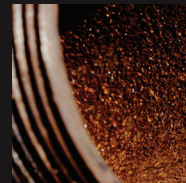

Rust & Pipescale

Failure to treat contamination will cause many problems with the compressed air system, for example:

- Corrosion within compressed air storage vessels and the air distribution system
- Blocked or damaged valves, cylinders, air motors and air tools
- Damaged production equipment
- Premature and unplanned desiccant changes for adsorption dryers
- Product contamination

Compressed air contamination will ultimately lead to:

- Inefficient production processes
- Spoiled, damaged or reworked products
- Reduced production efficiency
- Increased manufacturing costs

In addition to problems associated with the compressed air system itself, allowing contaminants such as particulate, oil and micro-organisms to exhaust from valves, cylinders and air tools, can lead to an unhealthy and unsafe working environment.

Compressed Air Treatment

Compressed air purification equipment is essential. It must deliver uncompromising performance and reliability while combining the right balance of air quality with the lowest cost of operation.

OIL-X - The original name in Compressed Air Purification

The origins of modern compressed air filtration can be traced back to domnick hunter in 1963, it was the first company to use microfiber filter media for purification applications, changing the compressed air industry forever.

The OIL-X filter range introduced in 1972 was the first filter range to fully utilize this ground breaking technology and has always been synonymous with high quality compressed air. Now in the 21st century, the OIL-X name remains, but the technology has evolved beyond recognition.

Parker OIL-X

Since the introduction of the first OIL-X range, Parker has continued to develop both the compressed air filter and the standards governing compressed air quality. Constantly innovated, OIL-X has become the leading technology for compressed air filtration, providing the exact balance between air quality, energy efficiency and low lifetime costs.



The OIL-X Filtration Solution

“Of the 10 major contaminants found in compressed air, nine are treated using filtration technology”

Purification Technologies	Contaminants									
	Atmospheric Particles	Rust	Pipescale	Micro-organisms	Liquid Water	Water Aerosol	Water Vapor	Liquid Oil	Oil Aerosol	Oil Vapor
Water Separator					•			•		
Coalescing Filters	•	•	•	•		•			•	
Adsorption Filter										•
Dryer							•			
Dry Particulate Filter	•	•	•	•						
Sterile Filters				•						

Water Separators (OIL-X Grade WS)

Although called water separators, they reduce the content of all liquids at the point of installation. Water separators are usually the first piece of purification equipment installed downstream of an after-cooler or wet air receiver and should be used to protect coalescing filters from liquid contamination. They will only reduce liquids and will have no effect on water or oil in an aerosol or vapor phase.

Coalescing Filters (OIL-X Grades AO & AA)

Coalescing filters are probably the single most important items of purification equipment in a compressed air system. They are designed to not only remove aerosols (droplets) of oil and water using mechanical filtration techniques, but to remove solid particulate to very low levels (as small as 0.01 micron in size).

Installed in pairs, the first compressed air filter is a ‘general purpose filter’ which protects the second ‘high efficiency filter’ from bulk contamination.

Dry Particulate Filters (OIL-X Grades AO & AA)

Dry particulate filters provide identical particulate removal performance to the equivalent grade coalescing filter. Relying on mechanical filtration techniques, high efficiency dry particulate filters can provide particle reduction down to 0.01 micron with a removal efficiency of 99.9999%. When coupled with a Pressure Dewpoint $\leq -40^{\circ}\text{C}$, to inhibit and control the growth of micro-organisms, they can provide significant reduction of microbiological contaminants.

Adsorption (activated carbon) Filters (OIL-X Grades ACS & OVR)

Oil vapor is oil in a gaseous form and will pass through a coalescing filter just as easily as the compressed air. Oil vapor removal filters provide a large bed of activated carbon adsorbent for the effective removal of oil vapor, providing a high level of protection against oil contamination.



Air Quality

ISO8573 is the group of international standards relating to the quality (purity) of compressed air.

The standard consists of nine separate parts, with part 1 relating to quality classifications for compressed air and parts 2 – 9 specifying the methods of testing for a range of contaminants.

ISO 8573 Series - Part 1

ISO8573-1 is the primary document used from the nine parts of the ISO8573 standard. Importantly, ISO8573-1 contains air purity classification tables.

ISO8573-1:2010 CLASS	Solid Particulate			Mass Concentration mg/m ³	Vapor Pressure Dewpoint	Water Liquid g/m ³	Oil Total Oil (aerosol liquid and vapor) mg/m ³
	Maximum number of particulates per m ³						
	0.1 - 0.5 micron	0.5 - 1 micron	1 - 5 micron				
0	As specified by the equipment user or supplier and more stringent than Class 1						
1	≤ 20,000	≤ 400	≤ 10	—	≤ -70°C	—	0.01
2	≤ 400,000	≤ 6,000	≤ 100	—	≤ -40°C	—	0.1
3	—	≤ 90,000	≤ 1,000	—	≤ -20°C	—	1
4	—	—	≤ 10,000	—	≤ +3°C	—	5
5	—	—	≤ 100,000	—	≤ +7°C	—	—
6	—	—	—	≤ 5	≤ +10°C	—	—
7	—	—	—	5 - 10	—	≤ 0.5	—
8	—	—	—	—	—	0.5 - 5	—
9	—	—	—	—	—	5 - 10	—
X	—	—	—	> 10	—	> 10	> 10

The tables can be used in one of three ways.

- Compressed air users can use the air purity classifications to specify the amount of contamination allowed in each cubic meter of compressed air
 - i.e. specify the minimum air purity (quality) they require at each usage point in the compressed air system
- It can be used to classify the purity (Quality) of compressed air at a specific point in the compressed air system (based upon the contaminants found following testing at that sample point)
- Compressed air purification equipment manufacturers can use the air purity classifications to specify the purity (quality) of compressed air delivered downstream of their purification equipment

Parker OIL-X #1 in filtration

- Air quality that exceeds the requirements of ISO8573-1
- Class 0 (<0.003mg/m³) for Total Oil / • Classes 1 - 4 for Total Oil
- Classes 1 - 5 for particulate
- ISO 8573-1 Classifications verified by Lloyds Register



Parker OIL-X - ISO 8573-1:2010 Classifications

ISO 8573-1:2010 CLASS	Solid Particulate		Water Vapor	Oil Total Oil (aerosol liquid and vapor)
	Wet Particulate	Dry Particulate		
0	—	—	—	OIL-X Grade AO + AA + OVR
1	OIL-X Grade AO + AA	OIL-X Grade AO (M) + AA (M)	Dryer sized for -70°C PDP	OIL-X Grade AO + AA + OVR OIL-X Grade AO + AA + ACS
2	OIL-X Grade AO	OIL-X Grade AO (M)	Dryer sized for -40°C PDP	OIL-X Grade AO + AA
3	OIL-X Grade AO	OIL-X Grade AO (M)	Dryer sized for -20°C PDP	OIL-X Grade AO
4	OIL-X Grade AO	OIL-X Grade AO (M)	Dryer sized for +3°C PDP	OIL-X Grade AO
5	OIL-X Grade AO	OIL-X Grade AO (M)	Dryer sized for +7°C PDP	—
6	—	—	Dryer sized for +10°C PDP	—

OIL-X Grades AO & AA above represent coalescing filter variants fitted with an automatic drain
 OIL-X Grades AO (M) & AA (M) above represent dry particulate filter variants fitted with a manual drain

Compressed Air Filters & Elements may look the same, but they don't all perform the same.

From the outside, filters from different manufactures look almost identical, but how do they perform on the inside? Fortunately, there is an International Standard, ISO 12500-1 that was specifically produced to allow manufacturers to show the performance of their coalescing filter products at a set of standard reference conditions, allowing easy comparison.

The ISO 12500-1 test method states that a filter on test is “challenged” with a prescribed amount of oil aerosol and provides two challenge concentrations, 40mg/m³ and 10mg/m³ for manufactures to choose from.

Three filters of the same size are tested in this way and each filter is tested three times. The results used are an average of the nine tests. ISO 12500-1 testing will provide information relating to:

- **Filtration Performance**

In the form of the aerosol “carryover” (or how much aerosol gets through the filter)

- **Energy Consumption**

At the start of the filters life, in the form of Initial Saturated differential pressure (dP)

Parker OIL-X #1 in filtration

- Coalescing Filter Performance tested in accordance with ISO12500-1, ISO 8573-2 & ISO8573-4
- Filtration performance independently verified by Lloyds Register
- Only filter range to offer a one year air quality guarantee



Parker OIL-X - Filtration Performance at all flow conditions

The ISO 12500-1 standard was designed to test a coalescing filter at its worst-case parameters of 100% maximum rated flow, however it does not include a requirement to test a filter at partial flow. As coalescing filter construction varies from manufacturer to manufacturer, performance at partial flow can vary and while a filter may perform well at 100% of rated flow, it may not do so at lower flow rates.

Due to the unique OIL-X filter element construction, for each port size, the OIL-X filter range has some of the highest flow rates available today. However, filters are seldom operated at 100% of rated flow. Many filters are often selected to match pipe size of the installation. Additionally, many compressed air systems are installing variable speed compressors that adjust air flow to better match energy consumption to air demand.

The Parker OIL-X filtration range has been designed to maintain filtration performance with variable inlet flow rates such as those found when variable speed compressors are installed. As can be seen in the graph, OIL-X filtration efficiency remains constant at partial flow conditions from 10% to 100% of the filters rated capacity.

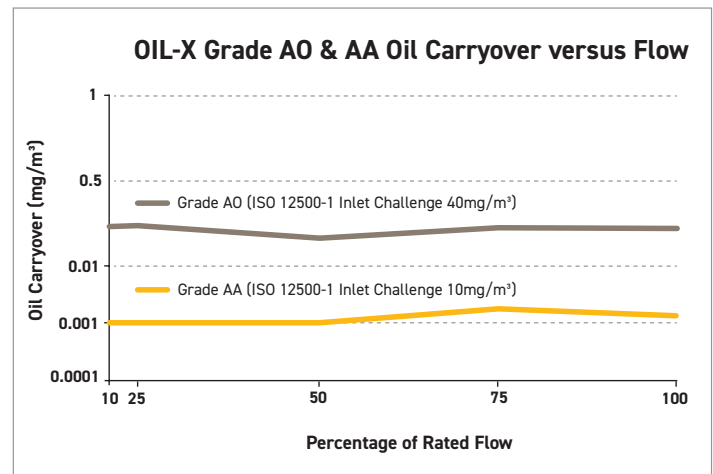

Energy Efficiency

Any restriction to air flow within a filter housing and element will reduce the system pressure. To generate compressed air, large amounts of electrical energy is consumed, therefore any pressure losses within the system can be directly converted into a cost for wasted energy. The higher the pressure loss, the higher the energy cost.

The results of ISO 12500-1 testing not only provide information relating to air quality, it also provides Initial Dry and Initial Saturated differential pressure (dP) data, which can be equated back to energy consumption.

As previously stated, the ISO 12500-1 test is based upon the filter operating at 100% maximum flow and filtration literature often includes this data.

Parker OIL-X #1 in filtration

- First industrial filter range to provide Differential Pressure (dP) data for individual models
- First industrial filter range to provide dP data at variable flow conditions (25% / 50% / 75% 100% of rated flow)
- First industrial filter range to provide dP curves for each filter model

Parker understands that filters are not always operated at 100% of rated flow, therefore Parker OIL-X is the first industrial filter range to show the initial dry and initial saturated differential pressure data for each individual filter (not just the filter range) and at 25%, 50%, 75% & 100% of the filters maximum flow rate).

Model	Initial Saturated Differential Pressure			
	100% Flow	75% Flow	50% Flow	25% Flow
	psi	psi	psi	psi
AOPX010A	.88	.58	.29	.13
AOPX010B	.91	.62	.32	.16
AOPX010C	.84	.51	.29	.16
AOPX015B	.87	.55	.33	.17
AOPX015C	.39	.22	.15	.07

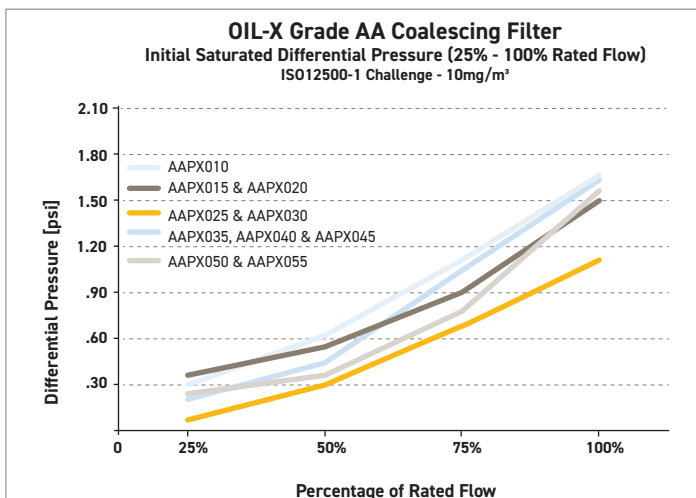
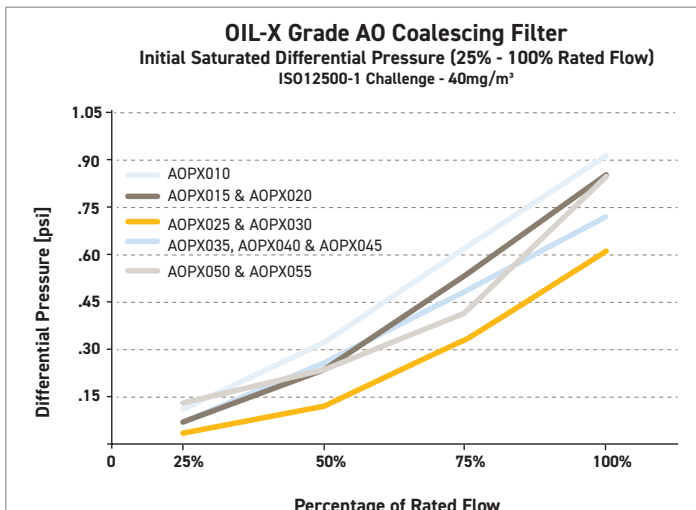

Initial Dry & Initial Wet Differential Pressure What does it mean?

The construction of coalescing and dry particulate filters is identical, however their operation differs slightly as the coalescing filter collects aerosols of oil and water in addition to solid particles. As a coalescing filter starts to collect these aerosols it is known as "wetting out" with liquids.

Initial dry differential pressure for a coalescing filter is the dP of a filter and its element before the element wets out.

The initial saturated differential pressure for a coalescing filter is the dP for the filter housing and its element after it wets out (typically 24 hours).

As Dry Particulate variants do not collect aerosols, only dry dP is used.

The term 'initial' refers to the fact the dP was recorded when the filter element was in a clean or "as new" condition and is representative of the dP at the beginning of the filter elements life.

Initial dP figures do not take into consideration the blockage characteristics of the filter element and should be only be used as a 'best case' figure and never to calculate the annual operational costs of a compressed air filter.

Low Lifetime Costs

Finding the initial dry and initial saturated differential pressure of a filter is just the start when looking at filter energy consumption. These figures are important, but only relate to a clean, out of the box filter and are an indication of a filter's energy consumption at the beginning of its life.

Today, many different brands of compressed air filters are available. Although visually similar, and with performance that on paper may appear identical, when put into operation, a very different story is often told. Compressed

air filters are often bought with a compressor; as part of a package deal and therefore selected based upon purchase cost, with little or no regard for the delivered air quality or total cost of ownership.

A filter with a low purchase price may not always turn out to be the most cost-effective solution.

Calculating the true cost

Compressed air filters from different manufacturers look similar however, they are very different on the inside.

Each manufacturer uses different filter media and a different construction method for their element; therefore, the blockage characteristics of each filter will be different.

Dirt loading Testing provides a true picture of a filter's energy consumption and is used to demonstrate a filter's blockage characteristics.

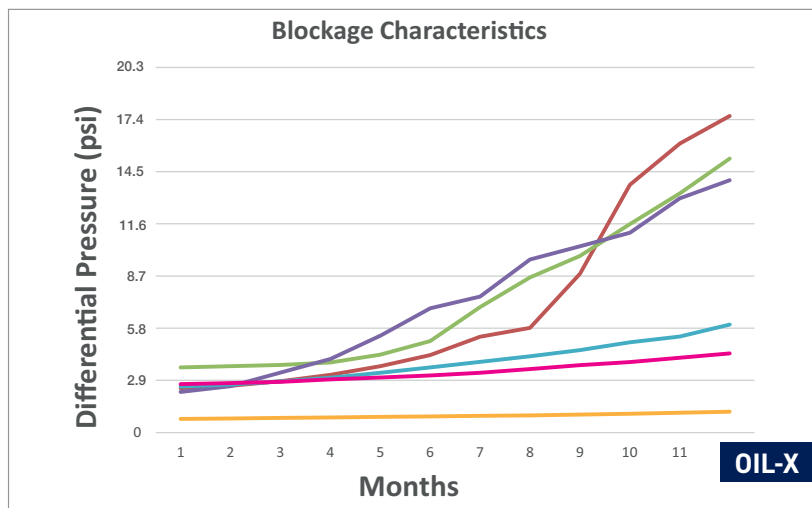

Parker OIL-X - Differential Pressure that Starts Low & Stays Low

In comparative testing of Parker OIL-X filters against commonly available alternative filters, the blockage characteristics and therefore the

true differential pressure of each filter can be demonstrated. This data can then be used to calculate a realistic life time cost for each filter.

Environmentally Friendly



Reduced CO₂ Emissions

Many countries worldwide are looking closely at their manufacturing industries in an effort to reduce the amount of harmful greenhouse gases released into the atmosphere.

The use of electricity has a direct impact on the generation and release of CO₂. By reducing energy consumption, efficient filtration helps to reduce the carbon footprint of a manufacturing facility and protects the environment.

Parker OIL-X #1 in filtration

At Parker we continually develop our filtration ranges to ensure that every compressed air filter we deliver offers the right balance between filtration performance and energy consumption, resulting in a reliable compressed air system with low total cost of ownership.

OIL-X Features providing air quality

The Parker OIL-X range of die-cast compressed air filters has been designed from the outset to meet the air quality requirements of all editions of ISO8573-1, when validated in accordance with the stringent requirements of ISO12500-1.



Correct selection of filtration media

Coalescing and dry particulate filters use a high efficiency borosilicate glass nanofiber material which has a 96% voids volume, providing media with excellent filtration efficiency and a high dirt holding capacity.

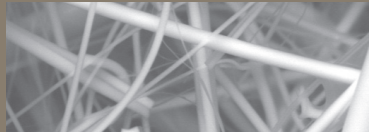

Construction of the filtration media into a filter element

OIL-X filter media is constructed into a filter element using a unique deep bed pleating technique in place of the more conventional wrapped construction.

This provides 450% more filtration surface area when compared to a traditional wrapped filter element and around 200% more surface area compared to a traditional pleated element.

Deep bed pleating also reduces the air flow velocity within the media, which further improves filtration performance.

Additionally, the high efficiency AA grade elements have a unique graded density media construction which provides even greater filtration performance without adding to pressure loss or energy consumption.

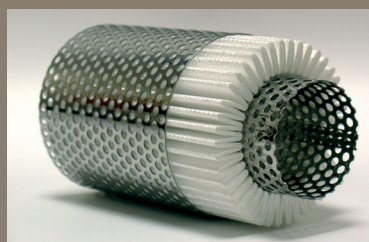

OIL-X coalescing filters utilize four drainage methods to ensure high performance liquid removal, whilst conventional filters use only one.

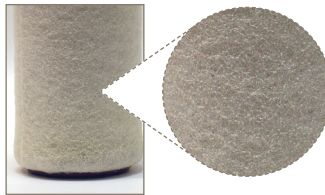

Drainage method 1

High efficiency drainage layer provides increased liquid drainage, improved chemical compatibility and higher operational temperatures when compared to ordinary materials.

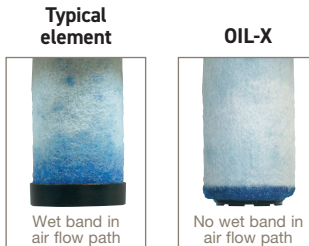

Typical element

OIL-X

Wet band in air flow path

No wet band in air flow path

Drainage method 2

Typical filter elements have a build-up of liquid known as a "wet band" where the drainage layer is glued into the lower endcap. The OIL-X design wraps the drainage layer under the lower endcap to remove coalesced liquid from the air flow path, increasing liquid removal efficiency, and providing more usable filtration surface area.

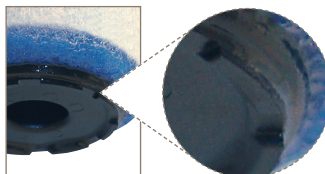

Drainage method 3

Surface tension breakers on the lower filter element endcap provide fast and efficient drainage of coalesced liquid.

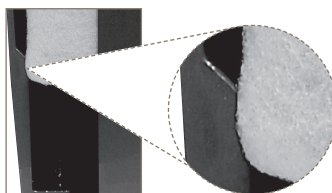

Drainage method 4

Drainage ribs cast into the filter bowl compress the lower part of the filter element, allowing bulk liquid to rapidly drain from the filter element through capillary action.

OIL-X Features providing energy efficiency

Parker OIL-X filters incorporate a number of unique and patented design features to minimize differential pressure and provide a filter and element combination where the differential pressure starts low and stays low to maximize energy savings and provide the lowest lifetime costs without compromising air quality.

OIL-X 1/4" - 3" Filter Range - Optimized flow path from patented Aerospace Flow Management System

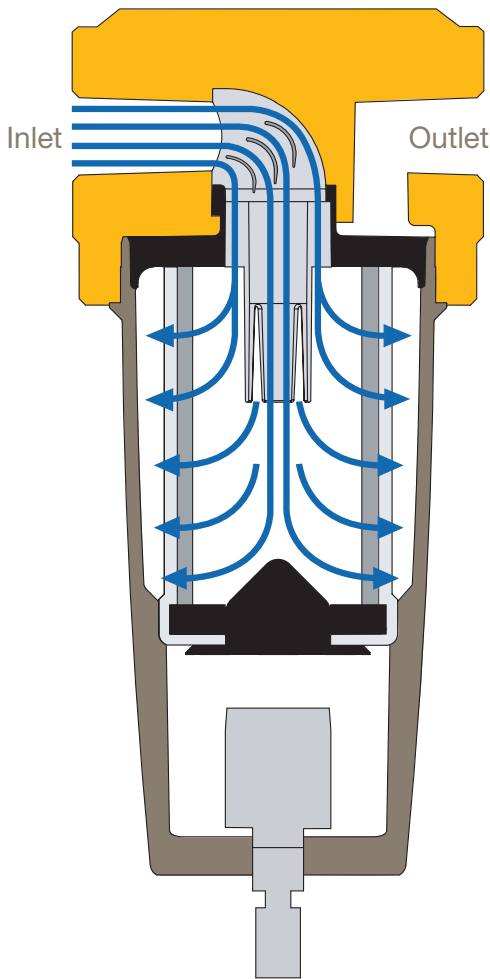

Providing an optimal flow path for the compressed air through the filter housing and element is key to reducing system operating costs

Pressure losses in a compressed air filter is a combination of fixed pressure losses and incremental pressure losses.

Fixed pressure losses are derived from the filter housing and the interface between the filter housing and filter element.

Incremental pressure losses are directly related to the filter element as it blocks up with contamination.

In most filters, high operational costs can be attributed to an inefficient air flow path within the filter housing and element and poorly selected filtration media.

In addition to this, the high differential pressure "change points" recommended by many filter manufacturers increase operational costs even further.



"Bell mouth" housing inlet & full flow inlet conduit

Smooths air flow into the filter, reducing turbulence and pressure loss



Smooth 90° elbow & aerospace turning vanes

Significantly reduces turbulence and pressure loss



Flow distributor

Used to evenly distribute air flow to the upper, middle and lower sections of the filter element



Conical flow diffuser

Distributes airflow at the lower end of the filter element and prevents turbulence which can lead to pressure loss



Deep bed pleating

Deep bed pleating reduces the air flow velocity within the filtration media. This both improves filtration performance of the filter element and also reduces pressure losses.



Specialist media treatment

OIL-X filter media includes a specialist treatment. This actively repels oil and water to ensure that coalesced liquid does not reduce the voids volume. Maintaining a high voids volume reduces the risk of premature blockage, system pressure losses and high energy consumption.

Grade WS Liquid Separator

Separation Performance

Filtration Grade	Filter Type	Particle Reduction (inc water & oil aerosols)	Max Remaining Oil Content at 70°F (21°C)	Liquid Separation Efficiency	Change Element Every	Precede with Filtration Grade
WS	Liquid	Not Applicable	Not Applicable	>93%	Not Applicable	Not Applicable

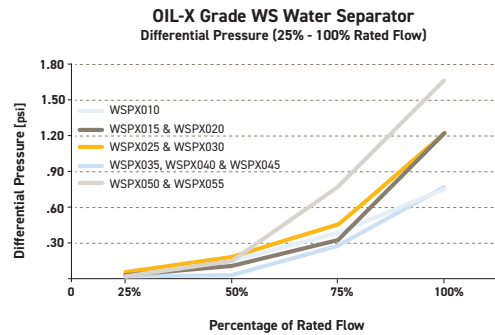
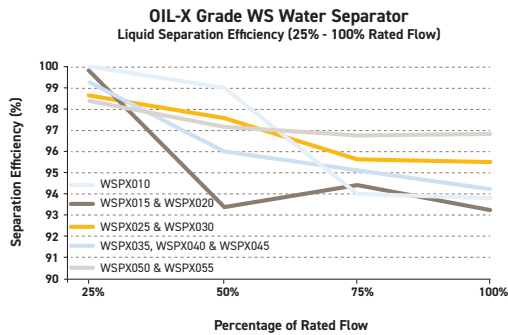

Technical Data

Filtration Grade	Water Separator Models	Min Operating Pressure		Max Operating Pressure		Min Operating Temperature		Max Operating Temperature	
		bar g	psi g	bar g	psi g	°C	°F	°C	°F
WS	PX010A - P055 (Float Drain)	1.5	22	16	232	2	35	65	149

Flow Rates Stated flows are for operation at 100 psi g (7 bar g) with reference to 68°F (20°C), 14.5 psi g (1 bar g), 0% relative water vapor pressure.

Model	Pipe Size	L/S	m³/min	m³/hr	cfm	Initial Saturated Differential Pressure							
						100% Flow		75% Flow		50% Flow		25% Flow	
						mbar	psi	mbar	psi	mbar	psi	mbar	psi
WSPX010A <input type="checkbox"/> <input checked="" type="checkbox"/> FX-US	½"	10	0.6	36	21	53	0.8	29	0.4	14	0.2	4	0.1
WSPX010B <input type="checkbox"/> <input checked="" type="checkbox"/> FX-US	¾"	10	0.6	36	21	51	0.7	27	0.4	12	0.2	2	0.0
WSPX010C <input type="checkbox"/> <input checked="" type="checkbox"/> FX-US	½"	10	0.6	36	21	48	0.7	25	0.4	10	0.1	0	0.0
WSPX015B <input type="checkbox"/> <input checked="" type="checkbox"/> FX-US	¾"	40	2.4	144	85	64	0.9	25	0.4	12	0.2	6	0.1
WSPX015C <input type="checkbox"/> <input checked="" type="checkbox"/> FX-US	½"	40	2.4	144	85	55	0.8	22	0.3	10	0.1	4	0.1
WSPX020D <input type="checkbox"/> <input checked="" type="checkbox"/> FX-US	¾"	40	2.4	144	85	42	0.6	22	0.3	7	0.1	2	0.0
WSPX025D <input type="checkbox"/> <input checked="" type="checkbox"/> FX-US	¾"	110	6.6	396	233	98	1.4	55	0.8	23	0.3	4	0.1
WSPX025E <input type="checkbox"/> <input checked="" type="checkbox"/> FX-US	1"	110	6.6	396	233	95	1.4	52	0.8	20	0.3	1	0.0
WSPX030G <input type="checkbox"/> <input checked="" type="checkbox"/> FX-US	1 ½"	110	6.6	396	233	82	1.2	30	0.4	13	0.2	4	0.1
WSPX035G <input type="checkbox"/> <input checked="" type="checkbox"/> FX-US	1 ½"	350	21	1260	742	57	0.8	24	0.3	5	0.1	5	0.1
WSPX040H <input type="checkbox"/> <input checked="" type="checkbox"/> FX-US	2"	350	21	1260	742	52	0.8	19	0.3	0	0.0	0	0.0
WSPX045I <input type="checkbox"/> <input checked="" type="checkbox"/> FX-US	2 ½"	350	21	1260	742	55	0.8	22	0.3	3	0.0	1	0.0
WSPX050I <input type="checkbox"/> <input checked="" type="checkbox"/> FX-US	2 ½"	800	48	2880	1695	116	1.7	57	0.8	16	0.2	5	0.1
WSPX055J <input type="checkbox"/> <input checked="" type="checkbox"/> FX-US	3"	800	48	2880	1695	111	1.6	52	0.8	11	0.2	0	0.0

Select for BSPP Threads / Select for NPT Threads

Product Selection & Correction Factors

To correctly select a separator model, the flow rate of the separator must be adjusted for the minimum operating (inlet) pressure at the point of installation.

1. Obtain the minimum operating (inlet) pressure and maximum compressed air flow rate at the inlet of the separator.
2. Select the correction factor for minimum inlet pressure from the CFMIP table (always round down e.g. for 77 psi g (5.3 bar g), use 73 psi g (5 bar g) correction factor.)
3. Calculate the minimum filtration capacity. Minimum Filtration Capacity = Compressed Air Flow Rate x CFP
4. Using the minimum filtration capacity, select a filter model from the flow rate tables above (filter selected must have a flow rate equal to or greater than the minimum filtration capacity).

CFMIP - Correction Factor Minimum Inlet Pressure

Minimum Inlet Pressure	bar g	1	2	3	4	5	6	7	8	9	10	11	12	13	14	15	16
	psi g	15	29	44	58	73	87	100	116	131	145	160	174	189	203	218	232
Correction Factor		4.00	2.63	2.00	1.59	1.33	1.14	1.00	0.94	0.89	0.85	0.82	0.79	0.76	0.73	0.71	0.68

Liquid Separators Tested In Accordance With

Filtration Grade	WS
Filter Type	Liquid Separator
Test Methods Used	ISO 8573-9:2004 ISO 12500-4:2009
ISO12500-4 Inlet Challenge Concentration	33 ml of liquid water per cubic meter of compressed air

Weight & Dimensions

WSPX Model	Height (H)		Width (W)		Depth (D)		Weight	
	mm	ins	mm	ins	mm	ins	kg	lbs
010	180	7.09	76	2.99	65	2.56	0.81	1.78
015 / 020	238	9.37	89	3.50	84	3.31	1.41	3.10
025	277	10.91	120	4.72	115	4.53	2.66	5.86
030	277	10.91	120	4.72	115	4.53	2.66	5.86
035/040/ 045	440	17.32	164	6.46	157	6.18	6.87	15.14
050	614	24.17	192	7.56	183	7.20	8.47	18.66
055	515	20.28	192	7.56	183	7.20	8.47	18.66

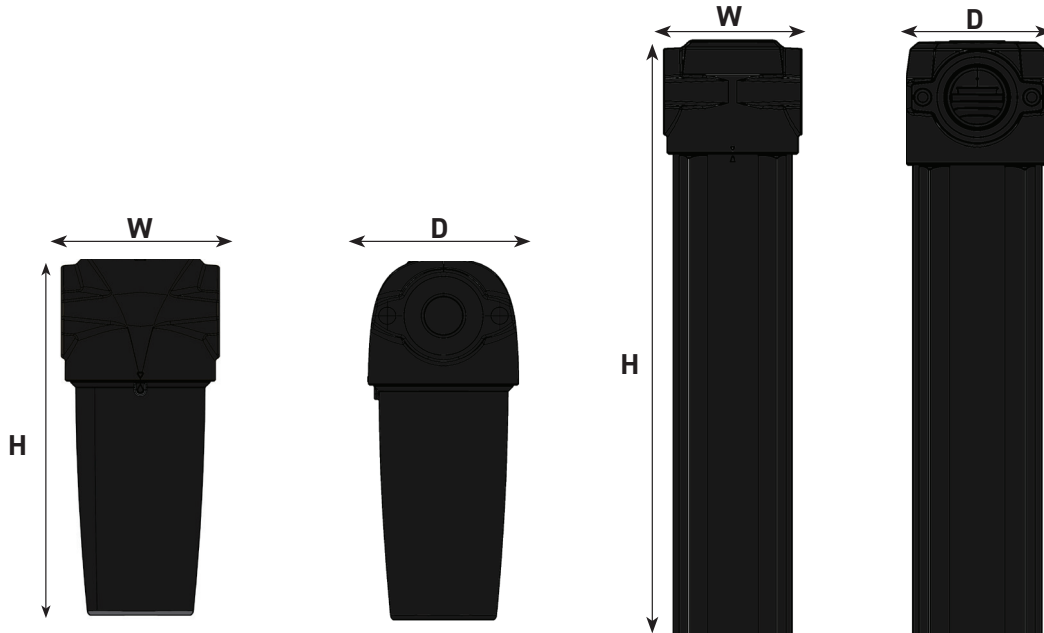

Quality Assurance / IP Rating / Pressure Vessel Approvals

Development / Manufacture	ISO 9001 / ISO 14001
Ingress Protection Rating	Not Applicable
EU	Pressure vessel approved for fluid group 2 in accordance with the Pressure Equipment Directive 2014/68/EU
USA	Approval to ASME VIII Div. 1 not required
AUS	Approval to AS1210 not required
RUSSIA	TR (formerly GOST-R)
For use with Compressed Air, N ₂ & CO ₂	

Grade AO General Purpose Coalescing Filter

Filtration Performance

Filtration Grade	Filter Type	Particle Reduction (inc water & oil aerosols)	Max Remaining Oil Content at 70°F (21°C)	Filtration Efficiency	Change Element Every	Precede with Filtration Grade
AO	Coalescing	Down to 1 micron	0.5 mg/m ³ 0.5 ppm(w)	99.925%	12 months	WS (for bulk liquid)

Technical Data

Filtration Grade	Filter Models	Min Operating Pressure		Max Operating Pressure		Min Operating Temperature		Max Operating Temperature	
		bar g	psi g	bar g	psi g	°C	°F	°C	°F
AO	PX010 - PX055 (Float Drain)	1.5	22	16	232	2	35	65	149
AO	PX010 - PX055 (Manual Drain)	1	15	20	290	2	35	80	176

Flow Rates Stated flows are for operation at 100 psi g (7 bar g) with reference to 68°F (20°C), 14.5 psi g (1 bar g), 0% relative water vapor pressure.

Model	Pipe Size	L/S	m ³ /min	m ³ /hr	cfm	Replacement Element	No.	Initial Saturated Differential Pressure							
								100% Flow		75% Flow		50% Flow		25% Flow	
								mbar	psi	mbar	psi	mbar	psi	mbar	psi
AOPX010A <input type="checkbox"/> G <input type="checkbox"/> N FX	½"	10	0.6	36	21	P010AO	1	123	1.8	84	1.2	53	0.8	27	0.4
AOPX010B <input type="checkbox"/> G <input type="checkbox"/> N FX	¾"	10	0.6	36	21	P010AO	1	124	1.8	85	1.2	55	0.8	30	0.4
AOPX010C <input type="checkbox"/> G <input type="checkbox"/> N FX	½"	10	0.6	36	21	P010AO	1	121	1.8	82	1.2	44	0.6	15	0.2
AOPX015B <input type="checkbox"/> G <input type="checkbox"/> N FX	¾"	20	1.2	72	42	P015AO	1	122	1.8	84	1.2	46	0.7	20	0.3
AOPX015C <input type="checkbox"/> G <input type="checkbox"/> N FX	½"	20	1.2	72	42	P015AO	1	91	1.3	53	0.8	31	0.4	13	0.2
AOPX020C <input type="checkbox"/> G <input type="checkbox"/> N FX	½"	30	1.8	108	64	P020AO	1	124	1.8	82	1.2	45	0.7	20	0.3
AOPX020D <input type="checkbox"/> G <input type="checkbox"/> N FX	¾"	30	1.8	108	64	P020AO	1	113	1.6	72	1.0	34	0.5	10	0.1
AOPX025D <input type="checkbox"/> G <input type="checkbox"/> N FX	¾"	60	3.6	216	127	P025AO	1	125	1.8	80	1.2	43	0.6	21	0.3
AOPX025E <input type="checkbox"/> G <input type="checkbox"/> N FX	1"	60	3.6	216	127	P025AO	1	80	1.2	50	0.7	27	0.4	11	0.2
AOPX030E <input type="checkbox"/> G <input type="checkbox"/> N FX	1"	110	6.6	396	233	P030AO	1	125	1.8	80	1.2	42	0.6	30	0.4
AOPX030G <input type="checkbox"/> G <input type="checkbox"/> N FX	1 ½"	110	6.6	396	233	P030AO	1	90	1.3	49	0.7	27	0.4	9	0.1
AOPX035G <input type="checkbox"/> G <input type="checkbox"/> N FX	1 ½"	160	9.6	576	339	P035AO	1	81	1.2	44	0.6	18	0.3	5	0.1
AOPX040H <input type="checkbox"/> G <input type="checkbox"/> N FX	2"	220	13.2	792	466	P040AO	1	113	1.6	69	1.0	40	0.6	20	0.3
AOPX045H <input type="checkbox"/> G <input type="checkbox"/> N FX	2"	330	19.8	1188	699	P045AO	1	123	1.8	81	1.2	44	0.6	21	0.3
AOPX045I <input type="checkbox"/> G <input type="checkbox"/> N FX	2 ½"	330	19.8	1188	699	P045AO	1	95	1.4	64	0.9	35	0.5	15	0.2
AOPX050I <input type="checkbox"/> G <input type="checkbox"/> N FX	2 ½"	430	25.9	1548	911	P050AO	1	116	1.7	75	1.1	42	0.6	17	0.2
AOPX055I <input type="checkbox"/> G <input type="checkbox"/> N FX	2 ½"	620	37.3	2232	1314	P055AO	1	123	1.8	81	1.2	45	0.7	24	0.3
AOPX055J <input type="checkbox"/> G <input type="checkbox"/> N FX	3"	620	37.3	2232	1314	P055AO	1	112	1.6	55	0.8	32	0.5	17	0.2

Select G for BSPP Threads / Select N for NPT Threads

When selecting a coalescing filter for pressures above 232 psi g (16 bar g), use manual drain version and fit an external automatic drain. Differential pressure gauge not included as standard. Models 035-055 can be fitted with a gauge. Order part number ZD90GL (ships loose for field install). Models 010-030 cannot be fitted with a gauge.

Product Selection & Correction Factors

To correctly select a filter model, the flow rate of the filter must be adjusted for the minimum operating (inlet) pressure at the point of installation.

- Obtain the minimum operating (inlet) pressure and maximum compressed air flow rate at the inlet of the filter.
- Select the correction factor for minimum inlet pressure from the CFMIP table (always round down e.g. for 77 psi g (5.3 bar g), use 73 psi g (5 bar g) correction factor).
- Calculate the minimum filtration capacity. Minimum Filtration Capacity = Compressed Air Flow Rate x CFMIP
- Using the minimum filtration capacity, select a filter model from the flow rate tables above (filter selected must have a flow rate equal to or greater than the minimum filtration capacity).

CFMIP - Correction Factor Minimum Inlet Pressure

Minimum Inlet Pressure	bar g	1	2	3	4	5	6	7	8	9	10	11	12	13	14	15	16	17	18	19	20
	psi g	15	29	44	58	73	87	100	116	131	145	160	174	189	203	218	232	248	263	277	290
Correction Factor		2.65	1.87	1.53	1.32	1.18	1.08	1.00	0.94	0.88	0.84	0.80	0.76	0.73	0.71	0.68	0.66	0.64	0.62	0.61	0.59

Grade AA High Efficiency Coalescing Filter

Filtration Performance

Filtration Grade	Filter Type	Particle Reduction (inc water & oil aerosols)	Max Remaining Oil Content at 70°F (21°C)	Filtration Efficiency	Change Element Every	Precede with Filtration Grade
AA	Coalescing	Down to 0.01 micron	0.01 mg/m ³ 0.01 ppm(w)	99.9999%	12 months	AO

Technical Data

Filtration Grade	Filter Models	Min Operating Pressure		Max Operating Pressure		Min Operating Temperature		Max Operating Temperature	
		bar g	psi g	bar g	psi g	°C	°F	°C	°F
AA	PX010 - PX055 (Float Drain)	1.5	22	16	232	2	35	65	149
AA	PX010 - PX055 (Manual Drain)	1	15	20	290	2	35	80	176

Flow Rates Stated flows are for operation at 100 psi g (7 bar g) with reference to 68°F (20°C), 14.5 psi g (1 bar g), 0% relative water vapor pressure.

Model	Pipe Size	L/S	m ³ /min	m ³ /hr	cfm	Replacement Element	No.	Initial Saturated Differential Pressure							
								100% Flow		75% Flow		50% Flow		25% Flow	
								mbar	psi	mbar	psi	mbar	psi	mbar	psi
AAPX010A <input type="checkbox"/> FX	½"	10	0.6	36	21	P010AA	1	117	1.7	83	1.2	50	0.7	25	0.4
AAPX010B <input type="checkbox"/> FX	¾"	10	0.6	36	21	P010AA	1	121	1.8	85	1.2	52	0.8	27	0.4
AAPX010C <input type="checkbox"/> FX	½"	10	0.6	36	21	P010AA	1	111	1.6	75	1.1	41	0.6	20	0.3
AAPX015B <input type="checkbox"/> FX	¾"	20	1.2	72	42	P015AA	1	115	1.7	79	1.1	44	0.6	24	0.3
AAPX015C <input type="checkbox"/> FX	½"	20	1.2	72	42	P015AA	1	80	1.2	51	0.7	27	0.4	12	0.2
AAPX020C <input type="checkbox"/> FX	½"	30	1.8	108	64	P020AA	1	122	1.8	80	1.2	41	0.6	18	0.3
AAPX020D <input type="checkbox"/> FX	¾"	30	1.8	108	64	P020AA	1	100	1.5	60	0.9	37	0.5	24	0.3
AAPX025D <input type="checkbox"/> FX	¾"	60	3.6	216	127	P025AA	1	86	1.2	57	0.8	33	0.5	10	0.1
AAPX025E <input type="checkbox"/> FX	1"	60	3.6	216	127	P025AA	1	66	1.0	45	0.7	25	0.4	10	0.1
AAPX030E <input type="checkbox"/> FX	1"	110	6.6	396	233	P030AA	1	122	1.8	82	1.2	42	0.6	11	0.2
AAPX030G <input type="checkbox"/> FX	1 ½"	110	6.6	396	233	P030AA	1	104	1.5	55	0.8	30	0.4	10	0.1
AAPX035G <input type="checkbox"/> FX	1 ½"	160	9.6	576	339	P035AA	1	75	1.1	45	0.7	20	0.3	5	0.1
AAPX040H <input type="checkbox"/> FX	2"	220	13.2	792	466	P040AA	1	90	1.3	60	0.9	40	0.6	20	0.3
AAPX045H <input type="checkbox"/> FX	2"	330	19.8	1188	699	P045AA	1	108	1.6	71	1.0	35	0.5	12	0.2
AAPX045I <input type="checkbox"/> FX	2 ½"	330	19.8	1188	699	P045AA	1	108	1.6	70	1.0	32	0.5	15	0.2
AAPX050I <input type="checkbox"/> FX	2 ½"	430	25.9	1548	911	P050AA	1	90	1.3	66	1.0	43	0.6	18	0.3
AAPX055I <input type="checkbox"/> FX	2 ½"	620	37.3	2232	1314	P055AA	1	119	1.7	78	1.1	44	0.6	21	0.3
AAPX055J <input type="checkbox"/> FX	3"	620	37.3	2232	1314	P055AA	1	104	1.5	52	0.8	25	0.4	17	0.2

Select for BSPP Threads / Select for NPT Threads

When selecting a coalescing filter for pressures above 232 psi g (16 bar g), use manual drain version and fit an external automatic drain.

Differential pressure gauge not included as standard. Models 035-055 can be fitted with a gauge. Order part number ZD90GL (ships loose for field install). Models 010-030 cannot be fitted with a gauge.

Filtration Tested In Accordance With

Filtration Grade	AO with float drain	AA with float drain
Filter Type	Coalescing	Coalescing
Test Methods Used	ISO 8573-2:2018 ISO 8573-4: 2019 ISO 12500-1:2007	ISO 8573-2:2018 ISO 8573-4: 2019 ISO 12500-1:2007
ISO12500-1 Inlet Challenge Concentration	40 mg of oil aerosol per cubic metre of compressed air	10 mg of oil aerosol per cubic metre of compressed air

OIL-X Grade AO & AA Oil Carryover versus Flow

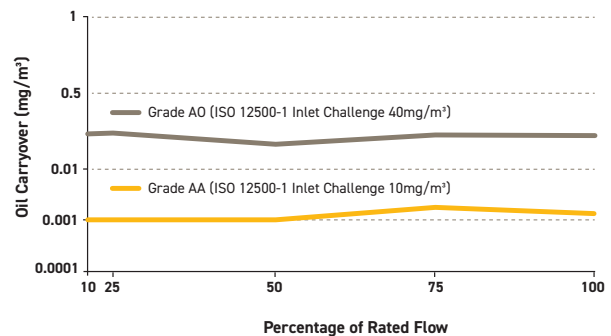

Grade AO General Purpose Dry Particulate Filter

Filtration Performance

Filtration Grade	Filter Type	Particle Reduction (inc water & oil aerosols)	Max Remaining Oil Content at 70°F (21°C)	Filtration Efficiency	Change Element Every	Precede with Filtration Grade
AO	Dry Particulate	Down to 1 micron	Not Applicable	99.925%	12 months	Not Applicable

Technical Data

Filtration Grade	Filter Models	Min Operating Pressure		Max Operating Pressure		Min Operating Temperature		Max Operating Temperature	
		bar g	psi g	bar g	psi g	°C	°F	°C	°F
AO	PX010 - PX055 (Float Drain)	1.5	22	16	232	2	35	65	149
AO	PX010 - PX055 (Manual Drain)	1	15	20	290	2	35	80	176

Flow Rates Stated flows are for operation at 100 psi g (7 bar g) with reference to 68°F (20°C), 14.5 psi g (1 bar g), 0% relative water vapor pressure.

Model	Pipe Size	L/S	m³/min	m³/hr	cfm	Replacement Element	No.	Initial Saturated Differential Pressure							
								100% Flow		75% Flow		50% Flow		25% Flow	
								mbar	psi	mbar	psi	mbar	psi	mbar	psi
AOPX010A <input type="checkbox"/> N <input type="checkbox"/> MX	½"	10	0.6	36	21	P010AO	1	61	0.9	40	0.6	20	0.3	9	0.1
AOPX010B <input type="checkbox"/> N <input type="checkbox"/> MX	¾"	10	0.6	36	21	P010AO	1	63	0.9	43	0.6	22	0.3	11	0.2
AOPX010C <input type="checkbox"/> N <input type="checkbox"/> MX	½"	10	0.6	36	21	P010AO	1	58	0.8	35	0.5	20	0.3	11	0.2
AOPX015B <input type="checkbox"/> N <input type="checkbox"/> MX	¾"	20	1.2	72	42	P015AO	1	60	0.9	38	0.6	23	0.3	12	0.2
AOPX015C <input type="checkbox"/> N <input type="checkbox"/> MX	½"	20	1.2	72	42	P015AO	1	27	0.4	15	0.2	10	0.1	5	0.1
AOPX020C <input type="checkbox"/> N <input type="checkbox"/> MX	½"	30	1.8	108	64	P020AO	1	58	0.8	35	0.5	15	0.2	8	0.1
AOPX020D <input type="checkbox"/> N <input type="checkbox"/> MX	½"	30	1.8	108	64	P020AO	1	38	0.6	20	0.3	10	0.1	5	0.1
AOPX025D <input type="checkbox"/> N <input type="checkbox"/> MX	¾"	60	3.6	216	127	P025AO	1	54	0.8	39	0.6	21	0.3	8	0.1
AOPX025E <input type="checkbox"/> N <input type="checkbox"/> MX	1"	60	3.6	216	127	P025AO	1	22	0.3	15	0.2	9	0.1	5	0.1
AOPX030E <input type="checkbox"/> N <input type="checkbox"/> MX	1"	110	6.6	396	233	P030AO	1	56	0.8	38	0.6	20	0.3	7	0.1
AOPX030G <input type="checkbox"/> N <input type="checkbox"/> MX	1 ½"	110	6.6	396	233	P030AO	1	42	0.6	26	0.4	12	0.2	6	0.1
AOPX035G <input type="checkbox"/> N <input type="checkbox"/> MX	1 ½"	160	9.6	576	339	P035AO	1	19	0.3	9	0.1	5	0.1	2	0.0
AOPX040H <input type="checkbox"/> N <input type="checkbox"/> MX	2"	220	13.2	792	466	P040AO	1	31	0.4	19	0.3	16	0.2	7	0.1
AOPX045H <input type="checkbox"/> N <input type="checkbox"/> MX	2"	330	19.8	1188	699	P045AO	1	51	0.7	36	0.5	18	0.3	8	0.1
AOPX045I <input type="checkbox"/> N <input type="checkbox"/> MX	2 ½"	330	19.8	1188	699	P045AO	1	40	0.6	27	0.4	12	0.2	6	0.1
AOPX050I <input type="checkbox"/> N <input type="checkbox"/> MX	2 ½"	430	25.9	1548	911	P050AO	1	36	0.5	23	0.3	16	0.2	7	0.1
AOPX055I <input type="checkbox"/> N <input type="checkbox"/> MX	2 ½"	620	37.3	2232	1314	P055AO	1	38	0.6	25	0.4	17	0.2	10	0.1
AOPX055J <input type="checkbox"/> N <input type="checkbox"/> MX	3"	620	37.3	2232	1314	P055AO	1	51	0.7	32	0.5	17	0.2	8	0.1

Select G for BSPP Threads / Select N for NPT Threads

Differential pressure gauge not included as standard. Models 035-055 can be fitted with a gauge. Order part number ZD90GL (ships loose for field install). Models 010-030 cannot be fitted with a gauge.

Product Selection & Correction Factors

To correctly select a filter model, the flow rate of the filter must be adjusted for the minimum operating (inlet) pressure at the point of installation.

1. Obtain the minimum operating (inlet) pressure and maximum compressed air flow rate at the inlet of the filter.
2. Select the correction factor for minimum inlet pressure from the CFMIP table (always round down e.g. for 77 psi g (5.3 bar g), use 73 psi g (5 bar g) correction factor).
3. Calculate the minimum filtration capacity. Minimum Filtration Capacity = Compressed Air Flow Rate x CFMIP
4. Using the minimum filtration capacity, select a filter model from the flow rate tables above (filter selected must have a flow rate equal to or greater than the minimum filtration capacity).

CFMIP - Correction Factor Minimum Inlet Pressure

Minimum Inlet Pressure	bar g	1	2	3	4	5	6	7	8	9	10	11	12	13	14	15	16	17	18	19	20
	psi g	15	29	44	58	73	87	100	116	131	145	160	174	189	203	218	232	248	263	277	290
Correction Factor		2.65	1.87	1.53	1.32	1.18	1.08	1.00	0.94	0.88	0.84	0.80	0.76	0.73	0.71	0.68	0.66	0.64	0.62	0.61	0.59

Grade AA High Efficiency Dry Particulate Filter

Filtration Performance

Filtration Grade	Filter Type	Particle Reduction (inc water & oil aerosols)	Max Remaining Oil Content at 70°F (21°C)	Filtration Efficiency	Change Element Every	Precede with Filtration Grade
AA	Not Applicable	Down to 0.01 micron	Not Applicable	99.9999%	12 months	AO Dry Particulate

Technical Data

Filtration Grade	Filter Models	Min Operating Pressure		Max Operating Pressure		Min Operating Temperature		Max Operating Temperature	
		bar g	psi g	bar g	psi g	°C	°F	°C	°F
AA	PX010 - PX055 (Float Drain)	1.5	22	16	232	2	35	65	149
AA	PX010 - PX055 (Manual Drain)	1	15	20	290	2	35	80	176

Flow Rates Stated flows are for operation at 100 psi g (7 bar g) with reference to 68°F (20°C), 14.5 psi g (1 bar g), 0% relative water vapor pressure.

Model	Pipe Size	L/S	m³/min	m³/hr	cfm	Replacement Element	No.	Initial Saturated Differential Pressure							
								100% Flow		75% Flow		50% Flow		25% Flow	
								mbar	psi	mbar	psi	mbar	psi	mbar	psi
AAPX010A	N MX ½"	10	0.6	36	21	P010AA	1	64	0.9	36	0.5	21	0.3	10	0.1
AAPX010B	N MX ¾"	10	0.6	36	21	P010AA	1	65	0.9	38	0.6	22	0.3	11	0.2
AAPX010C	N MX ½"	10	0.6	36	21	P010AA	1	63	0.9	39	0.6	20	0.3	10	0.1
AAPX015B	N MX ¾"	20	1.2	72	42	P015AA	1	66	1.0	41	0.6	21	0.3	12	0.2
AAPX015C	N MX ½"	20	1.2	72	42	P015AA	1	22	0.3	51	0.7	27	0.4	11	0.2
AAPX020C	N MX ½"	30	1.8	108	64	P020AA	1	64	0.9	41	0.6	18	0.3	8	0.1
AAPX020D	N MX ¾"	30	1.8	108	64	P020AA	1	42	0.6	22	0.3	10	0.1	5	0.1
AAPX025D	N MX ¾"	60	3.6	216	127	P025AA	1	27	0.4	19	0.3	10	0.1	4	0.1
AAPX025E	N MX 1"	60	3.6	216	127	P025AA	1	29	0.4	19	0.3	10	0.1	5	0.1
AAPX030E	N MX 1"	110	6.6	396	233	P030AA	1	62	0.9	49	0.7	25	0.4	8	0.1
AAPX030G	N MX 1 ½"	110	6.6	396	233	P030AA	1	45	0.7	27	0.4	13	0.2	5	0.1
AAPX035G	N MX 1 ½"	160	9.6	576	339	P035AA	1	22	0.3	10	0.1	5	0.1	2	0.0
AAPX040H	N MX 2"	220	13.2	792	466	P040AA	1	36	0.5	24	0.3	15	0.2	8	0.1
AAPX045H	N MX 2"	330	19.8	1188	699	P045AA	1	47	0.7	25	0.4	18	0.3	15	0.2
AAPX045I	N MX 2 ½"	330	19.8	1188	699	P045AA	1	47	0.7	30	0.4	17	0.2	8	0.1
AAPX050I	N MX 2 ½"	430	25.9	1548	911	P050AA	1	40	0.6	27	0.4	16	0.2	8	0.1
AAPX055I	N MX 2 ½"	620	37.3	2232	1314	P055AA	1	45	0.7	27	0.4	17	0.2	10	0.1
AAPX055J	N MX 3"	620	37.3	2232	1314	P055AA	1	54	0.8	35	0.5	17	0.2	9	0.1

Select G for BSPP Threads / Select N for NPT Threads

Differential pressure gauge not included as standard. Models 035-055 can be fitted with a gauge. Order part number ZD90GL (ships loose for field install). Models 010-030 cannot be fitted with a gauge.

Filtration Tested In Accordance With

Filtration Grade	AO with manual drain	AA with manual drain
Filter Type	Dry Particulate	Dry Particulate
Test Methods Used	ISO8573-4	ISO8573-4
ISO12500-1 Inlet Challenge Concentration	Not Applicable	Not Applicable

ISO8573-1:2010 Classifications for OIL-X Grades

ISO 8573-1:2010 CLASS	Solid Particulate		Water	Oil
	Wet Particulate	Dry Particulate	Vapor	Total Oil (aerosol liquid and vapor)
0	—	—	—	OIL-X Grades AO + AA + OVR
1	OIL-X Grades AO + AA	OIL-X Grades AO (M) + AA (M)	Dryer sized for ≤-70°C PDP	OIL-X Grades AO + AA + OVR OIL-X Grades AO + AA + ACS
2	OIL-X Grade AO	OIL-X Grade AO (M)	Dryer sized for ≤-40°C PDP	OIL-X Grades AO + AA
3	OIL-X Grade AO	OIL-X Grade AO (M)	Dryer sized for ≤-20°C PDP	OIL-X Grades AO
4	OIL-X Grade AO	OIL-X Grade AO (M)	Dryer sized for ≤+3°C PDP	OIL-X Grades AO
5	OIL-X Grade AO	OIL-X Grade AO (M)	Dryer sized for ≤+7°C PDP	—
6	—	—	Dryer sized for ≤+10°C PDP	—

OIL-X Grades AO & AA - Differential Pressure Curves

OIL-X Grade AO Coalescing Filter
 Initial Saturated Differential Pressure (25% - 100% Rated Flow)
 ISO12500-1 Challenge - 40mg/m³

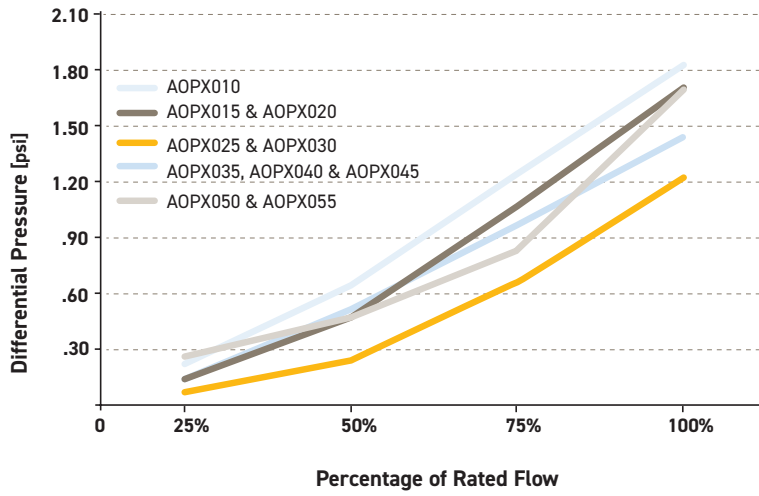

OIL-X Grade AA Coalescing Filter
 Initial Saturated Differential Pressure (25% - 100% Rated Flow)
 ISO12500-1 Challenge - 10mg/m³

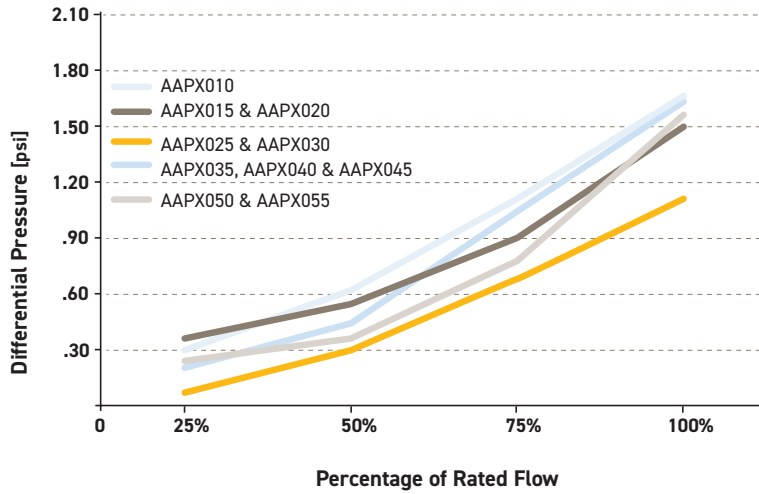

OIL-X Grade AO Dry Particulate Filter
 Initial Dry Differential Pressure (25% - 100% Rated Flow)

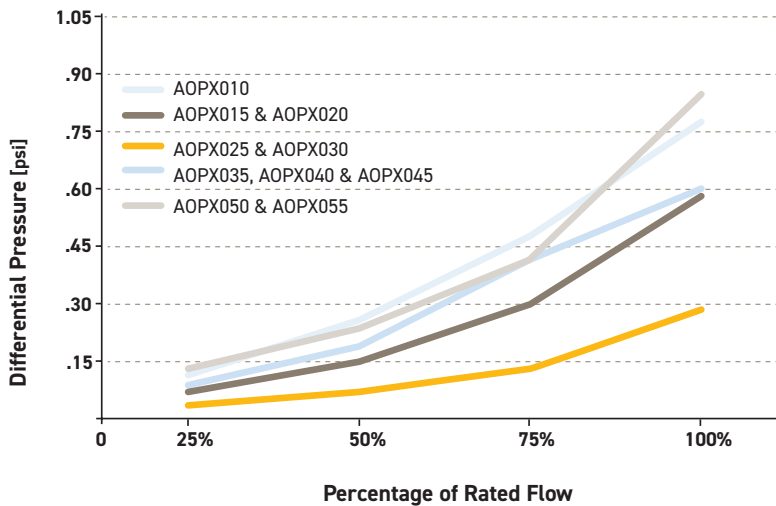

OIL-X Grade AA Dry Particulate Filter Initial Dry Differential Pressure (25% - 100% Rated Flow)

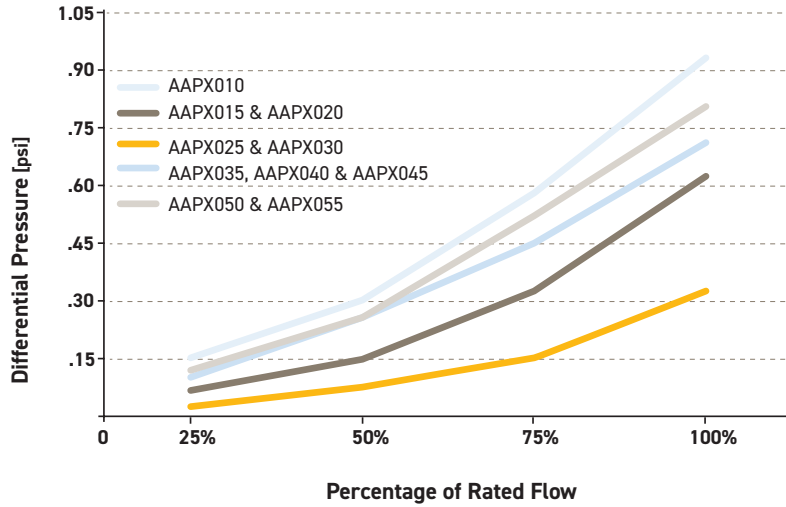

Weight & Dimensions

Model	Height (H)		Width (W)		Depth (D)		Weight	
	mm	ins	mm	ins	mm	ins	kg	lbs
010	180	7.09	76	2.99	65	2.56	0.81	1.78
015	238	9.37	89	3.50	84	3.31	1.41	3.10
020	238	9.37	89	3.50	84	3.31	1.41	3.10
025	277	10.91	120	4.72	115	4.53	2.66	5.86
030	367	14.45	120	4.72	115	4.53	3.01	6.63
035	440	17.32	164	6.46	157	6.18	6.87	15.14
040	532	20.94	164	6.46	157	6.18	7.18	15.82
045	532	20.94	164	6.46	157	6.18	7.18	15.82
050	654	25.75	192	7.56	183	7.20	10.18	22.43
055	844	33.23	192	7.56	183	7.20	15.78	34.78

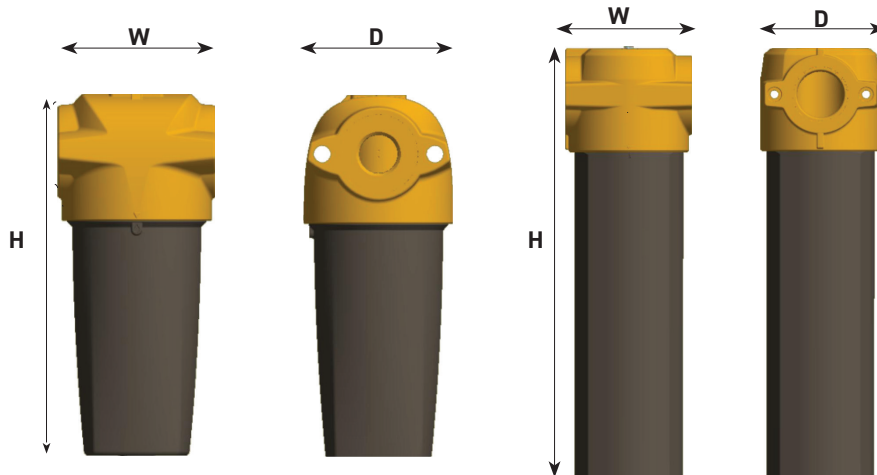

Quality Assurance / IP Rating / Pressure Vessel Approvals

Development / Manufacture	ISO 9001 / ISO 14001
Ingress Protection Rating	Not Applicable
EU	Pressure vessel approved for fluid group 2 in accordance with the Pressure Equipment Directive 2014/68/EU
USA	Approval to ASME VIII Div. 1 not required
AUS	Approval to AS1210 not required
RUSSIA	TR (formerly GOST-R)

For use with Compressed Air, N₂ & CO₂

Grade ACS Point of Use Oil Vapor Reduction Filters

Filtration Performance

Filtration Grade	Filter Type	Particle Reduction (inc water & oil aerosols)	Max Remaining Oil Content at 70°F (21°C)	Filtration Efficiency	Change Element Every	Precede with Filtration Grade
ACS	Oil Vapor Reduction	N/A	0.003 mg/m ³ 0.003 ppm(w)	N/A	When oil vapor is detected	A0+AA

Technical Data

Filtration Grade	Filter Models	Min Operating Pressure		Max Operating Pressure		Min Operating Temperature		Max Operating Temperature	
		bar g	psi g	bar g	psi g	°C	°F	°C	°F
ACS	PX010 - PX055 (Manual Drain)	1	15	20	290	2	35	50	122

Flow Rates Stated flows are for operation at 100 psi g (7 bar g) with reference to 68°F (20°C), 14.5 psi g (1 bar g), 0% relative water vapor pressure.

Model	Pipe Size	L/S	m ³ /min	m ³ /hr	cfm	Replacement Element	No.	Initial Saturated Differential Pressure							
								100% Flow		75% Flow		50% Flow		25% Flow	
								mbar	psi	mbar	psi	mbar	psi	mbar	psi
ACSPX010A <input type="checkbox"/> MX	½"	10	0.6	36	21	P010ACS	1	61	0.9	35	0.5	15	0.2	9	0.1
ACSPX010B <input type="checkbox"/> MX	¾"	10	0.6	36	21	P010ACS	1	53	0.8	32	0.5	19	0.3	8	0.1
ACSPX010C <input type="checkbox"/> MX	½"	10	0.6	36	21	P010ACS	1	55	0.8	31	0.4	18	0.3	7	0.1
ACSPX015B <input type="checkbox"/> MX	¾"	20	1.2	72	42	P015ACS	1	65	0.9	33	0.5	13	0.2	5	0.1
ACSPX015C <input type="checkbox"/> MX	½"	20	1.2	72	42	P015ACS	1	46	0.7	37	0.5	20	0.3	9	0.1
ACSPX020C <input type="checkbox"/> MX	½"	30	1.8	108	64	P020ACS	1	77	1.1	35	0.5	15	0.2	7	0.1
ACSPX020D <input type="checkbox"/> MX	¾"	30	1.8	108	64	P020ACS	1	79	1.1	37	0.5	17	0.2	8	0.1
ACSPX025D <input type="checkbox"/> MX	¾"	60	3.6	216	127	P025ACS	1	66	1.0	34	0.5	14	0.2	4	0.1
ACSPX025E <input type="checkbox"/> MX	1"	60	3.6	216	127	P025ACS	1	46	0.7	24	0.3	13	0.2	4	0.1
ACSPX030E <input type="checkbox"/> MX	1"	110	6.6	396	233	P030ACS	1	57	0.8	27	0.4	16	0.2	8	0.1
ACSPX030G <input type="checkbox"/> MX	1 ½"	110	6.6	396	233	P030ACS	1	65	0.9	35	0.5	15	0.2	5	0.1
ACSPX035G <input type="checkbox"/> MX	1 ½"	160	9.6	576	339	P035ACS	1	26	0.4	12	0.2	8	0.1	4	0.1
ACSPX040H <input type="checkbox"/> MX	2"	220	13.2	792	466	P040ACS	1	36	0.5	23	0.3	13	0.2	4	0.1
ACSPX045H <input type="checkbox"/> MX	2"	330	19.8	1188	699	P045ACS	1	49	0.7	34	0.5	17	0.2	6	0.1
ACSPX045I <input type="checkbox"/> MX	2 ½"	330	19.8	1188	699	P045ACS	1	68	1.0	40	0.6	20	0.3	6	0.1
ACSPX050I <input type="checkbox"/> MX	2 ½"	430	25.9	1548	911	P050ACS	1	50	0.7	30	0.4	15	0.2	5	0.1
ACSPX055I <input type="checkbox"/> MX	2 ½"	620	37.3	2232	1314	P055ACS	1	61	0.9	36	0.5	16	0.2	12	0.2
ACSPX055J <input type="checkbox"/> MX	3"	620	37.3	2232	1314	P055ACS	1	50	0.7	35	0.5	17	0.2	5	0.1

Select for BSPP Threads / Select for NPT Threads

Product Selection & Correction Factors

To correctly select a filter model, the flow rate of the filter must be adjusted for the minimum operating (inlet) pressure at the point of installation.

1. Obtain the minimum operating (inlet) pressure and maximum compressed air flow rate at the inlet of the filter.
2. Select the correction factor for minimum inlet pressure from the CFMIP table (always round down e.g. for 232 psi g (16 bar g)
3. Calculate the minimum filtration capacity. Minimum Filtration Capacity = Compressed Air Flow Rate x CFMIP
4. Using the minimum filtration capacity, select a filter model from the flow rate tables above (filter selected must have a flow rate equal to or greater than the minimum filtration capacity).

CFMIP - Correction Factor Minimum Inlet Pressure

Minimum Inlet Pressure	bar g	1	2	3	4	5	6	7	8	9	10	11	12	13	14	15	16	17	18	19	20
	psi g	15	29	44	58	73	87	100	116	131	145	160	174	189	203	218	232	248	263	277	290
Correction Factor		2.65	1.87	1.53	1.32	1.18	1.08	1.00	0.94	0.88	0.84	0.80	0.76	0.73	0.71	0.68	0.66	0.64	0.62	0.61	0.59

Filtration Tested In Accordance With

Filtration Grade	ACS
Filter Type	Oil Vapor Reduction
Test Methods Used	ISO8573-5
ISO8573-5 Inlet Challenge Concentration	0.018 mg of oil vapor per cubic meter of compressed air

Weight & Dimensions

Model	Height (H)		Width (W)		Depth (D)		Weight	
	mm	ins	mm	ins	mm	ins	kg	lbs
010	180	7.09	76	2.99	65	2.56	0.81	1.78
015	238	9.37	89	3.50	84	3.31	1.41	3.10
020	238	9.37	89	3.50	84	3.31	1.41	3.10
025	277	10.91	120	4.72	115	4.53	2.66	5.86
030	367	14.45	120	4.72	115	4.53	3.01	6.63
035	440	17.32	164	6.46	157	6.18	6.87	15.14
040	532	20.94	164	6.46	157	6.18	7.18	15.82
045	532	20.94	164	6.46	157	6.18	7.18	15.82
050	654	25.75	192	7.56	183	7.20	10.18	22.43
055	844	33.23	192	7.56	183	7.20	15.78	34.78

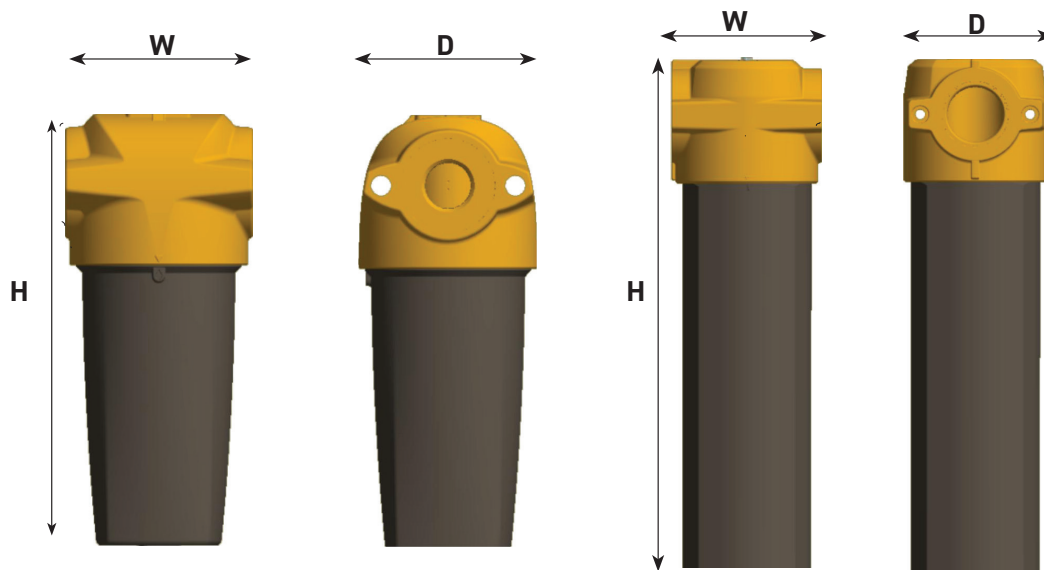

Quality Assurance / IP Rating / Pressure Vessel Approvals

Development / Manufacture	ISO 9001 / ISO 14001
Ingress Protection Rating	Not Applicable
EU	Pressure vessel approved for fluid group 2 in accordance with the Pressure Equipment Directive 2014/68/EU
USA	Approval to ASME VIII Div. 1 not required
AUS	Approval to AS1210 not required
RUSSIA	TR (formerly GOST-R)
For use with Compressed Air, N ₂ & CO ₂	

Grade OVR Plant Scale / Point of Use Oil Vapor Reduction Filters

Filtration Performance

Filtration Grade	Filter Type	Particle Reduction (inc Water & Oil Aerosols)	Max Remaining Oil Content*	Filtration Efficiency	Initial Dry Differential Pressure	Initial Saturated Differential Pressure	Adsorbent Life	Precede with Grade
OVR	Oil Vapor Reduction	N/A	≤ 0.003 mg/m ³ ≤ 0.003 ppm (w)	N/A	<350 mbar <5 psi	N/A	*12 months	AO + AA

*At system operating temperature and when corrected to match systems conditions.

Technical Data

Filtration Grade	Filter Models	Min Operating Pressure		Max Operating Pressure		Min Operating Temperature		Max Operating Temperature	
		bar g	psi g	bar g	psi g	°C	°F	°C	°F
OVR	P300H - P550I	1	15	16	232	2	35	50	122

Flow Rates Stated flows are for operation at 100 psi g (7 bar g) with reference to 68°F (20°C), 14.5 psi a (1 bar g), 0% relative water vapor pressure.

Model	Pipe Size	L/s	m ³ /min	m ³ /hr	cfm	Replacement Cartridge	No.	Differential Pressure (OVR Only)							
								100% Flow		75% Flow		50% Flow		25% Flow	
								mbar	psi	mbar	psi	mbar	psi	mbar	psi
OVRP300H <input type="checkbox"/> N <input type="checkbox"/> XX	2	80	4.8	289	170	P300OVR	1	350	5.1	198	2.9	46	0.7	11	0.2
OVRP350H <input type="checkbox"/> N <input type="checkbox"/> XX	2	163	9.8	586	345	P350OVR	1	350	5.1	198	2.9	46	0.7	11	0.2
OVRP400I <input type="checkbox"/> N <input type="checkbox"/> XX	2 ½"	326	19.6	1172	690	P400OVR	1	350	5.1	198	2.9	46	0.7	11	0.2
OVRP450I <input type="checkbox"/> N <input type="checkbox"/> XX	2 ½"	488	29.4	1758	1035	P450OVR	1	350	5.1	198	2.9	46	0.7	11	0.2
OVRP500I <input type="checkbox"/> N <input type="checkbox"/> XX	2 ½"	651	39.2	2345	1380	P500OVR	1	350	5.1	198	2.9	46	0.7	11	0.2
OVRP550I <input type="checkbox"/> N <input type="checkbox"/> XX	2 ½"	814	48.9	2931	1725	P550OVR	1								
2 x OVRP550I <input type="checkbox"/> N <input type="checkbox"/> XX	2 ½"	1629	97.9	5862	3451	P550OVR	2								
3 x OVRP550I <input type="checkbox"/> N <input type="checkbox"/> XX	2 ½"	2443	146.8	8793	5176	P550OVR	3								
4 x OVRP550I <input type="checkbox"/> N <input type="checkbox"/> XX	2 ½"	3257	195.8	11724	6901	P550OVR	4								
5 x OVRP550I <input type="checkbox"/> N <input type="checkbox"/> XX	2 ½"	4071	244.7	14656	8626	P550OVR	5								

Select G for BSPP Threads / Select N for NPT Threads

1 System Information Required for OVR Sizing & Selection

- Minimum pressure at the inlet of the OVR
- Compressor type (oil lubricated or oil free)
- Maximum inlet temperature at the inlet of the OVR (highest summer inlet temp)
- Maximum compressed air flow rate
- Dewpoint of the compressed air (i.e. is the proposed location of the unit before or after a compressed air dryer)
- Oil vapor concentration expected at the inlet of the OVR (default is 0.05 mg/m³)

2 Select correction factors

- For minimum inlet pressure, select a correction factor from the CFIP table that corresponds to the minimum inlet pressure of the compressed air system, remembering to always round down e.g. for 77 psi g (5.3 bar g) use the 73 psi g (5 bar g) correction factor.
- For maximum inlet temperature there are two tables, one for use with an oil lubricated compressor, the other for oil free compressor. Select a correction factor from the CFIT table for the relevant compressor type, remembering to always round up e.g. for 99°F (37°C) use the 104°F (40°C) correction factor.
- For pressure dewpoint, select a correction factor from the CFID table.
- For oil vapor concentration, select a correction factor from the CFIV table, remembering to always round up e.g. for 3.25g/m³ use the correction factor for 4mg/m³.

3 Calculate minimum filtration capacity

Minimum filtration Capacity = Compressed Air Flow x CFIT x CFMIP x CFID x CFIV

- Using the minimum filtration capacity, select an OVR model from the flow rate tables.
- The OVR model selected must have a flow rate equal to or greater than the minimum filtration capacity.
- If the minimum filtration capacity exceeds the maximum values of the models shown within the tables, please contact Parker for advice regarding larger multi-banked units.

Correction Factors Inlet Temperature (CFIT)

Oil lubricated compressors		
°C	°F	Correction Factor
25	77	1.00
30	86	1.00
35	95	1.00
40	104	1.25
45	113	1.55
50	122	1.90

Correction Factors Inlet Temperature (CFIT)

Oil free compressors		
°C	°F	Correction Factor
25	77	1.00
30	86	1.00
35	95	1.00
40	104	1.02
45	113	1.04
50	122	1.05

Correction Factor Minimum Inlet Pressure (CFMIP)

Minimum Inlet Pressure	bar g	3	4	5	6	7	8	9	10	11	12	13	14	15	16
	psi g	44	58	73	87	100	116	131	145	160	174	189	203	218	232
Correction Factor		2.00	1.60	1.33	1.14	1.00	1.00	1.00	1.00	1.00	1.00	1.00	1.00	1.00	1.00

Correction Factor - Dewpoint (CFID)

Installation	Correction Factor
After Dryer	1.00
Before Dryer	4.00

Correction Factor Inlet Vapor Content (CFIV)

Inlet Vapor Concentration mg/m ³	0.05	0.1	0.2	0.3	0.4	0.5	0.6	0.7	0.8	0.9	1.0	2.0	3.0	4.0	5.0
	Correction Factor	1	2	4	6	8	10	12	14	16	18	20	40	60	80

Weight & Dimensions

Models	Height (H)		Width (W)		Depth (D)		Weight	
	mm	ins	mm	ins	mm	ins	kg	lbs
OVRP300	998	39.3	534	21.0	350	13.8	38	84
OVRP350	1062	41.8	538	21.2	550	21.7	67	147
OVRP400	1062	41.8	682	26.9	550	21.7	93	205
OVRP450	1062	41.8	836	32.9	550	21.7	121	267
OVRP500	1062	41.8	1005	39.6	550	21.7	144	318
OVRP550	1062	41.8	1174	46.2	550	21.7	171	377

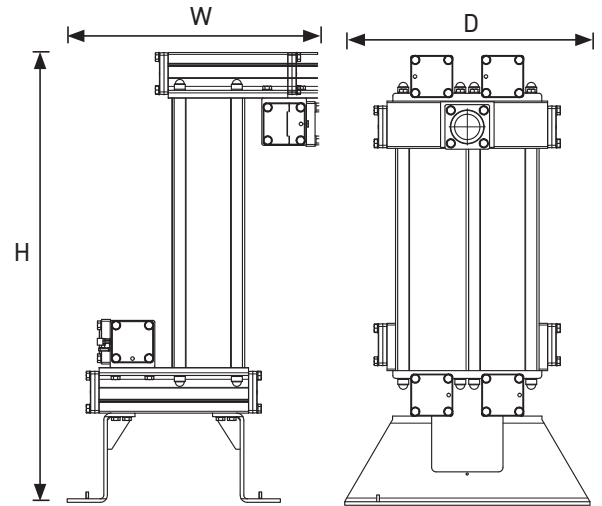

OVRP300 - OVRP550

Filtration Tested In Accordance With

Filtration Grade	OVR
Filter Type	Oil Vapor Reduction
Test Methods Used	ISO8573-5:2001
Oil Vapor Inlet Challenge Concentration	0.05 mg of oil vapor per cubic meter of compressed air

Quality Assurance / IP Rating / Pressure Vessel Approvals

Development / Manufacture	ISO 9001 / ISO 14001
Ingress Protection Rating	Not Applicable
EU	Pressure vessel approved for fluid group 2 in accordance with the Pressure Equipment Directive 2014/68/EU
USA	Approval to ASME VIII Div. 1 not required
AUS	Approval to AS1210 not required
GUS	TR (formerly GOST-R)

For use with Compressed Air & N₂

Parker Filtration Group

Aerospace Filtration Division
Greensboro, North Carolina
336 668 4444

**Bioscience & Water
Filtration Division**
Bioscience Filtration
Oxnard, California
877 784 2234

Water Purification
Carson, California
310 608 5600

**Engine Mobile
Aftermarket Division**
Kearney, Nebraska
308 234 1951

**Engine Mobile Original
Equipment Division**
Modesto, California
209 521 7860

HVAC Filtration Division
Jeffersonville, Indiana
866 247 4827

**Hydraulic & Fuel
Filtration Division**
Metamora, Ohio
419 644 4311

**Industrial Gas Filtration &
Generation Division**
Lancaster, NY
800 343 4048

**Industrial Process
Filtration Division**
Mineral Wells, Texas
940 325 2575

**Bioscience Engineering
Filtration Division EMEA**
Birtley, United Kingdom
+44 (0) 191 410 5121

**Engine Mobile Filtration
Division EMEA**
Dewsbury, United Kingdom
+44 (0) 1924 487 037

**Gas Separation &
Filtration Division EMEA**
Team Valley, United Kingdom
+44 (0) 191 402 9000

Gas Turbine Filtration Division
Alton, United Kingdom
+44 (0) 1420 541188

**Hydraulic & Industrial
Filtration Division EMEA**
Arnhem, Netherlands
+31 (0) 26 376 0376

Australia Filtration Division
Castle Hill, Australia
+61 2 9634 7777

China Filtration Division
Shanghai, China
+86 21 2067 2067

India Filtration Division
Chennai, India
+91 22 4391 0700

Korea Filtration Division
Hwaseon City, Korea
+82 31 359 0852

Latin America Filtration Division
Sao Paulo, Brazil
+55 12 4009 3500



© 2021 Parker Hannifin Corporation. Product names are trademarks or registered trademarks of their respective companies.

BROGSFEOLXDISTRGUIDE-03-USA



Parker Hannifin Corporation
**Industrial Gas Filtration
and Generation Division**
4087 Walden Avenue
Lancaster, NY 14086
phone 800 343 4048
www.parker.com/igfg