



aerospace  
climate control  
electromechanical  
filtration  
fluid & gas handling  
hydraulics  
pneumatics  
process control  
sealing & shielding



## Combination Moisture & Liquid Indicators

for Refrigerants 134a, 404A, 407A, 407C, 407F, 410A, 507, 744, 290, 1237ze, 448A, 449A, 450A, 513A, 32  
RACE Catalogue 70-10 Sight Glasses

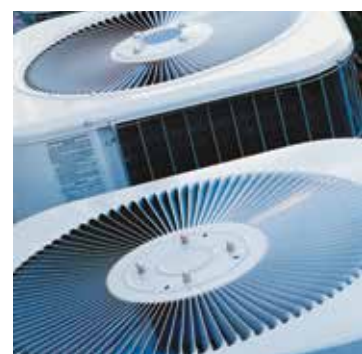

ENGINEERING YOUR SUCCESS.

The Parker Sporlan Moisture and Liquid Indicator combines the two functions of moisture and liquid indication into a single economical product. It takes the guess work out of servicing refrigeration and air conditioning equipment. See•All and KSG assist the technician in determining the state of the circulating refrigerant at a particular location and if a safe moisture level exists in the system. Excessive moisture in refrigerant systems can cause unwanted chemistries such as hydrolysis of lubricants and other materials, corrosion of metals, copper plating, ice formation at the meeting device and a chemical change in the motor insulation of a hermetic compressor.

*See•All*

## OUTSTANDING BENEFITS

### ONE INDICATOR for all REFRIGERANTS

Provides a true moisture indication for Refrigerant 134a, 404A, 407A, 407C, 407F, 410A, 507, 744, 290, 1234ze, 448A, 449A, 450A, 513A, 32.

### RELIABLE and ACCURATELY CALIBRATED COLOR CHANGE POINTS

In parts per million of moisture for each refrigerant.

### REPLACEABLE INDICATOR ELEMENT

The color indicator paper can be changed on fused glass models manufactured since 1984 without removing the See•All from the line.

### INDICATOR PROTECTED from DISCOLORATION and DIRT

By a filter pad and screen. This prevents washing of the indicator by the refrigerant and protects it from system contamination and turbulence.

### COLOR CHANGES ARE EASILY DISTINGUISHED and REVERSIBLE

Indicator colors differ so widely between the wet and dry condition, there is no possibility of confusion. Colors reverse as often as moisture concentration in the system changes.

### LARGE FULL VIEW SIGHTGLASS

Extra large crystal clear sightglass for viewing the refrigerant. Bubbles indicate a shortage of refrigerant or a restriction in the liquid line.

### DISASSEMBLY FOR INSTALLATION IS UNNECESSARY

With extended fittings on small size solder models.

See•Alls are easy to braze.

### PLASTIC CAP

Is supplied with See•All to keep the glass free from dust, dirt and grease.

### HOW IT'S MADE

The solid copper fittings are brazed to the plated body. A glass disc is inserted in the body and heated just to the melting point under carefully controlled conditions. This fuses the glass to the body in a permanent leak-free joint. The indicator paper (retained in a small brass ferrule) is inserted from the back and held in place with a slotted cylinder. The slotted cylinder and indicator assembly is mounted on a post that screws into the bottom of the body, and seals with a knife-edge joint. This overall construction is highly effective in preventing refrigerant leakage. The unit is painted to protect it from corrosion.

Paper indicator elements are made under the strictest quality control procedures. The indicator is tested for proper color change ability in the laboratory and twice more during assembly.

Figure 1

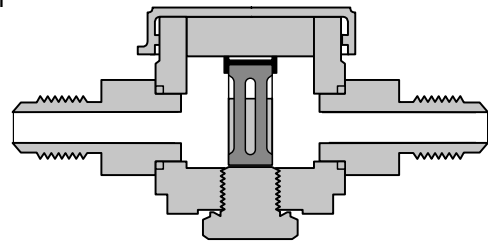

### HOW IT WORKS

The indicator is a porous filter paper impregnated with a chemical salt that is sensitive to moisture. The salt changes color according to the moisture content (relative saturation) in the refrigerant. A dark green color indicates the refrigerant is DRY and yellow indicates a WET condition. The indicator is formulated so that it changes color at the moisture levels generally accepted as the safe operating range.

The See•All calibration information in Table 1 is based on detailed experimental data for Refrigerants 134a, 404A, 407C, 407F, 410A, 507, 1234yf or 1234ze. The calibration information on other refrigerants was obtained from a comparison of their properties with these refrigerants. For Refrigerants 123, 401A and 402A: refrigerant 22 moisture calibration is suggested. For other refrigerants, contact RACE Business Unit.

MOISTURE CONTENT - PPM						
SEE • ALL SHOWS	Refrigerant 134a		Refrigerant 404A & 507		Refrigerant 407A, 407C & 407F	Refrigerant 410A
	24°C	38°C	24°C	38°C	24°C	24°C
● Green - DRY	≤50	≤80	≤15	≤30	≤120	≤75
● Chartreuse - CAUTION	50-200	80-225	15-90	30-140	120-280	75-150
● Yellow - WET	≥200	≥225	≥90	≥140	≥280	≥150

NOTE: Change or add Catch-All Filter-Drier when paper turns from green to chartreuse.

## FOR AIR

Tests on air show that the See•All changes color in the range of 0.5% to 2.0% R.H. In ordinary air lines this means that the See•All will change color at dew points in the range of minus 4°C to minus 16°C.

## BRAZING

See•Alls with 1/4" through 1-1/8" ODF Solder connections are constructed with long fittings made from either heavily copper plated steel or copper. Both fitting types are suitable for soldering or brazing using any of the common alloys, such as silver solder, soft solder, Sta-Brite, or Sil-Fos or PhosCopper. These See•Alls do not require disassembly in the field for brazing because the extended fittings reduce the possibility of damaging the moisture indicator element when the See•All is brazed into the system. To prevent damaging the See•All ensure ample heat is supplied to the fittings and point the torch tip away from the See•All body. Proper brazing technique ensures proper capillary action of the alloy.

The ODF Solder connections on the See•All are clean when shipped. Polishing the inside of the fittings before brazing is unnecessary.

The larger See•Alls with 1-3/8", 1-5/8", and 2-1/8" ODF Solder connections utilize copper connections and require removal of the cartridge from the brass saddle adaptor before brazing. The cartridge is shipped hand tight for easy removal.

The See•All may be installed anywhere in the the liquid line, but preferably after the Catch-All Filter-Drier and ahead of the metering device.

## APPLICATION

The indicator element of the See•All prior to installation will be yellow, indicating a wet condition. This is a normal situation since the air in contact with the element is above 0.5% Relative Humidity. This does not affect the operation or calibration of the See•All. As soon as it is installed in a system, the indicator element will begin to change according to the moisture content of the refrigerant. Some change may take place rapidly at the start-up of a new system or after replacement of a drier on existing installations. In some cases the See•All will change in as short a time as 15 minutes. However, it is recommended that the equipment operate for about 12 hours to allow the moisture in the system and the See•All color to come to complete equilibrium. The action of the indicator element is completely reversible and will change color as often as the moisture content of the system varies.

The drying of the system should be continued until the indicating element changes from chartreuse to green. The actual moisture content of the refrigerant will be in accordance with the above table.

For best results with the nickel plated SAE flare fittings that are used on See•Alls, lubricate the flare surface and the back of the flare nut with

refrigerant grade oil during assembly. This is particularly necessary to avoid leaks if the See•All is being assembled to another plated steel flare fitting, such as the Catch-All Filter-Drier.

## BYPASS INSTALLATION

On systems having liquid lines larger than 54 mm (2-1/8") O.D., the See•All should be installed in a bypass line. During the operating cycle this will provide sufficient flow to obtain a **satisfactory reading for both moisture and liquid indication.**

Best results will be obtained if the bypass line is parallel to the main liquid line and the take off and return tubes project into the main liquid line at a 45° angle.

## SERVICE POINTERS

### REPLACEMENT INDICATOR PAPER

Parker Sporlan kit K-SA-4 consisting of a slotted cylinder and indicator paper assembly is available for replacing the indicator in the fused glass style Parker Sporlan See•Alls (1/4" thru 1-1/8" sizes). Replacement is through the bottom (see Figure 1). If the indicator becomes damaged, it is generally recommended that the entire See•All be replaced. However, the parts kit can be used in situations where it is difficult to remove the See•All.

Figure 3

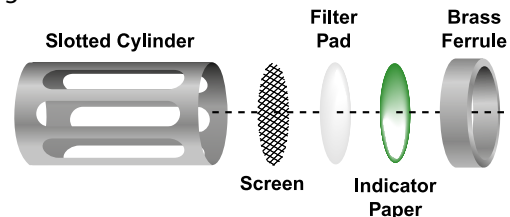

### LIQUID WATER

On occasion it is possible for large quantities of water to enter a refrigeration system. An example would be a broken tube in a water cooled condenser. If this happens and **free water** comes in contact with the indicator element, the element will be damaged.

All moisture indicating elements use a chemical salt (see "How it Works"). These salts must be soluble in water in order to change color. If **excessive water is present then the salts will dissolve causing permanent damage to the indicator.** The indicator paper may remain yellow or turn white.

### HERMETIC MOTOR BURNOUTS

After a hermetic motor burnout, install a Catch-All Filter-Drier to remove the acid and sludge contamination. When the system has operated for 48 hours, replace the Catch-All Filter-Drier and install a See•All.

Since the **acid formed by the burnout** may damage the indicator element of the See•All, it is preferable to install it after most of the contaminants have been removed.

## EXCESS OIL

When a system is circulating an excessive amount of oil, the See•All indicator paper may become saturated. This causes the indicator to appear brown or translucent and lose its ability to change color, but does not permanently damage the See•All. Let the See•All remain in the system. The circulating refrigerant will remove the excess oil, and the indicator element will return to its proper color.

## LEAK DETECTORS

Certain dye type liquid leak detectors may interfere with the color change of the indicator paper. If desired, many of these leak detectors can be removed by installing a Parker Sporlan HH style Catch-All in the liquid line. The See•All can then be installed on the system without risk of damaging the indicator paper.

## ALCOHOL

Do NOT install a See•All in a system that contains methyl alcohol or similar liquid dehydrating agents. Remove the alcohol by using a Catch-All Filter-Drier, and then install the See•All. Otherwise the alcohol will damage the See•All color indicator.

## REMOVABLE CARTRIDGE

Types SA-211, 213 and 217 have copper connections and feature a removable cartridge containing the moisture indicating element. The cartridge has a knife edge joint and is available as a separate unit for field replacement purposes if necessary. It is designated as AC-20 and fits all three sizes.



AC-20

## ATEX COMPLIANCE

The ODF solder models within this catalogue are designed to be used with A2L and A3 refrigerants (flammable) along with complying with the European Directives (97/23/CE) "Pressure Equipment Directive" and (94/9/CE) "ATEX Directive" for equipment intended for use in potentially explosive atmospheres.

Products bearing this mark have been evaluated and tested to the requirements found in the ATEX Directive 94/9/CE. The products will fall under "II 3 G TX Ta -46°C to +65°C" (-50°F to 149°F) and

are considered suitable for installation in potentially explosive atmospheres.

## INSTALLATION

For safety reasons, only authorized persons who are certified in installing and maintaining refrigeration and air conditioning systems containing flammable hydrocarbons must do the installation and maintenance. All local requirements or codes regarding use of hydrocarbons in refrigeration and air conditioning systems must be followed.

The refrigeration or air conditioning system must be designed so no abnormal impact (e.g. vibration, liquid hammer, pressure pulsations) can create risk for damage to the system.

When replacing parts, ONLY use Parker Hannifin replacement parts.

Parker Hannifin takes no responsibility for the classification of the refrigeration and/or air conditioning systems

## SAFETY

When used in a zone noted as Hazardous (ATEX), the possibility of Electrostatic charge build up on the external surface has to be prevented either during installation or service of this product. If the Parker Sporlan product must be handled, do so using a damp cloth in order to avoid electrostatic buildup.

Protect the Parker product against external impact that may cause a spark.

Personnel handling or working on or with this product must be qualified for that task. In an ATEX zone, the personnel must be educated in the risks of explosion. It is the responsibility of the installer to check the installation so that there is no leakage after it is installed, especially in case of explosive atmospheres. The valve and its control must not undergo any modification without prior approval from the Parker Sporlan Division. Parker Sporlan is not responsible for any damage which may be caused by the misuse or installation of our parts, accessories or controls which are not original parts.

**TABLE 1, ATEX COMPLIANT MODELS**

SEE-ALL MODEL	
SA-12S	SA-17S
SA-13S	SA-19S
SA-14S	SA-211
SA-15S	SA-213
	SA-217

**TABLE 2, MOISTURE CONTENT COLOR CHANGE POINTS**

REFRIGERANT	R-290		R-407A/R-	R-744	R-1234ze	
TEMP	75	100	75	20	75	100
Green - DRY	<15	<45	<120	<40	<40	<55
Chartreuse - CAUTION	15-30	45-60	120-280	40-65	40-80	55-120
Yellow - WET	>30	>60	>280	>65	>80	>120

Table 2 has the color change points for the See-All series in the subject refrigerants. Other parameters reviewed for these refrigerants but not affected and remain per Sporlan Bulletin 40-10:



- Maximum rated pressure
- Burst pressure
- Corrosion resistance



## Technical Data

### SEE ALL Sight Glasses

#### Dimensions, Weight and Packaging

Part Number	Connection Sizes (in.)	Type No.	Overall Length	<i>See-All</i>	Dimensions mm		Weight	Quantity Master Box
					Lay in length A	Height H		
<b>Connection SAE Male x Male</b>								
700000	1/4"	SA-12	73		-	35	0.2	25
700078	3/8"	SA-13	86		-	35	0.2	25
700247	1/2"	SA-14	97		-	41	0.3	25
700403	5/8"	SA-15	105		-	41	0.3	25
<b>Connection SAE Female x Male</b>								
700026	1/4"	SA-12FM	65		-	35	0.2	25
700091	3/8"	SA-13FM	75		-	35	0.2	25
700260	1/2"	SA-14FM	87		-	41	0.3	25
<b>Connection SAE Female swivel nut x Male</b>								
700195	3/8"	SA-13U	80		-	35	0.2	25
700364	1/2"	SA-14U	93		-	41	0.3	25
700468	5/8"	SA-15U	99		-	41	0.3	25
<b>Connection SAE Female swivel nut x Female swivel nut</b>								
700221	3/8"	SA-13UU	76		-	35	0.2	25
700377	1/2"	SA-14UU	90		-	41	0.3	25
700481	5/8"	SA-15UU	93		-	41	0.4	25
<b>Connection SAE Female swivel nut x Female</b>								
700117	3/8"	SA-13FU	71		-	35	0.2	25
700273	1/2"	SA-14FU	84		-	41	0.3	25
<b>Connection SAE Female swivel nut x ODF</b>								
700169	3/8"	SA-13SU	97		83	35	0.2	25
700338	1/2"	SA-14SU	107		93	41	0.3	25
700455	5/8"	SA-15SU	109		91	41	0.3	25
<b>Connection ODFx ODF</b>								
700052	1/4"	SA-12S	118		99	35	0.2	25
700130	3/8"	SA-13S	118		95	35	0.2	25
700299	1/2"	SA-14S	124		97	41	0.3	25
700416	5/8"	SA-15S	124		93	41	0.3	25
700507	7/8"	SA-17S	161		125	54	0.4	25
700546	1-1/8"	SA-19S	161		117	54	0.4	25
700585	1-3/8"	SA-211	203		154	68	0.6	12
700598	1-5/8"	SA-213	203		148	77	0.6	12
700611	2-1/8"	SA-217	203		140	90	0.8	12

## SEE ALL

### Calibration information

MOISTURE CONTENT – PPM				
REFRIGERANT	LIQUID LINE TEMPERATURE	SEE • ALL SHOWS		
		Green - DRY	Chartreuse - CAUTION	Yellow - WET
R-32	75°F / 24°C	↓125	125-500	↑500
	100°F / 38°C	↓145	145-580	↑580
R-134a	75°F / 24°C	↑50	50-200	↑200
	100°F / 38°C	↓80	80-225	↑225
R-290	75°F / 24°C	↓15	15-30	↑30
	100°F / 38°C	↓45	45-60	↑60
R-404A	75°F / 24°C	↓15	15-90	↑90
R-507	100°F / 38°C	↓30	30-140	↑140
R-407A R-407C R-407F	75°F / 24°C	↓120	120-280	↑280
R-410A	75°F / 24°C	↓75	75-150	↑150
R-448A	75°F / 24°C	↓45	45-150	↑150
R-449A	100°F / 38°C	↓50	50-255	↑255
R-450A	75°F / 24°C	↓30	30-90	↑90
R-513A*	100°F / 38°C	↓50	50-150	↑150
R-744	20°F / -7°C	↓40	40-65	↑65
R-1234ze	75°F / 24°C	↓40	40-80	↑80
	100°F / 38°C	↓55	55-120	↑120

NOTE: Change or add Catch-All Filter-Drier when paper turns from green to chartreuse.

## PARKER KSG SERIES

**Parker KSG moisture and Liquid Line Sight Glasses** allow a visual indication of colour, flow and refrigerant quality in a refrigeration or air-conditioning systems.

**KSG moisture and Liquid Line Sight Glasses** are a combination of brass body and large diameter fused bezel fitted in upper part and containing moisture indicator.

**KSG moisture and Liquid Line Sight Glasses** with solder connections use a long copper tubes

to facilitate brazing without dismounting the glass. However we recommend to protect the glass by calorie discharger **TB2 Thermal Block™** or to wrap with a damp cloth. The sight glass can be easily removed and replaced if necessary.

**Long copper connection and removable bezel are the guarantee to install and use with maximum performances and visualisation of refrigerant quality.**

### Benefits

<b>PS (MWP)</b>	<b>45 bar (652 psig)</b>
TS	-40°C to 60°C

• Leak Testing: 100% helium leak tested

• Approvals: PED 97/23/EC - article 3.3

### Features

Suitable for all CFC / HCFC / HFC refrigerant and their associated oils.

KSG Colour Indication	Moisture Content - ppm							
	R410A		R134a		R404A - R507		R407C	
	24°C	52°C	24°C	52°C	24°C	52°C	24°C	52°C
<b>Green- Dry</b>	75	135	30	60	40	85	30	70
<b>Yellow - Wet</b>	150	250	125	200	140	400	115	230

# Technical Data KSG Sight Glasses

## Dimensions, Weight and Packaging

Part Number	KSG Model	Connections		Dimensions mm			Weight Kg	Quantity Master Box	
		SAE	ODF	Overall length L	Lay in length A	Height H			
KSG 2F		1/4"	-	81	-	28	0.2	25	
KSG 3F		3/8"	-	81	-	28	0.2	25	
KSG 4F		1/2"	-	83	-	33	0.2	25	
KSG 5F		5/8"	-	93	-	35	0.4	25	
KSG 6F		3/4"	-	97	-	38	0.4	25	
KSG 2MF			1/4"	-	77	-	28	0.3	25
KSG 3MF	3/8"		-	80	-	33	0.3	25	
KSG 4MF	1/2"		-	87	-	35	0.3	25	
KSG 5MF	5/8"		-	91	-	39	0.4	25	
KSG 2S			-	1/4"	147	133	28	0.1	25
KSG 3S		-	3/8"	147	129	28	0.1	25	
KSG 4S		-	1/2"	161	141	35	0.2	25	
KSG 5S		-	5/8"	161	136	35	0.2	25	
KSG 6S		-	3/4"	171	143	35	0.3	25	
KSG 7S		-	7/8"	175	141	45	0.4	25	
KSG 9S		-	1" 1/8"	175	135	45	0.4	25	
KSG 6mmS			-	6mm	147	133	28	0.1	25
KSG 10mmS			-	10mm	147	129	28	0.1	25
KSG 12mmS			-	12mm	161	141	35	0.2	25
KSG 5S	-		16mm	161	136	35	0.2	25	
KSG4SSE			-	1/2"	57	43	35	0.1	50
KSG5SSE		-	5/8"	57	43	35	0.1	50	
KSG6SSE		-	3/4"	57	43	35	0.1	50	
KSGST5		-	5/8"	5/8"	16	26	0.1	75	
KSGST7		-	3/4"	7/8"	22	26	0.1	75	
KSGST9		-	7/8"	1" 1/8"	28	26	0.1	75	
KSGST11		-	1" 1/8"	1" 3/8"	35	26	0.1	75	
KSGST13		-	1" 5/8"	1" 5/8"	42	26	0.1	75	
KSGST17		-	2" 1/8"	2" 1/8"	54	26	0.1	75	

F = SAE (FLARE) Male

MF = SAE Female/Male

S = ODF (Inch)

mmS = ODF (mm)

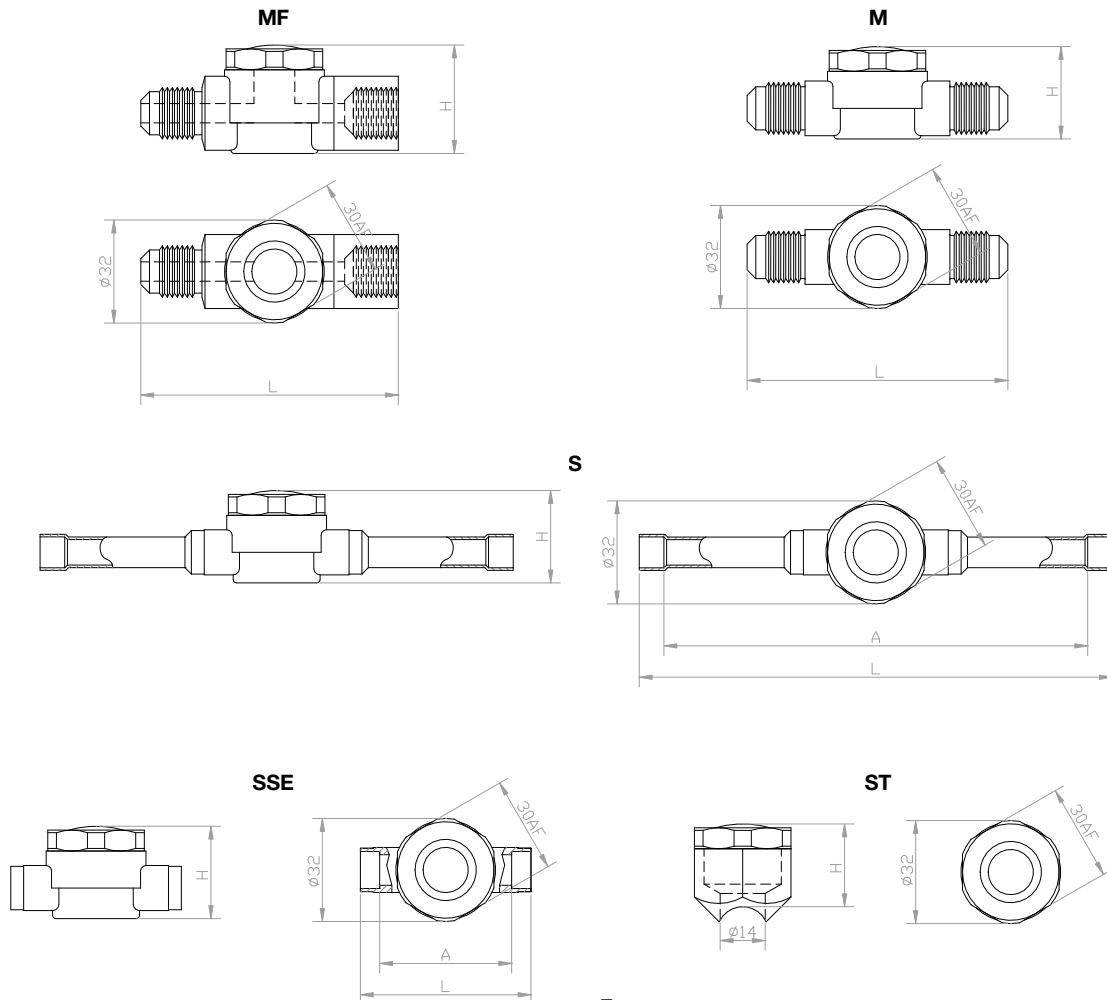

# Parker Worldwide

## United Arab Emirates

### Middle East

Sarkis OHANNESSIAN

Tel +961 3334622

sohannessian@parker.com

## Germany and German speaking part of Switzerland

Francesco GALANTE

Tel +49 (0)175 5756032

francesco.galante@parker.com

## Spain and Portugal

Alberto PEÑA

Tel +34 609 153 154

alberto.pena@parker.com

## France, Belgium,

### North Africa

## French speaking part of Switzerland

Eliane EMERIT-BONNOT

Tel +33 (0)6 73 89 36 01

ebonnot@parker.com

## Italy, Greece, Malta, Cyprus

## Italian speaking part of Switzerland

Andrea BRAGA

Tel +39 334 6944386

abraga@parker.com

## Turkey

parker.turkey@parker.com

## Ireland

Sean BRETT

Tel +353 (0) 1 868 9606

sbrett@parker.com

## Baltic Countries, UK, Northern Europe, South Africa

Kenny ADAMSON

Tel +44 77853 71229

kadamson@parker.com

## Customer Service:

### Parker Hannifin Ltd

*Instrumentation Group*

*Refrigeration and*

*Air Conditioning Europe*

Manvers House

Office 21

Pioneer Close

Wath Upon Dearne

Rotherham S63 7JZ

United Kingdom

Tel +44 (0) 1709 774600

Fax +44 (0) 1709 774601

racecustomerservice@parker.com

[www.parker.com/race](http://www.parker.com/race)

#### WARNING - USER RESPONSIBILITY

Failure or improper selection or improper use of the products described herein or related items can cause death, personal injury and property damage.

This document and other information from Parker Hannifin Corporation, its subsidiaries and authorized distributors provide product or system options for further investigation by users having technical expertise.

The user, through its own analysis and testing, is solely responsible for making the final selection of the system and components and assuring that all performance, endurance, maintenance, safety and warning requirements of the application are met. The user must analyze all aspects of the application, follow applicable industry standards, and follow the information concerning the product in the current product catalog and in any other materials provided from Parker or its subsidiaries or authorized distributors.

To the extent that Parker or its subsidiaries or authorized distributors provide component or system options based upon data or specifications provided by the user, the user is responsible for determining that such data and specifications are suitable and sufficient for all applications and reasonably foreseeable uses of the components or systems.

For safety information see the Safety Guide at [www.parker.com/safety](http://www.parker.com/safety)

#### OFFER OF SALE

Please, contact your Parker representation for a detailed "Offer of Sale"  
FOR USE ON REFRIGERATION and/or AIR CONDITIONING SYSTEMS ONLY

