

VSO[®]-LP

Pressure Controllers

Long Performance Miniature Pressure Controllers



Typical Applications

- Pneumatic Motion Control
- Industrial Process Pressure Supply
- Pilot Pressure Generation

Designed for industrial and OEM instrument applications, the VSO[®]-LP Long Performance Pressure Controller delivers integral closed loop proportional control with the highest level of accuracy and stability. With an extra internal exhaust valve, the VSO[®]-LP provides rapid depressurization and response for precise pressure control. The VSO[®]-LP offers the flexibility to control pressure or flow, replacing manual regulators, flow controllers, and needle valves. This product uses Parker Hannifin's patented VSO[®] proportional valve for precise and consistent performance.

Features

- Integrated exhaust valve provides rapid depressurization and response
- Tested for long life to improve system availability
- Low power consumption reducing heat generation
- Customer configurable for pressure control or flow control
- Offers silent operation to reduce overall system noise
- Analog control for added design flexibility
- RoHS compliant 

Product Specifications

Physical Properties

Valve Technology:	Thermally compensated proportional valve, solenoid exhaust valve
Media:	Non-corrosive gases
Operating Environment:	32 to 131°F (0 to 55°C)
Storage Temperature:	-40 to 149°F (-40 to 65°C)
Length:	1.49 in (37.8 mm)
Width:	1.58 in (40.1 mm)
Height:	2.78 in (70.6 mm)
Weight:	6.2 oz (183.4 g)
Porting:	10-32 female ports Metric adaptor available

Electrical

Power:	24 VDC \pm 10%
Input Control Signal:	0-5 VDC standard
Monitor Output Voltage:	0-5 VDC
Current Requirement:	<550 mA
Electrical Connector:	Molex 6 pin miniature connector

Wetted Materials

Manifold:	AL 6061-T6, FKM, 302 Series SS
Valve:	FKM, 300 Series SS Brass 36000HT
Tubing:	Ester Based Polyurethane
Sensor:	Glass, Silicon, Silicone, Polyphenylene Sulfide

Performance Characteristics

Pressure Ranges:	0-15 psig (0-1.03 bar) 0-100 psig (0-6.89 bar) <i>(Effective control range is 10%-100% of full scale)</i>
Pressure Accuracy:	\pm 1.5% Full Scale max
Response:	<15 ms <i>(Response time to target pressure is output volume dependent)</i>
Linearity:	< \pm 1.5% Full Scale

VSO is a registered trademark of Parker Hannifin Corporation.



VSO®-LP Long Performance Miniature Pressure Controllers

How Flow Effects Pressure Control

This flow curve illustrates the flow capability of the VSO®-LP pressure controller.

Pressure control using a constant flow approach requires the system to manage pressure drops across a variable orifice and a fixed orifice (see below).

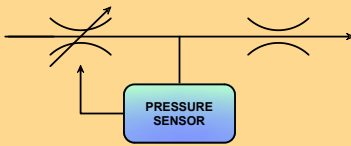

Choosing the Right Product

In many cases, the fixed orifice is the cumulative restriction of the application system consuming gas in parallel with the venting orifice. That fixed restriction and the inlet supply pressure level are key factors when determining if the VSO®-LP is the right solution for your application.

If the orifice is too small, it may fail to generate enough flow to drop the required pressure across the fixed orifice. If the orifice is too large, the Pressure Controller can become unstable. When considering orifice size please remember that the effective control range is 10%-100% of full scale.

The VSO®-LP makes use of a secondary pressure release valve. This valve is an "off and on" valve and is used to depressurize the controlled pressure upon a pressure reduction requested through the lowering of the set point. This valve does not effect the pressure control while the unit is in the stable state of pressure regulation.

EXAMPLE:

Please refer to flow chart labeled 0.030" (0.75mm) orifice. If your application requires 40 PSIG of pressure at 5 SLPM of flow, the 0.030" orifice VSO-LP would be the correct device for your application.

This graph shows that the 0.030" orifice, 100 PSIG unit will flow up to 7.5 SLPM at 40 PSIG making it the right choice for your application.

VSO®-LP Flow Capability Sizing Charts

Typical Flow vs Pressure @ 25°C

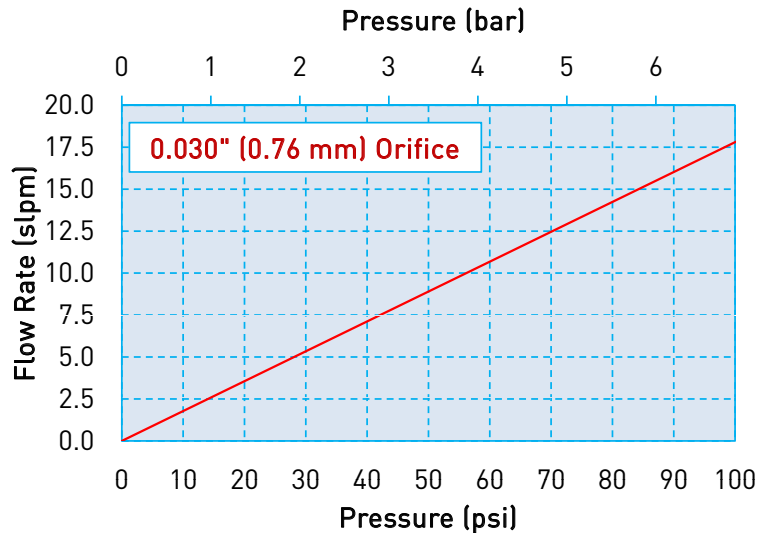
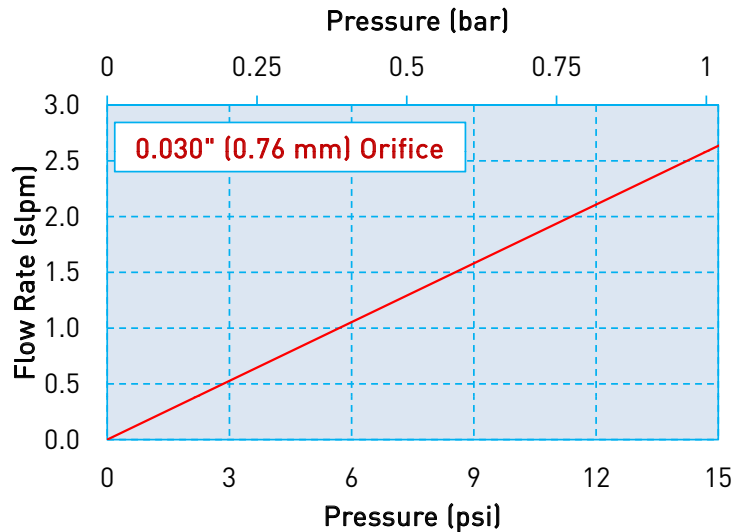

VSO®-LP Long Performance Miniature Pressure Controllers

Mechanical Integration

Dimensions

VSO-LP Basic Dimensions

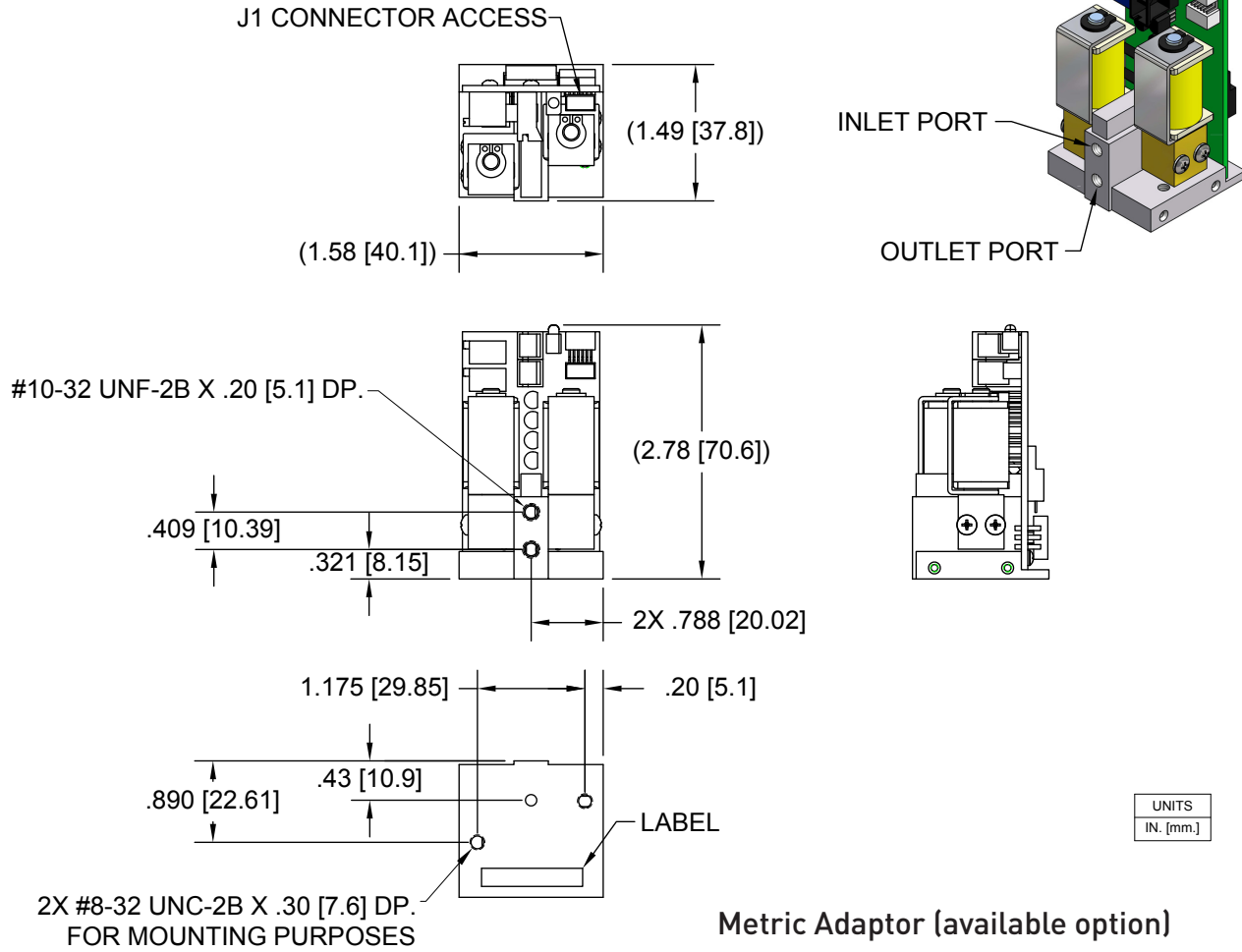

Electrical Interface

Molex, 874380642 Connector (included)	
Signal	Conn. Pin No. Color
Main Power, 24 VDC	1 Yellow
Input Control Signal, 0-5 VDC	2 Green
Monitor Signal Output, 0-5 VDC	3 Red
System Ground	4 Black
N/A	5 No Connection
N/A	6 No Connection

Metric Adaptor (available option)

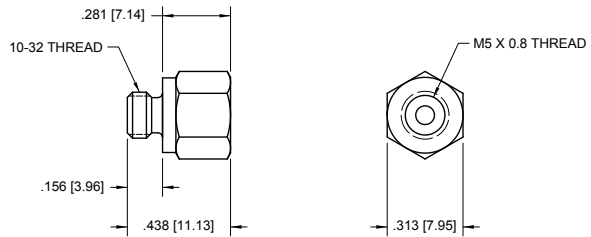

Molex #874380642 to flying lead Plug-in Cable (included)

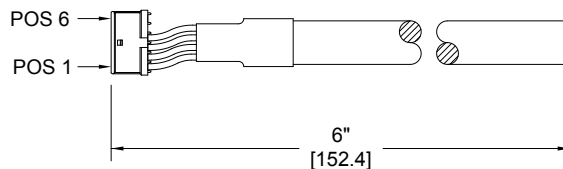

VSO®-LP Long Performance Miniature Pressure Controllers

Installation Guide

The VSO®-LP is a dynamic pressure controller that uses proportional valve technology to supply an accurate and stable pressure source for a variety of application requirements. It also incorporates a secondary pressure release valve that automatically reduces the pressure rapidly by venting it to atmosphere as required. Installation of this device requires the completion of a few easy steps.

They are as follows:

- Ensure that the gas is non corrosive, clean and dry.
- Connect the gas supply to the Inlet (Top) Port on the VSO®-LP.
- Connect a line requiring the controlled pressure to the Outlet (Bottom) Port on the VSO®-LP.
- Pneumatic ports are 10-32 UNF-2B Female. Metric Adapter option is available.
- LED indicator lights when unit is in control.
- The EPC effective control range is 10%-100% of full scale.
- Electrical connections are made through connection at the top of the unit.

They are as follows:

Molex, 874380642 Connector (included)	
Signal	Conn. Pin No. Color
Main Power, 24 VDC	1 Yellow
Input Control Signal, 0-5 VDC	2 Green
Monitor Signal Output, 0-5 VDC	3 Red
System Ground	4 Black
N/A	5 No Connection
N/A	6 No Connection

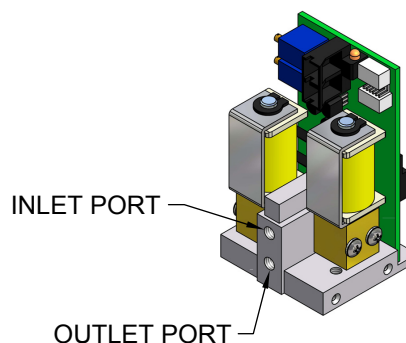

Key Things to Remember:

The pressure controller requires downstream restriction to build pressure.

- The VSO-LP is a venting controller. The venting controller is configured with an internal vent orifice that is roughly 40% of the controller's variable orifice size. This configuration of controller can supply pressure to an application with a effective downstream restriction that represents 30% of the controller orifice size down to a completely restricted application.

For example:

A vented controller with an orifice size of 0.030" should have 0.000" to 0.010" effective downstream restriction.

Note: The secondary depressurization valve does not effect the VSO®-LP's ability to control pressure and is not taken into account while estimating the application flow requirements versus the unit's ability to supply flow. On a venting unit, it works in parallel with the venting orifice.

VSO®-LP Long Performance Miniature Pressure Controllers

Configuration

Pressure Controller with Internal Vent

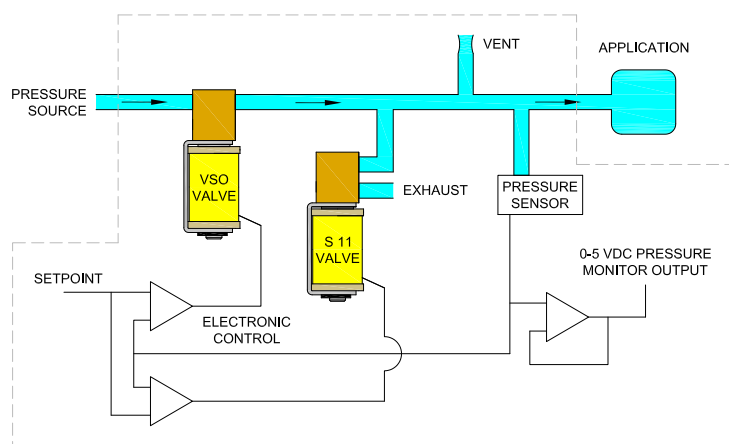

With Internal Vent.

A vent is required when the application does not consume any gas. For example, pressurizing a piloted regulator.

Ordering Information

Part Number	990-005403-015	990-005403-100
Series	VSO-LP	VSO-LP
Configuration	Internal Vent	Internal Vent
Effective Orifice	0.030" (0.76 mm)	0.030" (0.76 mm)
Relief Valve Orifice	0.030" (0.76 mm)	0.030" (0.76 mm)
Power	24 VDC	24 VDC
Control Voltage	0-5 VDC	0-5 VDC
Pressure Range	0-15 psig	0-100 psig

Accessories	
Part Number	190-008246-001
Configuration	10-32 Male to M5 x 0.8 mm Female Adaptor w/O-ring
Wetted Materials	FKM & Brass



NOTE: In order to provide the best possible solution for your application, please provide the following requirements when contacting Applications Engineering:

- Media, Inlet & Outlet Pressures
- Minimum Required Flow Rate
- System Supply Voltage
- Media
- Ambient Temperature Range

Please click on the Order On-line button (or go to www.parker.com/precisionfluidics/vsolp) to configure your VSO-LP Miniature Electronic Pressure Controller. For more detailed information, visit us on the Web, or call and refer to Performance Spec. #790-002272-001 and Drawing #890-003186-002.

PPF-EPC-002/US July 2016

For more information call +1 603 595 1500 or email ppfinfo@parker.com
Visit www.parker.com/precisionfluidics



NOTES
