

CONTENTS

SAFETY INSTRUCTIONS	4
1. - GENERAL		6
2. - GENERAL CHARACTERISTICS		7
2.1 - Electrical Characteristics		7
2.2 - Mechanical Characteristics		8
2.3 - MIMIC DIAGRAM		8
3. - DIMENSIONS		10
4. - ELECTRICAL CONNECTIONS		12
4.1 - General Wiring Requirements		12
4.1.1 - Appliance handling		12
4.1.2 - Electromagnetic compatibility		12
4.2 - Wiring Diagram		13
4.3 - Front Panel		16
4.4 - X1 Terminal Connection		17
4.5 - X2 Terminal Connection		19
4.6 - X3 Terminal Connection		19
4.7 - X4 Terminal Connection		19
4.8 - Accessories		20
4.8.1 - Input mains filter:		20
4.8.2 - Transformers		20
4.8.3 - Inductors		20
5. - EXTERNAL SETTING DISPLAY		24
5.1 - Displays :		24
5.2 - Front Panel Settings:		24
6. - ADAPTATIONS		25
6.1 - Strap and Switch Positions		25
6.2 - Definitions		26
6.3 - Regulation Card		26
6.4 - Nominal Speed Adjustment (R105)		27
6.5 - Pulse current adjustment (R113)		28

6.5.1	- Pulse current I _{lim} modification via R113	28
6.5.2	- Current limitation by external resistance or external voltage :	28
6.6	- I = f(t) Adjustment (R103 - R109)	29
6.6.1	- Trigger limit I = f(t) R103	29
6.6.2	- I _f (t) trigger delay (R109)	29
6.6.3	- Calculation of maximum duration of pulse regime	30
6.7	- Speed Information Adaptation (R104)	33
6.8	- Adaptation to the current limitation curve speed function I_f(N)_{_(R131-R132)}	33
6.9	- Adaptation to the U-RI function (R133-R134)	34
6.10	- Adaptation to max.N (R135)	35
6.11	- Adaptation to motor inductance (R136)	35
6.12	- Adaptation of dc voltage (RB)	36
6.12.1	- Effect of voltage adaptation on operating limits	36
6.12.2	- Effect of voltage adaptation on recovery	36
7.	- SPEED LOOP	37
7.1	- Speed loop rapid adjustment	37
7.2	- Complete speed loop adjustment	38
7.3	- DIAGNOSTIC HELP	40
8.	- COMMISSIONING FAULTS	41
9.	- RAMP OPTION	43
10.	- BATTERY OPERATED RTS 40/80 FEATURES	44
10.1	- Electrical Characteristics	44
10.2	- X3 Terminal Connection	44
10.3	- Adaptation to U-RI Function (R133, R134)	44
10.4	- Adaptation to dc voltage (RB)	44
11.	- ADDITIONAL RESISTOR TYPE RTS 40/80 SPECIAL FEATURES	48
11.1	- Description	48
11.2	- Dimensions	48
11.3	- Front Panel	50
11.4	- Wiring Diagram	51

Characteristics and dimensions subject to change without notice.

YOUR LOCAL CORRESPONDENT



SSD Parvex SAS

8 Avenue du Lac / B.P 249 / F-21007 Dijon Cedex
Tél. : +33 (0)3 80 42 41 40 / Fax : +33 (0)3 80 42 41 23
www.SSDdrives.com

SAFETY

Servodrives present two main types of hazard :

- Electrical hazard

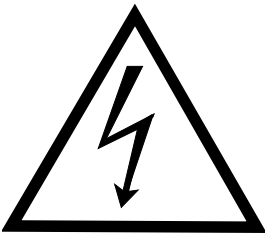

Servoamplifiers may contain non-insulated live AC or DC components. Users are advised to guard against access to live parts before installing the equipment.

Even after the electrical panel is de-energized, voltages may be present for more than a minute, until the power capacitors have had time to discharge.

Specific features of the installation need to be studied to prevent any accidental contact with live components :

- Connector lug protection ;
- Correctly fitted protection and earthing features ;
- Workplace insulation (enclosure insulation humidity, etc.).

General recommendations :

- Check the bonding circuit;
- Lock the electrical cabinets;
- Use standardised equipment.



- Mechanical hazard

Servomotors can accelerate in milliseconds. Moving parts must be screened off to prevent operators coming into contact with them. The working procedure must allow the operator to keep well clear of the danger area.

All assembly and commissioning work must be done by **qualified** personnel who are familiar with the safety regulations (e.g. VDE 0105 or accreditation C18510).

Upon delivery

All servoamplifiers are thoroughly inspected during manufacture and tested at length before shipment.

- Unpack the servoamplifier carefully and check it is in good condition.
- Also check that data on the manufacturer's plate comries with data on the order acknowledgement.

If equipment has been damaged during transport, the addressee must file a complaint with the carrier by recorded delivery mail within 24 hours.

Caution :

The packaging may contain essential documents or accessories, in particular :

- User Manual,
- Connectors.

Storage

Until installed, the servoamplifier must be stored in a dry place safe from sudden temperature changes so condensation cannot form.

Special instructions for setting up the equipment

	CAUTION
	<p>For this equipment to work correctly and safely it must be transported, stored, installed and assembled in accordance with this manual and must receive thorough care and attention..</p> <p>Failure to comply with these safety instructions may lead to serious injury or damage.</p> <p>The cards contain components that are sensitive to electrostatic discharges. Before touching a card you must get rid of the static electricity on your body. The simplest way to do this is to touch a conductive object that is connected to earth (e.g. bare metal parts of equipment cabinets or earth pins of plugs).</p>

1. - GENERAL

The RTS 40/80 servoamplifier is a four-quadrant speed controller designed to drive medium power dc motors (up to 6500 W mechanical power). The output stage features IGBT type technology and is galvanically isolated with a Hall effect current sensor. External inductors are not required (except for AXEM motors) because of high frequency, inaudible (17 kHz) PWM chopping. It is a single-axis controller (wall-mounted) with front panel connections.

Functions :

- tachometer or U-RI speed regulation
- current control
- current reduction with speed
- current reduction with temperature
- external current reduction
- zero speed adjustment
- zero torque adjustment
- Fault clearance
- analogue speed or torque information
- Controller status on relay contact
- ± 15 V available
- recovery limitation
- customisation card
- optional ramp card (internally mounted)
- clockwise and counter-clockwise stop feature

2. - GENERAL CHARACTERISTICS

2.1 - Electrical Characteristics

Power supply: three-phase between 75 and 165 V ac maximum (For use of standard transformers - 85, 100, 110, 135 & 150 V ac $\pm 10\%$)

Output voltage: 200 V dc with 150 V ac power supply

Output current: 40 A nominal
80 A - 2 sec pulse (starting from $I=0$)

Recovery*: Mean power max. 525 W max
Pulse power max. 13 000 W
Max. cycle 4%
Max. uninterrupted duration 2 sec

*(*servoamplifier with 150 V ac supply)*

Minimum inductance: 0.4 mH for a form factor of less than 1.002
(compulsory for AXEM motors)

Total dissipation: 300 W excluding recovery

Chopping frequency: 17kHz

Power stage galvanically isolated

Speed range: - tachometer regulation 1/10 000
- U-RI regulation 1/10 or U-RI / 100 with RR6606C
and RD6606B or 6607B

Static precision of typical speed for zero load at nominal current:

- tachometer regulation:	$N_{max} - N_{max}/100$:	$\pm 0.5\%$
	$N_{max}/100 - N_{max}/1000$:	$\pm 1.5\%$
	$N_{max}/1000 - N_{max}/10\ 000$:	$\pm 10\%$
- U-RI regulation:	$\pm 20\%$		

Speed bandwidth (depending on drive line): up to 150 Hz

Current regulation precision: $\pm 2\%$ of nominal current at 25° C

Current loop linearity: $\pm 1\%$ of nominal current at 25° C

2.2 - Mechanical Characteristics

Storage temperature: -20° to +70° C
operating temperature: 0° to +40° C
from 40° to 60° C: -3.5% of nominal current per degree

Maximum altitude: 1000 m
above: -1% of nominal current per 100 m

Protection Index: IP 20

2.3 - MIMIC DIAGRAM

3. - DIMENSIONS

See the following page, drawing number - FELX 305008

4. - ELECTRICAL CONNECTIONS

4.1 - General Wiring Requirements

4.1.1 - Appliance handling

See the safety instructions given at the beginning of this manual. In particular, wait for all the front panel LEDs to go off completely before doing any work on the servo-amplifier or servomotor.

4.1.2 - Electromagnetic compatibility

EARTHING

- Comply with all local safety regulations concerning earthing.
- Utilize a metal surface as an earth reference plane (e.g. cabinet wall or assembly grid). This conducting surface is termed the potential reference plate. All the equipment of an electrical drive system is connected up to this potential reference plate by a low impedance (or short distance) link. Ensure the connections provide good electrical conduction by scraping off any surface paint and using fan washers. The drive will then be earthed via a low impedance link between the potential reference plate and the earth screw at the back of the RTS. If this link exceeds 30 cm, a flat braid should be used instead of a conventional lead.

CONNECTIONS

- Do not run low-level cables (inputs/outputs, NC or PC links) alongside what are termed power cables (power supply or motor). Do not run the power supply cable and the motor cables alongside one another otherwise mains filter attenuation will be lost. These cables should be spaced at least 10 cm apart and should never cross, or only at right-angles.
- All low-level signals will be shielded with the shielding connected at both ends.
- The motor cables are limited to the minimum functional length. The yellow and green motor cable lead must be connected to the box or front panel terminal block with the shortest possible link.
- This usually means shielded motor cable is not required. Chokes may also be inserted into the motor phase leads.

MAINS FILTERING

The mains filter must be mounted as close as possible to the potential reference between the mains and the TRS power supply. (p.20 FR 03036).

Avoid running cables together, ahead of and after the filter.

Filters sometimes have high leakage currents. In this case, comply with the standard connection diagrams when fitting them.

OTHER MEASURES

Self-inducting components must be protected against interference: brakes, contactor or relay coils, fans, electro-magnets, etc.

4.2 - Wiring Diagram

See the following page, drawing number - FELX 305062 and FELX 305823

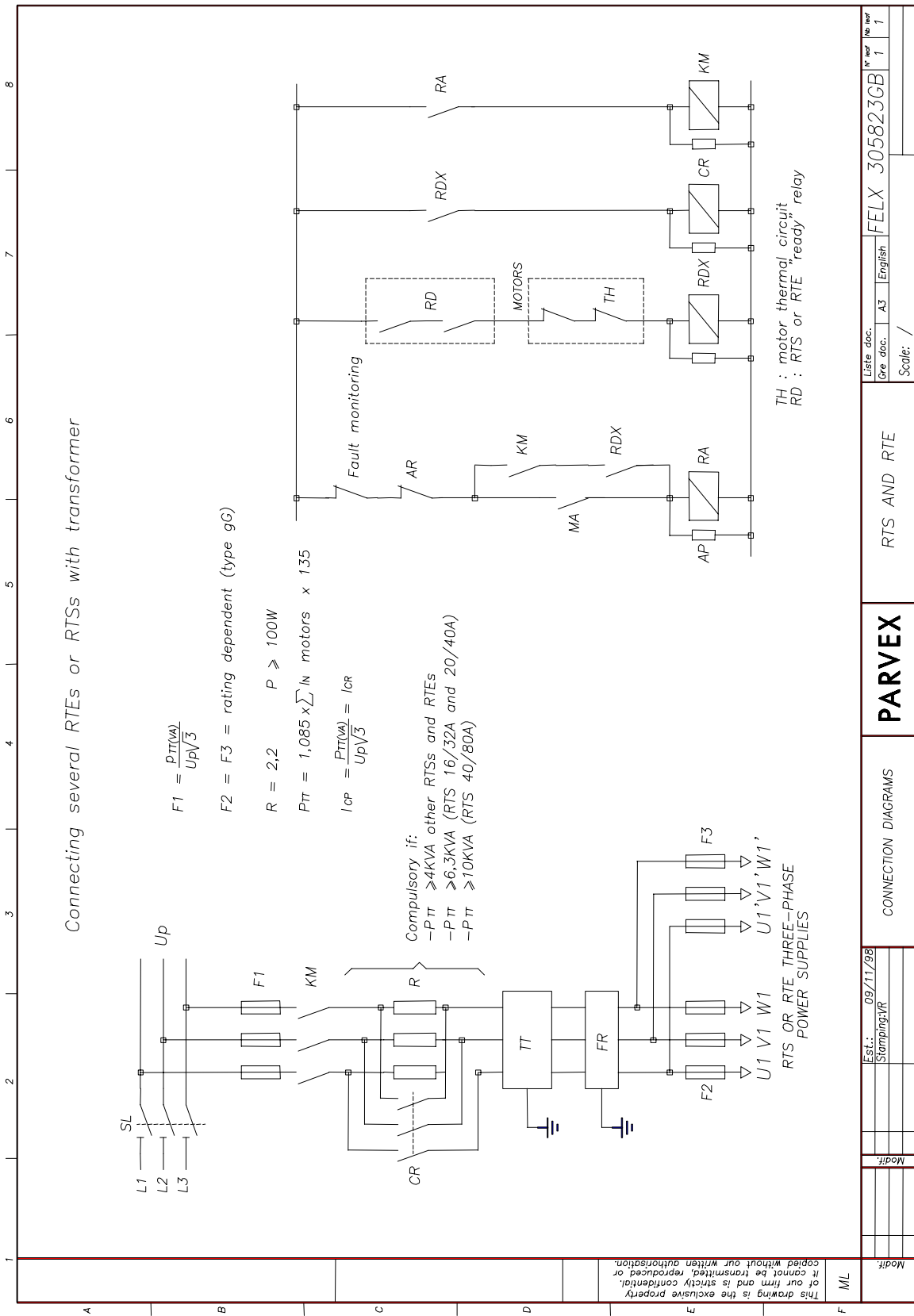

1
2
3
4
5
6
7
8



Connecting several RTEs or RTSs with transformer

ML	Modif:	Est.: 09/11/99	Stamping:VR	CONNECTION DIAGRAMS	PARVEX	RTS AND RTE	Liste doc. / Gra doc. / A3 English No. par / 1 FELX 305823GB	Scale: /
----	--------	----------------	-------------	---------------------	---------------	-------------	---	----------

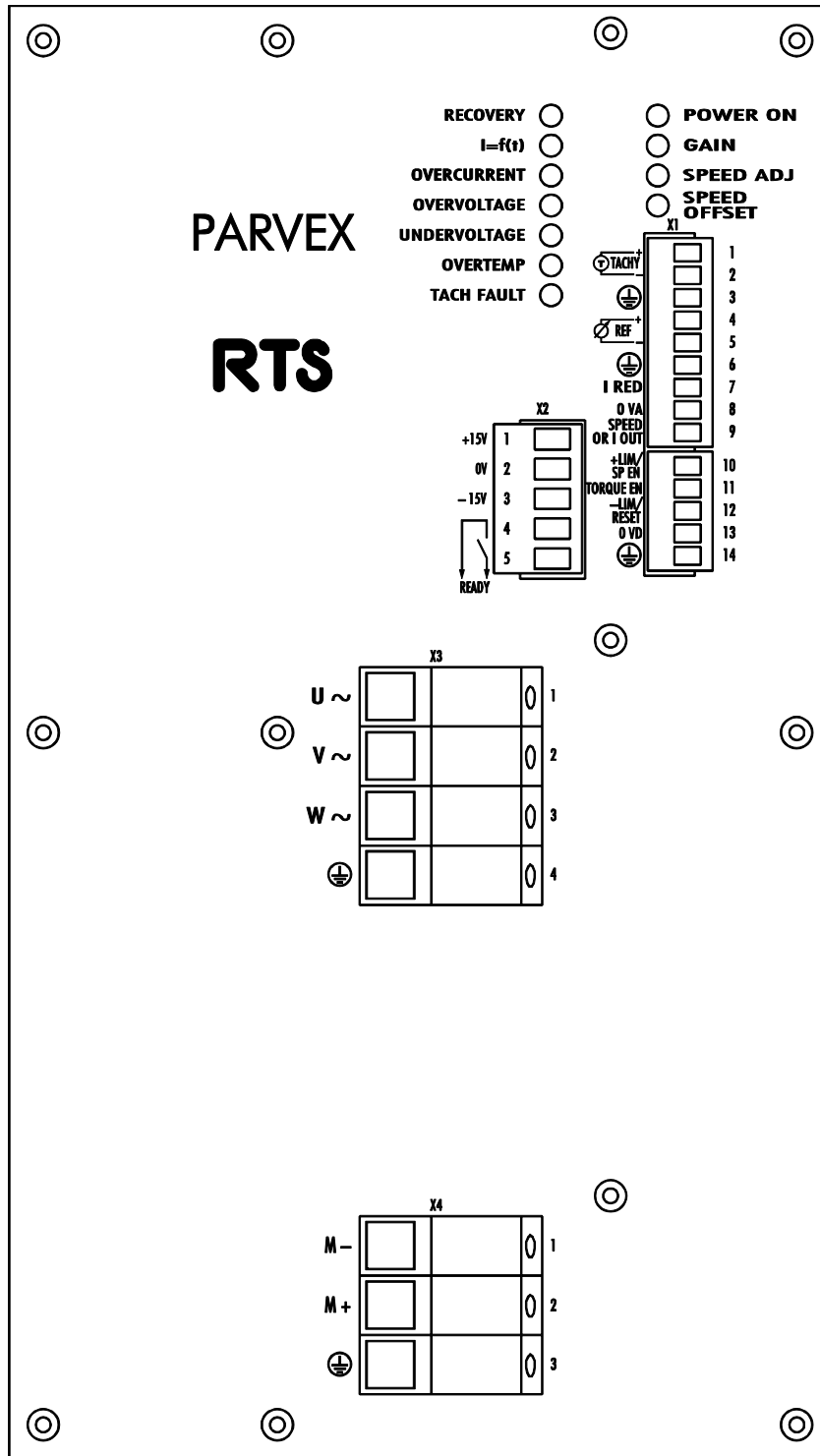
4.3 - Front Panel





4.4 - X1 Terminal Connection

N°	TERMINAL	Permissible cable cross-section: 1.5 mm ² multistrand Use screened cables	
	Designation	The screened connected to earth terminals 	
1	TACH +	Input	Tacho differential inputs. Use shielded cable with shielding connected to terminal 3.
2	TACH -	Input	Input voltage must not exceed 100 V.
3		-	Tachometric cable shielding. Do not connect shielding at tacho end.
4	REF +	Input	Speed or current differential reference depending on position of selector switch S1.
5	REF -	Input	± 10 V corresponds to rated motor speed at speed reference. Use shielded cable with shielding connected to terminal 6.
6		-	Shielding, to be connected at numerical control end also.
7	IRED	Input	Analogue current reduction. This reduction can be driven either by voltage or by an external resistor by connecting it to 0VA (terminal 8).

External resistor value:

Percentage of maximum servoamplifier current	10	20	30	40	50	60	70	80	90
Resistance R in kΩ	1.21	4.75	8.25	15	18.2	27.4	33.2	47.5	56.2

N°	TERMINAL	Permissible cable cross-section: 1.5 mm ² multistrand Use screened cables	
	Designation	The screened connected to earth terminals 	
8	0 VA	-	Internally connected to mechanical earth
9	SPEED OR I OUT	Output	Signal providing speed or current image depending on selector switch S2 position. ± 10 V corresponds to the maximum the value. Typical applications: synchronisation of multiple conveyors, master-slave mode, cutting tool wear surveillance
10	SPEED EN./ +LIM (Y3 in position 2-3 on RR6606B)	Input	SPEED ENABLE. For connection to 0 V (terminal 13). Connected to 0 V (terminal 13) this input enables only counter-clockwise movement viewed from shaft end (corresponds to negative speed reference) Typical application: Clockwise stroke limit
11	TORQUE EN.	Input	TORQUE ENABLE. For connection to 0 V (terminal 13) to enable current to servomotor. If the terminal is not connected, the servomotor turns freely. When the servomotor is fitted with a holding brake, this input control must be synchronised with the brake control.
12	RESET/ -LIM (Y3 in position 2-3 on RR6606B)	Input	Reset. By connecting RESET to terminal 13 the fault memory is cleared and the controller is ready again, if the fault has disappeared. Switching the servoamplifier off and then back on has the same effect as resetting. Connected to 0 V (terminal 13) this input enables only clockwise movement viewed from shaft end (corresponds to positive speed reference) Typical application: Counter-clockwise stroke limit
13	OVD	-	0V logic, for connection to terminals 10 and 11.
14		-	Logic link cable screening (terminals 10 and 11).

4.5 - X2 Terminal Connection

N°	TERMINAL	Permissible cable cross-section: 1.5 mm ² multistrand	
	Designation		
X2/1	+ 15 V	Output	± 15 V power supply 25 mA ± 5% available for external applications Output via contact of sum of faults. Contact opens if fault occurs and if power supply absent Permissible current: 0.5 A Permissible voltage: 230 V
X2/2	0 V	-	
X2/3	- 15 V	Output	
X2/4	READY	Output	
X2/5	READY	Output	

4.6 - X3 Terminal Connection

N°	TERMINAL	Permissible cable cross-section: 1.5 mm ²	
	Designation		
X3/1	U ~	Input	U phase of three-phase power supply V Phase. W Phase. Earth. For connection to the earthing bar of the appliance cabinet. With cable cross-section: 2.5 mm² min.
X3/2	V ~	Input	
X3/3	W ~	Input	
X3/4		-	

4.7 - X4 Terminal Connection

N°	TERMINAL	Permissible cable cross-section: 1.5 mm ²	
	Designation		
X4/1	M -	Output	Connection Servomotor. Earth. For connection to the motor frame.
X4/2	M +	Output	
X4/3		-	

4.8 - Accessories

4.8.1 - Input mains filter:

Dimensions as in drawings FELX 304967 (see following page).

4.8.2 - Transformers

Dimensions as in drawings FELX 302570 (see following page).

4.8.3 - Inductors

These are compulsory with AXEM motors and motors whose winding inductance is less than the operating minimum (recommended inductance: SF 02024).

Dimensions as in drawings FELX 302804 (see following page).

Position	Text	Identification number	Weight
	MANS FILTER 3 ph OUTLINE DIMENSIONS	FELX 304967GB P.	

* permissible section

U_{in} : 440 Vac 50/60Hz
T_a : 40°C
Norm : EN 133200

Pos.	Standard Nr	Current	Dimensions		* Section	Weight
			A	B		
1	FR 03016	16A	241	201	4mm ²	3Kg
2	FR 03036	36A	251	201	10mm ²	3Kg
3	FR 03064	64A	308	231	25mm ²	4Kg

Standard Nr	Max. leakage current (50/60Hz) in mA	
	three-phase operation	unbalanced operation (start-up)
FR 03016	10	30
FR 03036	3	200
FR 03064	3	170

Service	Drawing	26/06/96	LR	Stamping	ML
A	AME97016 - 22/01/97 - LR		D	AME98056 - 12/05/98 - VR	Repeating
B	AME97162 - 20/11/97 - VR		E	AME98175 - 09/11/98 - VR	Separate nomenclature of liba diff.
C	AME98035 - 11/03/98 - VR				Separate nomenclature of same Nbr
PARVEX					
MANS FILTER 3 ph					
OUTLINE DIMENSIONS					
FELX 304967GB					

Position	Text	Identification number	Weight
	Trans. 3ph RTS/RTE/SBS DIMENSIONS	FELX 302570GB P..	

PRIMARY

S3	E3	S2	E2	S1	E1
----	----	----	----	----	----

SECONDARY

-5%	-5%	135V	135V	+5%	+5%	+5%	+5%	N
-----	-----	------	------	-----	-----	-----	-----	---

ALIMENTATION
DELTA COUPLING
230V

STAR COUPLING
400V

PRIMARY : 230V/400V STAR-DELTA
 SECONDARY : 135V STAR (PRISE A +/- 5%)
 FREQUENCY : 50-60 Hz
 AMBIANT TEMPERATURE : MAX 40°C
 INSULATION : CLASSE F
 STANDARD : IEC 76

Pos	Standard Number	Power	Dimensions overall			Fixing	Weight
			A	B	H	axb	
1	TT 11115	1KVA	225	125	155	180x90	14Kg
2	TT 11116	1,6KVA	225	155	155	180x125	17Kg
3	TT 11117	2,5KVA	295	130	205	200x100	27Kg
4	TT 11118	4KVA	295	160	235	200x130	40Kg
5	TT 11119	6,3KVA	360	210	330	240x115	48Kg
6	TT 11120	10KVA	360	250	360	240x130	62Kg
7	TT 11149	0,63KVA	190	110	135	150x80	8,5Kg

DIMENSIONS IN mm

Service	Drawing	12/11/89	FM	Stamping	Order of execution	ML
	G AME8025 - 18/02/98 - VR				Replacing	
Modifications						
Scale /						
Separate nomenclature of Nbs dif.						
Separate nomenclature of same Nbr						
Family						
SIZE A3						
LEAF N° 1 Nb 1						
Trans. 3ph RTS/RTE/SBS					FELX 302570GB	
DIMENSIONS						

This drawing is the exclusive property of our firm and is strictly confidential. It cannot be transmitted, reproduced or copied without our written authorisation.

Position	Text	Identification number	Weight
	CHOKE FOR RTS/RTE DIMENSIONS	FELX 302804GB P..	

Pos	Standard Number	Ct nom.	Choke nom.	Dimensions			Fixing a x b	Capas terminal	Weight
				A	B	H			
1	SF 02021	8,5A	5mH	97	110	/	90	79x85	4mm ² 2,8kg
2	SF 02022	16A	2,5mH	126	105	/	115	105x76	4mm ² 4,2kg
3	SF 02023	25A	1,5mH	126	120	/	135	105x93	10mm ² 5,9kg
4	SF 02024	40A	1mH	126	150	180	110	105x125	# 8,8kg

Dimensions in mm

#: Output via busbar cross-section 15X3, ø6mm bore

- For pos. 1-2-3 :
 $L_{2IN} \geq 0,9L_{IN} \text{ à } 5\text{kHz}$
 and $L_{2IN} > 0,8L_{IN} \text{ à } 17\text{kHz}$

- For pos. 4 :
 $L_{2IN} \geq 0,9L_{IN} \text{ à } 5\text{kHz}$

Service	Drawing	23/08/90	FM	Stamping	ML		
A	AME94089	- 22/08/94	- JP	D	AME96029	- 29/02/96	- LR
B	AME95068	- 21/07/95	- FA				
C	AME95117	- 09/11/95	- JP				

This drawing is the exclusive property of our firm and is strictly confidential. It cannot be transmitted, reproduced or copied without our written authorisation.

Order of execution	Replacing	Scale	Separate nomenclature of the aff.	Separate nomenclature of same Nbr	Family
		/			A3
PARVEX			CHOKE FOR RTS/RTE		
DIMENSIONS			FELX 302804GB		

5. - EXTERNAL SETTING DISPLAY

5.1 - Displays :

POWER ON	off	: no power supply to drive
	On	: drive OK
	Flashing	: drive fault
RECOVERY	recovery control	

Controller faults are distinguished and displayed by miniature LED strips on the front panel :

I=F(t)	excessive mean motor current
OVERCURRENT	motor short circuit or current too high
OVERVOLTAGE	bus voltage too high
UNDERVOLTAGE	bus voltage too low
OVERTEMP	excessive temperature
TACH. FAULT	tachometer cut-out or reversal, overspeed

5.2 - Front Panel Settings:

GAIN	: speed loop gain adjustment
SPEED ADJ	: fine adjustment of maximum speed
SPEED OFFSET	: fine adjustment of speed offset

For current control operation, capacitor C101 must be removed to give the broadest bandwidth with resistor R136 adapted to load inductance.

6. - ADAPTATIONS

ATTENTION

As the servoamplifiers settings are done at the factory, the information on this page is not essential.

6.1 - Strap and Switch Positions

- Control mode: S1 switch

	S1
speed control	1
current control	0

- Current or speed (N or I) information output (solder tag or S2 switch)

	S2
current information	1
speed information	0

±10 V output available at X1/9.
 10 V = I_{max}
 10V = nominal speed

- Tachometer or U-RI regulation (solder tag or S3 switch)

	S3
tachometer	1
U-RI	0

- Selection of +LIM, -LIM function

The +LIM, -LIM function is selected with strap Y3 (solder tag on RR6606B or RR6606C card). When the strap is in position 2-3, the SPEED ENABLE input (+LIM) (X1-10) is used to enable or disable clockwise motor rotation viewed from the shaft end. Rotation is enabled when X1-10 is connected to the 0 V (terminal 13 of X1).

Likewise, the RESET input (-LIM) (X1-12) is used to enable or disable counter-clockwise rotation of the motor. Rotation is enabled when X1-12 is connected to the 0 V (terminal 13 of X1).

N.B. Y5 and Y6 must be in the ON position.

6.2 - Definitions

Nn	=	rated speed of application for 10 V reference speed
Ilim	=	maximum pulse current of motor
I _{max}	=	maximum pulse current of servo amplifier
I _o	=	permanent motor current
K _{et}	=	speed information gradient in volts for 1000 rpm
K _e	=	back electromotive force of motor in volts per 1000 rpm
r	=	resistance of motor and its supply circuitry in ohms
L	=	inductance of motor in Henrys
U _b	=	bus voltage in volts (1.35 x V _{in} AC)
Val	=	transformer phase-phase output voltage in Volts rms

6.3 - Regulation Card

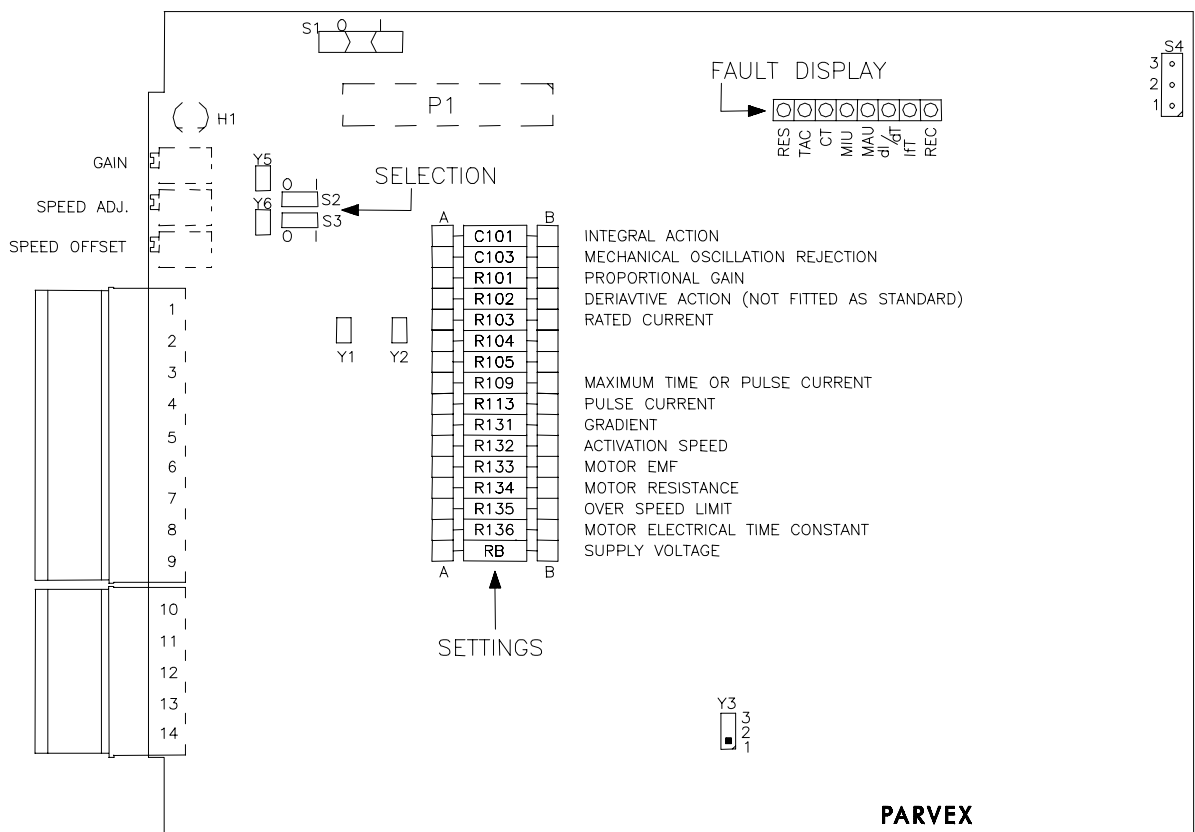

RR 6606B SELECTION

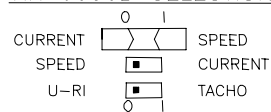

RR 6606B SELECTION

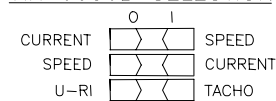

S1 : COMMAND TYPE
S2 : OUTPUT TYPE
S3 : SERVOCONTROL TYPE

6.4 - Nominal Speed Adjustment (R105)

- standardised value close to the calculated value and adjustable with potentiometer SPEED ADJUST :

$$R105 = \frac{192000}{Nn} \quad \text{in } k\Omega$$

Nn: speed for set point of 10 V in rpm

Speed Nn in rpm	R105 in kΩ
700	275
770	-----
869	221
950	-----
1055	182
1200	-----
1280	150
1400	-----
1590	121
1650	-----
1750	110
1800	-----
1920	100
2100	-----
2330	82,5
2600	-----
2820	68,1
3100	-----
3420	56,2
3700	-----
4040	47,5
4400	-----
4900	39,2
5200	-----

The equipment may be adapted for speeds lower than those shown above but this hinders servo amplifier performance with regard to drift and gain. The maximum value not to be exceeded for R105 is 4.75 MΩ.

6.5 - Pulse current adjustment (R113)

6.5.1 - Pulse current Ilim modification via R113

RTS 40/80-200	$R113 = \frac{I_{lim}}{24 - 0,3/I_{lim}}$ in kΩ
----------------------	---

$\frac{I_{lim}}{I_{max}}$ in %	10	20	30	40	50	60	70	80	90
R113 in kΩ	0,392	0,825	1,5	2,21	3,32	4,75	7,5	12,1	33,2

6.5.2 - Current limitation by external resistance or external voltage :

- by external resistance :

RTS 40/80-200 I_{elim} in amps	$R_{ext} = \frac{I_{elim}}{2,68 - \frac{I_{elim}}{47,5}}$ in kΩ
--	---

$\frac{I_{elim}}{I_{max}}$ in %	10	20	30	40	50	60	70	80	90
Rext in kΩ	3,32	6,81	10	15	22,1	27,4	39,2	47,5	56,2

- by external voltage :

linear from 0 V to 10 V, with 10 V = I_{max}

6.6 - I = f(t) Adjustment (R103 - R109)

6.6.1 - Trigger limit I = f(t) R103

R103 adjusts the triggering threshold enabled by the drive with mean current I_0 .
 I_0 is generally the rated motor current.

RTS 40/80-200 I_0 in amps	$R103 = \frac{10}{\frac{I_{max}}{I_0} - 2} \text{ in k}\Omega$
---------------------------------------	--

I_0 = rated motor current.
 I_{max} = drive pulse current (80 A)

$\frac{I_0}{I_{max/2}}$ in %	20	30	40	50	60	70	80	90
R103 in k Ω	1,5	2,21	3,32	4,99	7,5	12,1	20	43,2

6.6.2 - If(t) trigger delay (R109)

R109 modifies the time constant for triggering in If(t).

- One second to I_{lim} from $I = 0$

$\frac{I_0}{I_{lim}}$ in %	20	30	40	50	60	70	80
R109 in k Ω	2740	1210	825	562	392	274	150

- Two seconds to I_{lim} from $I = 0$

$\frac{I_0}{I_{lim}}$ in %	20	30	40	50	60	70	80
R109 in k Ω	10000	3320	1820	1210	825	562	274

Operating times of more than 2 sec can be considered provided that the R103 and R113 values determining I_0 and I_{lim} are adjusted.

Example :

R109 = 562 kΩ

$\frac{I_o}{I_{lim}}$ in %	20	30	40	50	60	70	80
t in s	0,3	0,5	0,7	1	1,4	2	3,5

R109 = 1210 kΩ

$\frac{I_o}{I_{lim}}$ in %	20	30	40	50	60	70	80
t in s	0,6	1	1,4	2	2,7	3,8	6,8

The maximum value of resistor R109 is 1.21 MΩ (2 x I_o for 2 seconds) when R103 is infinite (the trigger current in I_f(t) corresponds to the permanent current of the controller). For permanent currents lower than that of the controller, R109 may be greater than 1.21 MΩ. See the calculations based on expressions of R109.

6.6.3 - Calculation of maximum duration of pulse regime

Based on the typical operating cycle below.

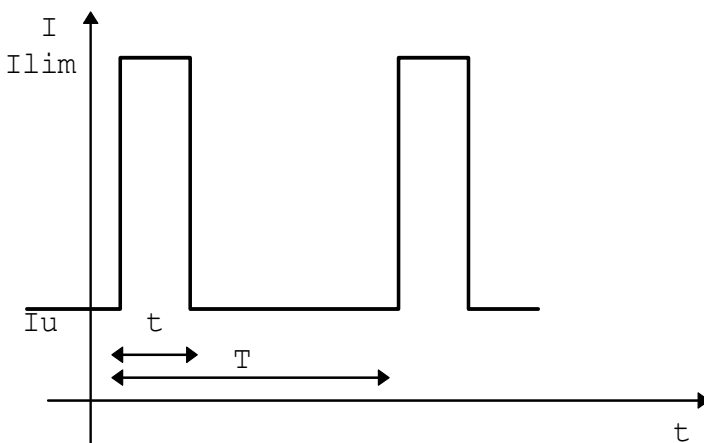

- I_{lim} : pulse current set by R113
- I_u : mean current in permanent use
- I_o : nominal current set by R103
- t : pulse current duration
- T : repetition period

From the ratio $\frac{I_u}{I_o}$ of the mean current at established speed over the permanent current set by R103, plot this value on the y-axis of the graph. Depending on the possible $\frac{I_o}{I_{lim}}$ ratio, given by R103 and R113, read on the x-axis the duration t of the pulse current that does not trigger $I_f(t)$. The minimum repetition period T can also be read from the x-axis.

These values depend on the choice of resistor R109.
The graph is plotted for $R109 = 562 \text{ k}\Omega$.

For other values of R109 apply the correction factor $\frac{R109}{562}$ to t and T readings.

Network Io: I1 (%)

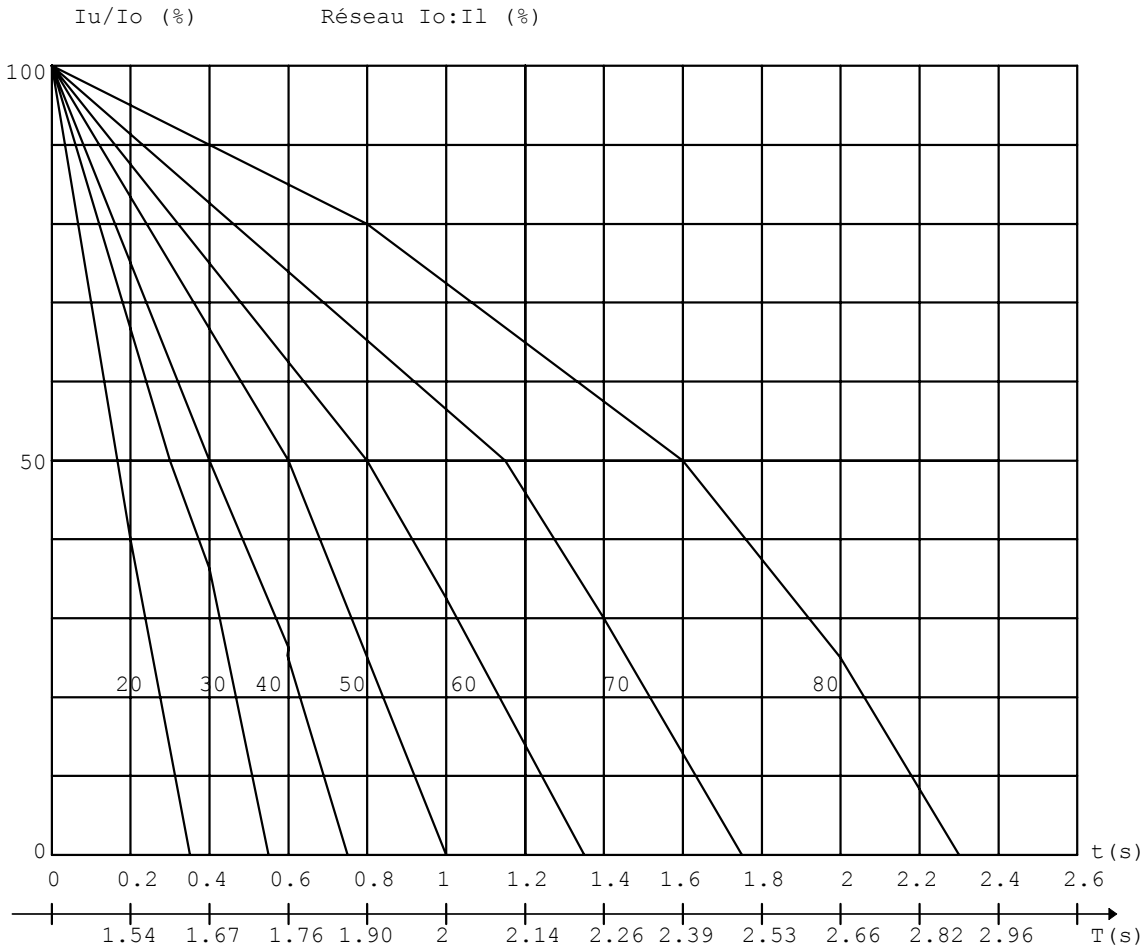

Example of a motor with a 15/30 controller whose R103 is installed for a permanent current of 10 A. It is used for

established current of 4 A ($\frac{I_u}{I_o} = \frac{4}{10} = 40\%$) with pulse current limited by R113 to:

a : $2I_o : 20$ A $\frac{I_o}{I_{lim}} = 50\%$

b : $3I_o : 30$ A $\frac{I_o}{I_{lim}} = 33\%$

The authorised duration of the pulse current will be:

a : $t \neq 0,7$ s

b : $t \neq 0,4$ s.

6.7 - Speed Information Adaptation (R104)

The R104 resistor is used to adapt the tachometer generator gradient to that of the controller (2V/1000 rpm)

$$R104 = \frac{100}{\frac{Ket}{2} - 1} \text{ in k}\Omega$$

Ket: electromotive force of the tachometer generator in volts per 1000 rpm

Ket in V/tr/mn	2	3	4	5	6	8	10	12	15	20
R104 in k Ω	∞	200	100	68	51	33	24	20	15	11

To obtain a gradient of 1V / 1000 rpm, short circuit the solder tags Y1 and Y2 with R104 = ∞ .

CAUTION : Do not exceed 100V on the tachometer input.

6.8 - Adaptation to the current limitation curve speed function If(N)_(R131-R132)

Resistor R131 is used to select the zero current point on the speed current diagram.
Resistor R132 determines the speed beyond which pulse current (selected by R113) begins to decrease linearly with speed.

When function $I = F(n)$ is not required :

R131 = 10 K
R132 = 100 K

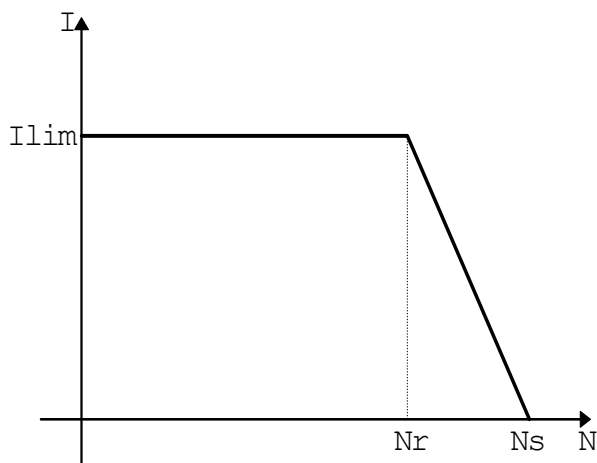

Nr : speed in thousands of rpm above which current decreases
Ns : speed in thousands of rpm at which current is zero.

$$R131 = \frac{83000}{N_s} \text{ in k}\Omega$$

Ns in tr/mn	500	1000	1500	2000	2500	3000	3500	4000
R131 in kΩ	162	82,5	56,2	39,2	33,3	27,4	22,1	20
Ns in tr/mn	4500	5000	5500	6000	6500	7000		
R131 in kΩ	18,2	16,2	15	13,7				

RTS 40/80-200 <i>Ilim</i> in amps.	$R132 = \frac{700/I_{lim} + 2220}{N_s - N_r} \text{ in k}\Omega$
--	--

R132 in KΩ	$\frac{I_{lim}}{I_{max}}$ in %					
	Ns - Nr	20	40	60	80	100
500		27,4	47,5	100	82,5	121
1000		12,1	22,1	33,2	47,5	56,2
1500		8,25	16,2	22,1	33,2	39,2
2000		6,81	12,1	18,2	22,1	27,4
2500		5,62	10	15	18,2	22,1
3000		4,75	6,82	10	15	18,2
3500		3,32	6,82	10	13,7	16,2
4000		3,32	5,62	8,25	12,1	15

6.9 - Adaptation to the U-RI function (R133-R134)

This adaptation is necessary even when operating with tachometer generation to supervise tachometer failure.

R133 is used to adjust the gain depending on the motor back emf :

For standard power supply transformers:

$$R133 \text{ in k}\Omega = \frac{4U_b}{K_e} \text{ or } \frac{38K_b}{K_e} \text{ (with RD6606B or RD6607B)}$$

RTS 40/80-200	$R133 = \frac{760}{K_e} \text{ in k}\Omega$
----------------------	---

U_b : controller bus dc voltage in volts

K_e : motor emf in volts / 1000 rpm

K_b : bus voltage reduction ratio

(20 for RD6606B)

(7.4 for RD6607B)

R134 is used to adapt the motor resistor to its power supply circuit (brushes - cables)

$$R134 \text{ in } k\Omega = \frac{15000 \times r}{U_b} \text{ or } \frac{1500r}{K_b} \text{ (with RD6606B or RD6607B)}$$

U_b : controller bus dc voltage in volts

r : motor and supply circuit resistance in ohms

For standard power supply transformers ($U_b = 190 \text{ V}$):

RTS 40/80-200	$R134 = 75 r \text{ in } k\Omega$
----------------------	-----------------------------------

6.10 - Adaptation to max.N (R135)

Resistor R135 determines the tripping limit of maximum speed for tachometric servo control and U-RI operation.

$$R135 \text{ in } k\Omega = \frac{10Nn}{7500 - Nn}$$

Nn : speed for 10 V set point in rpm

Nn in tr/mn	1000	1500	2000	2500	3000	3500
R135 in kΩ	1,5	2,74	3,92	4,75	6,81	8,25
Nn in tr/mn	4000	4500	5000	5500	6000	
R135 in kΩ	12,1	15	22,1	27,4	39,2	

6.11 - Adaptation to motor inductance (R136)

Resistor R136 adapts the current loop gain to the load inductance.

$$R136 \text{ in } k\Omega = \frac{2 \cdot 10^4 L}{U_b}$$

U_b : controller bus dc voltage in volts

L : motor inductance and any additional inductance in mH

Resistor R136 adapts current loop gain to load inductance. When selecting R136 take the closest value in the following range and its multiples :

10 - 12 - 15 - 18 - 22 - 27 - 33 - 39 - 47 - 56 - 68 - 75 - 82 - 100

6.12 - Adaptation of dc voltage (RB)

Resistor RB is used to adapt limit values : MAX U, MIN U, tripping of supply voltage recovery.

RTS 40/80-200	$RB = \frac{100}{\frac{150}{Val} - 1}$ in kΩ
----------------------	--

Val : transformer phase-phase output voltage in Volts rms.

R136 dependent on voltage Ub must be readapted.

Resistors R133, R134 are to be re-adapted for RD6606 and RD6607 only.

POWER SUPPLY	RB
85 VAC	121kΩ
100 VAC	200kΩ
110 VAC	274kΩ
135 VAC	-
150 VAC	-

6.12.1 - Effect of voltage adaptation on operating limits

Vrms value	Ub in V	MaxU in V	MinU in V	Recovery	
				Dec in V	Rel in V
150	200	258	120	243	230
135	190	258	120	243	230
110	145	189	88	178	168
100	135	172	80	162	153
85	110	141	66	133	126

6.12.2 - Effect of voltage adaptation on recovery

Vrms value	Mean power in W	Pulse power in W
150	525	13000
140	525	13000
110	280	7000
100	230	5800
85	160	4000

7. - SPEED LOOP

7.1 - Speed loop rapid adjustment

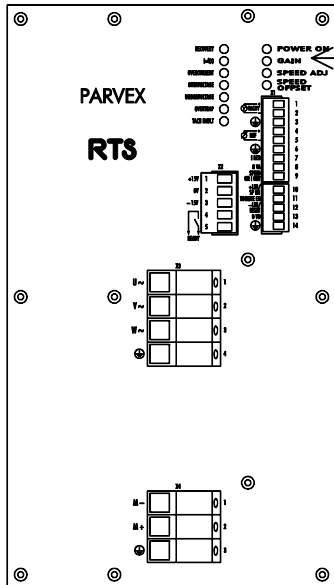

*** Offset adjustment**

Once ambient temperature is stabilised, adjust zero speed to the mid-position with the "SPEED OFFSET" potentiometer on the front panel.

*** Speed adjustment**

The "SPEED ADJUST" potentiometer produces fine calibration of speed for a given reference.

*** Gain adjustment**

By increasing gain, the servo motor becomes more rigid. Turn the "GAIN" potentiometer clockwise until the motor is unstable and vibrates.

Then turn the potentiometer back one or two turns. If there is a large load on the potentiometer, the potentiometer adjustment range may be inadequate and resistance R101 will have to be increased.

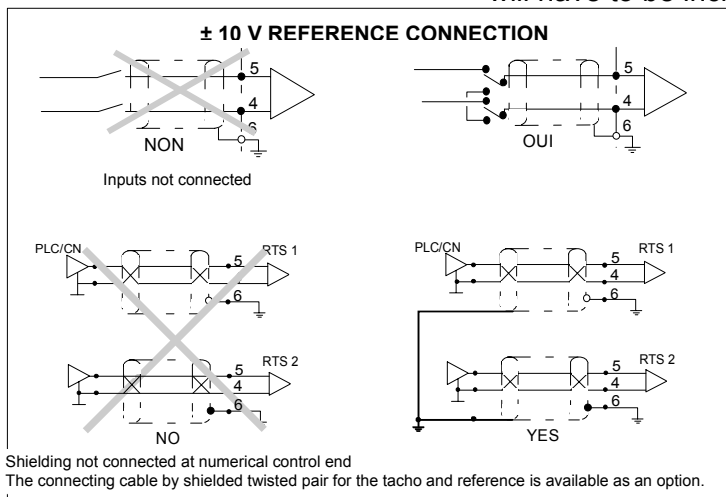

Application : Potentiometer reference

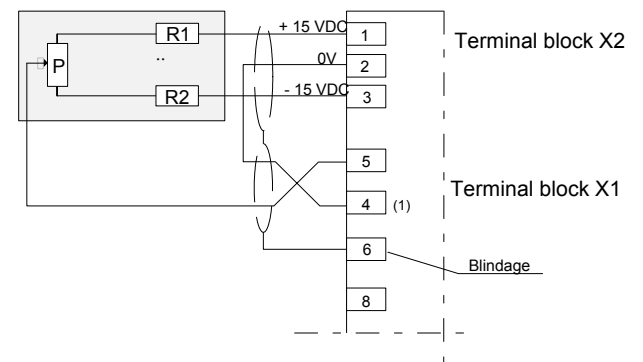

(1) Terminal 4 may be connected to terminal 8

Example : ± 10 V
 P = 10 kΩ linear potentiometer
 R1 - R2 = 1.8 kΩ, 1/2 W resistor

7.2 - Complete speed loop adjustment

Systematically applicable when J charge ≥ 10 J motors

Caution As servo amplifiers are factory set based on parameters provided by the customer, this setting does not usually require adjustment.

Before adjusting the speed loop, all the adjustable parameters must be fixed (current limits, speed scale setting, speed limits). Adjusting the speed scale setting alters loop gain and means readjustments are required.

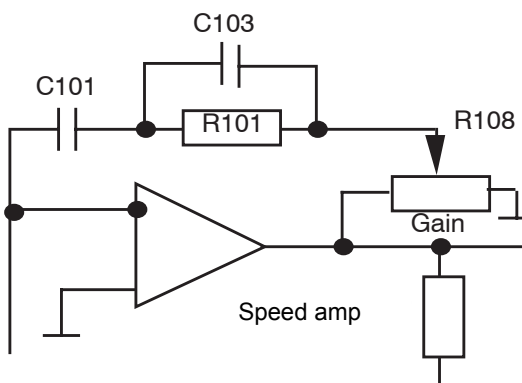

Equipment required

- Storage oscilloscope (digital if possible), easy to trip.
- Manual speed reference generator (battery box) or low frequency generator with series capacitor to produce zero mean speed (out and return about a position).
- Decade box for capacitor and resistor adjustment. Reference battery box, with oscillator for automatic control is available as an option.

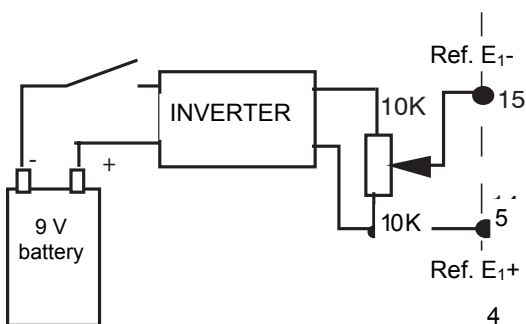

Method

FIG 1

Adjust the gain potentiometer to the centre (so gain may be varied up or down after adjustment).

Fit a large integration capacitor C101 - 10 μ F or strap.

Adjust proportional gain starting by R101 = 10 k Ω .

Speed recorded between N measurement and 0 V analogue

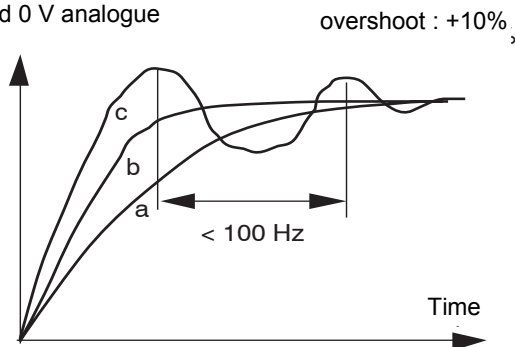

FIG 1 : a, b, c - graphs obtained with increasing R101 values

Increase R101 until 10% overshoot on speed reference increment. Always use small speed reference increments (e.g. ± 100 rpm or less) so the system remains linear. For large increments, current limitation (= torque limitation) masks the real situation and reduces overshoot.

The adjustment obtained with high speed increments would be incorrect.

In many cases, it is not possible to increase gain to produce overshoot especially for high inertia systems.

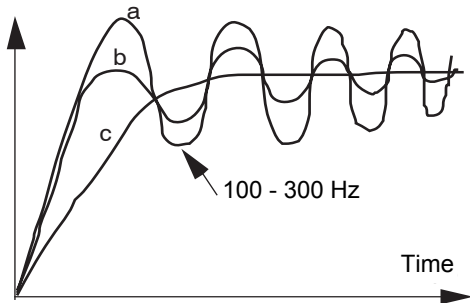

FIG. 2 : a, b, c, - graphs obtained with increasing C103 values

FIG 2

In some cases, gain limitation is due to resonance: the motor starts to whistle or vibrate at high frequencies (> 100 Hz). A -1 filter must be included at a frequency 3 to 4 times lower than the oscillation so the gain can be increased by the same ratio. This can be done by connecting a C103 capacitor in parallel with the R101 proportional gain resistor, and increasing the capacitor until the whistling stops (usually several tens of nF) and then continuing to increase gain while monitoring overshoot and torque ripple. The C103 10 nF capacitor is ready fitted as standard in parallel with the R101 gain resistor.

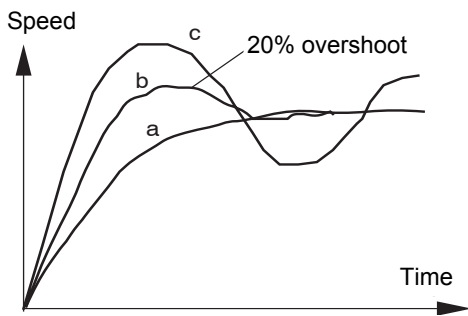
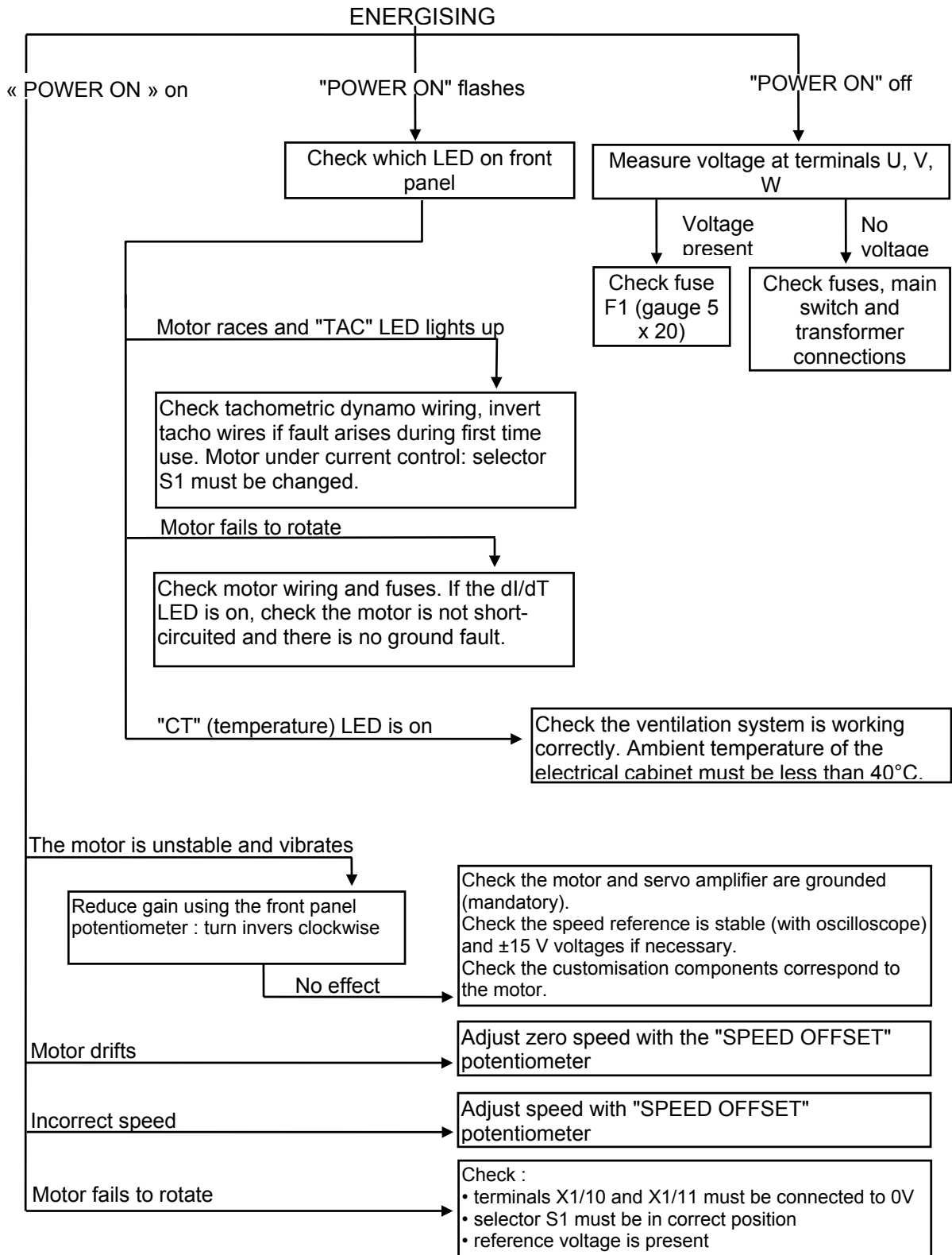

FIG 3 : a, b, c - graphs obtained with decreasing C101 values

FIG 3

When the gain is set, the C101 integration capacitor must be reduced to produce 15 - 20% overshoot (still for small speed increments).

7.3 - DIAGNOSTIC HELP



8. - COMMISSIONING FAULTS

a - check the connections to the following components:

transformer, relays, motor and any additional inductors, tachometer, controls.

b - with the speed and current (X1/10 and X1/11 not connected), connect the power to the controller. The "POWER ON" LED should light (if not check the transformer wiring and relays). If the "POWER ON" LED flashes, measure the transformer secondary voltage. Adjust the output voltage if necessary with the $\pm 5\%$ terminals. The motor then turns freely by hand.

c - Zero speed set point (X1/4 = X1/5 = 0 V), release the controller (X1/10 and X1/11 to 0 V) the motor must be under torque. If the motor races, cut the power and check the signals from the tachometer (cut-out or reversal) before switching on again ("RES" and/or "TAC" fault). If the motor howls or vibrates (possibly with "IFT" fault) reduce the controller gain with the front panel potentiometer. If the controller had switched to fault mode ("POWER ON" flashing), clear the fault by resetting (X1/12 to 0 V).

d - Gradually increase the controller set point and observe motor acceleration. Check the motor rotates in the opposite direction when the set point is reversed. If a fault arises on reversal for a 10 V set point, adjust the controller gain (see paragraph e). If the fault persists, wire the power transformer secondary to the -5% terminals ("MAU" fault on LED strip).

e - Adjust the front panel settings if necessary

- SPEED offset: zero speed at zero set point (adjust when warm)
- SPEED adj: fine adjustment of speed for 10 V set point
- GAIN: turn clockwise to find the point of "instability" of the motor and its load (adjustment may vary with load inertia and elasticity), then move back by one or two revolutions.
- The point of "instability" may or may not be reached depending on the motor load. The adjustment range can be shifted by increasing resistor R101.

COMMISSIONING FAULTS:

TACH FAULT:	overspeed, speed signal reversed or cut out
OVER TEMP.:	excessive dissipater temperature
UNDER VOLTAGE:	AC supply voltage too low unsuitable transformer
OVER VOLTAGE:	excessive energy return from load excessive AC supply voltage insufficient controller gain
OVER CURRENT:	defective motor wiring AXEM motor wired up without additional inductor
IF(t):	excessive controller gain over-restrictive operating cycle

NO DISPLAY ON "POWER ON" AND FAULT DIODES:

- transformer wiring - protective fuse
- RTS internal fuse

9. - RAMP OPTION

The RG6602 ramp card slots into the RR6606 regulation card (Y5 must be in the off position: solder tag removed). The ramp time value is adjustable by direction of rotation with potentiometers R1 and R2. The time can be adjusted from 0.6 sec to 6 sec for a set point of 10 V. Time is increased by turning the potentiometers clockwise.

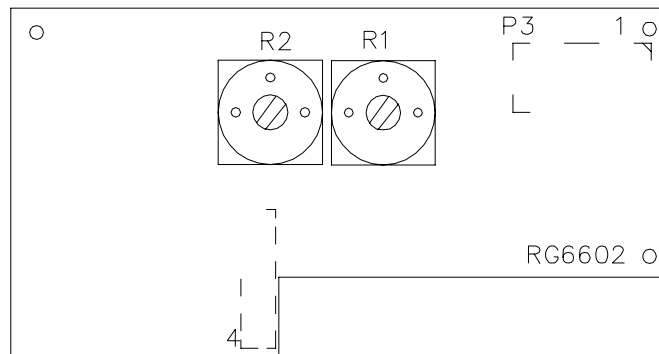

Slopes A and B can be adjusted separately.
Slope A = potentiometer R2
Slope B = potentiometer R1

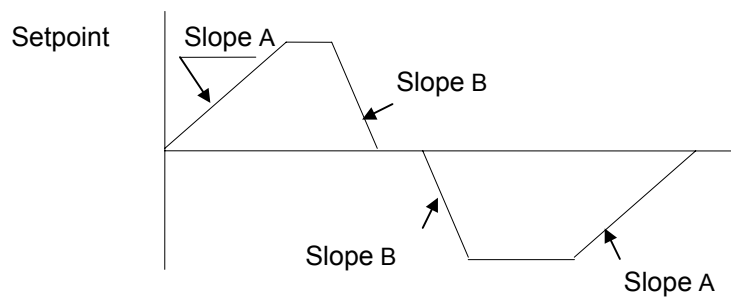

10. - BATTERY OPERATED RTS 40/80 FEATURES

10.1 - Electrical Characteristics

- Power supply	Battery voltage 17 - 90 V
- Output voltage	Ubatt - 2 V
- Recovery	None
- Minimum inductance	0.2 mH
- Total dissipation	70 W

10.2 - X3 Terminal Connection

- X3/1: Battery -
- X3/2: Battery +
- X3/3: Earth, to be connected to earth bar

10.3 - Adaptation to U-RI Function (R133, R134)

Use Ub voltage equals voltage battery, depending on the, in the formulas for calculating these two resistances.

$$R133 = 4 \frac{Ub}{Ke} \text{ or } \frac{280}{Ke} \text{ with RD6607B}$$

$$R134 = \frac{15000.r}{Ub} \text{ or } 203r \text{ with RD6607B}$$

10.4 - Adaptation to dc voltage (RB)

voltage battery V	resistance RB KΩ	Umin V	Umax V
24	56,2	16	33
36	150	27	58
48	274	31	68
72	no RB resistance	43	93

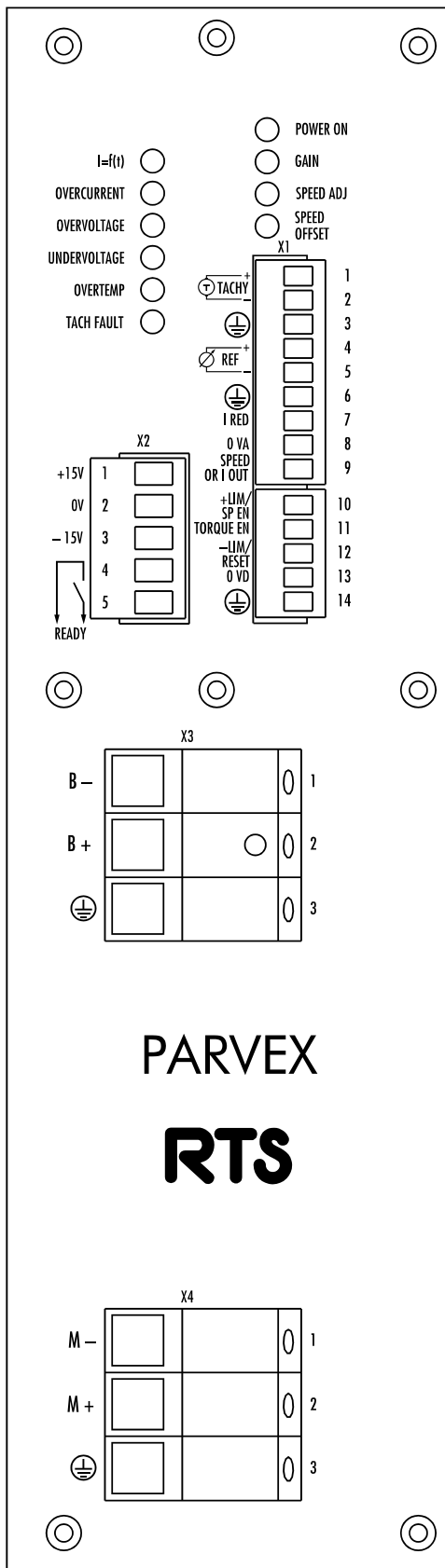

PARVEX

RTS

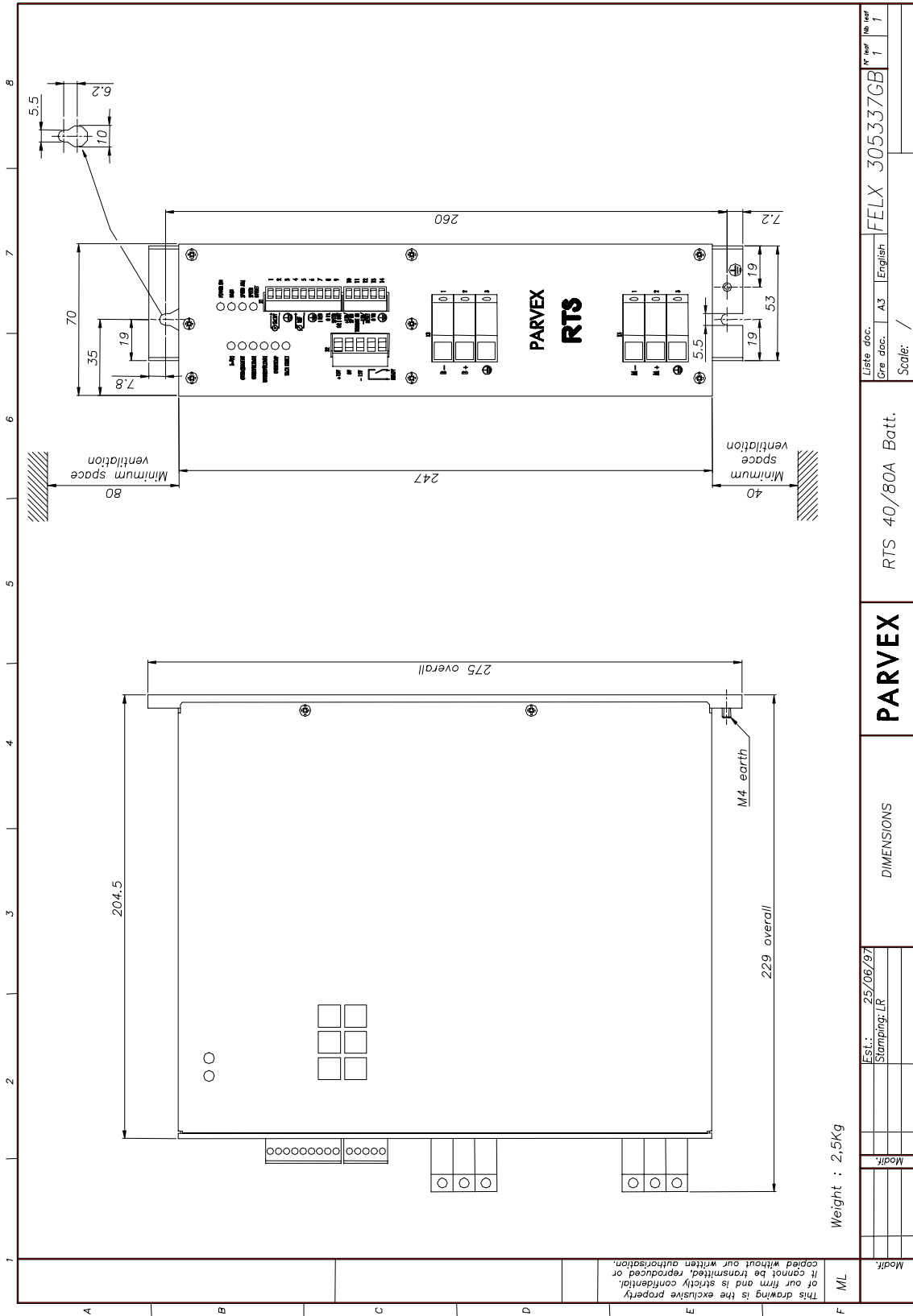

Modif.	Est.: 25/06/97 Stamping: LR	DIMENSIONS	PARVEX	RTS 40/80A Batt.	Liste doc.	FELX 305337GB	N° ref	1
					Cre. doc.	A3	English	
					Scale: /			

This drawing is the exclusive property of our firm and is strictly confidential. It cannot be transmitted, reproduced or copied without our written authorisation.

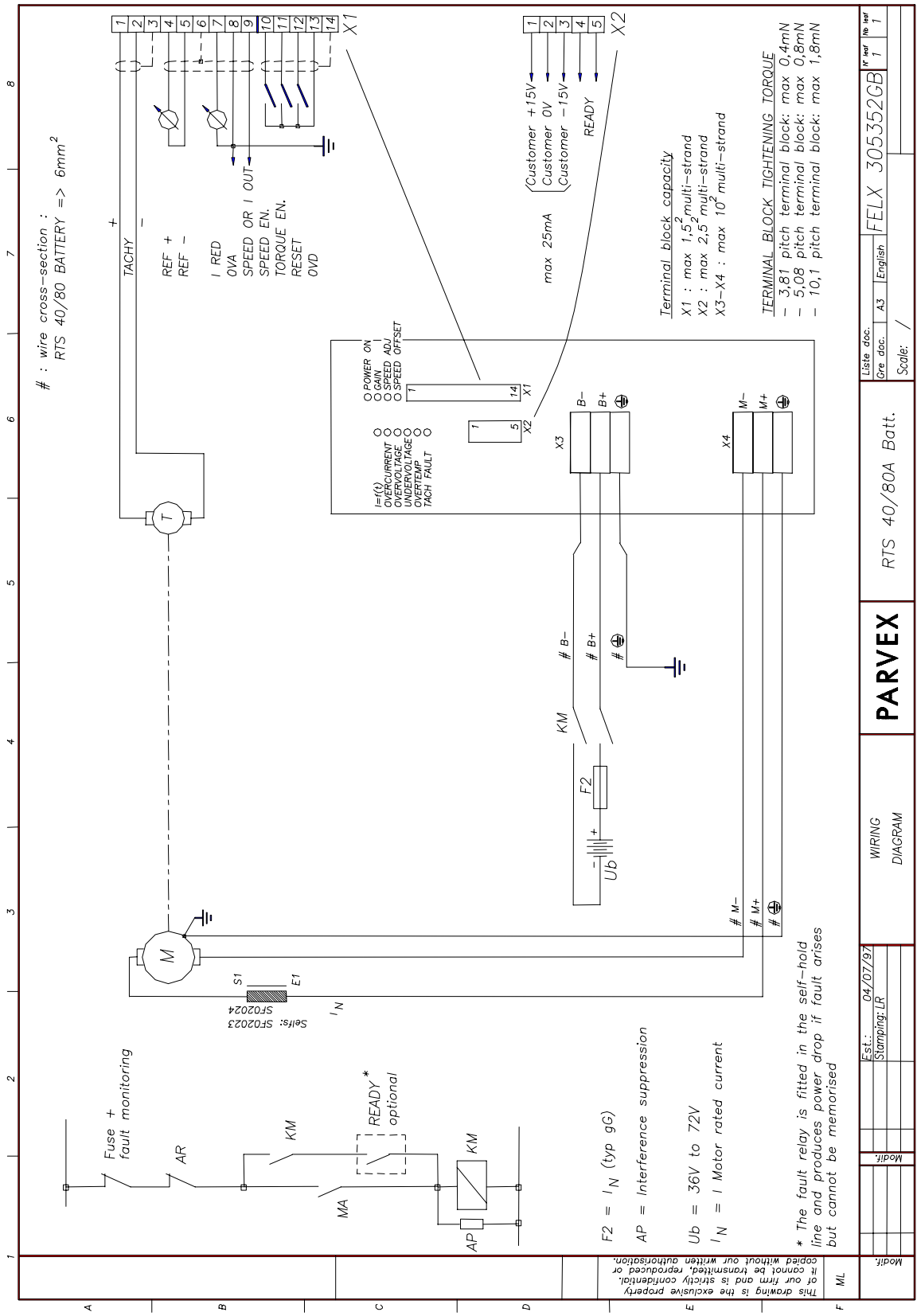

ML	This drawing is the exclusive property of our firm and is strictly confidential. It cannot be transmitted, reproduced or copied without our written authorisation.	
F	Modif:	
E	Est.: 04/07/97	Stamping: LR
D	WIRING DIAGRAM	RTS 40/80A Batt.
C	PARVEX	
B	Gre. doc. A3	English English
A	Liste doc. FELX 305352GB	1 1

11. - ADDITIONAL RESISTOR TYPE RTS 40/80 SPECIAL FEATURES

11.1 - Description

The additional resistor type RTS 40/80 drive has an extra terminal block X5 for connecting the external resistor.

- The sales reference is: RTS 73204R8R
- The minimum value of resistor that can be connected is 4.5 Ω . The resistor must have a high pulse capacity: greater than 25 times 500 W for 2 seconds (25 kJ).
- The 9 Ω RE69004 resistor that can be used **must be fan-cooled**.

Caution : Connections to X5 terminals 1 and 2 must be insulated and made with conductors of suitable cross-section (1 mm²).

Any short-circuit between them or with the casing or other conductors may permanently damage the drive.

11.2 - Dimensions

11.3 - Front Panel

