

Shock Absorbers

The use of one piece / closed end bodies and inner pressure chambers provides extremely strong construction, which can withstand much higher internal pressures and overload forces without mechanical damage.

The closed end / one piece bodies and inner pressure chambers, reduces the chance of sudden failure, or machine damage in the event of an overload.

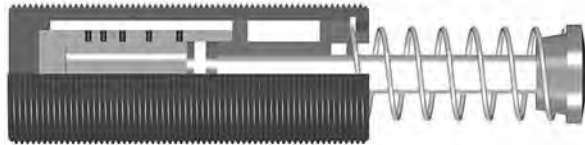

B

Shock Absorbers
 Actuator Products

Shock
 Absorbers

Specifications

	Oil type	Materials	Mechanical stop	Lock nut
MC 9 - MC 75	Silicone	Steel body: Black oxide finish. Piston rod: Hardened stainless steel.		Included
MC 150 - MC 600	Silicone	Steel body: Black oxide finish. Piston rod: Hardened stainless steel. Rolling seal: EPDM*	Must be provided 0.02 to 0.04 inch (0.5 to 1 mm) before end of stroke.	Included
SC 190 - SC 925	#5	Steel body: Black oxide finish. Piston rod: Hardened stainless steel.	Integral mechanical stop built into front of units.	Included
SC 300 - SC 650	#5	Steel body: Black oxide finish. Piston rod: Hardened stainless steel.	Integral mechanical stop built into front of units.	Included
MA 35 - MA 900	MA 35: #5 MA 150: Silicone MA 225, 600, 900: ATF	Steel body: Black oxide finish. Piston rod: Hardened stainless steel.	Adjustment screw for optimum deceleration.	Included
MC 33 - MC 64 Self-Compensating	ATF	Steel body: Black oxide finish. Piston rod: Hardened, high tensile steel, chrome plated.		Included
MC 33 - MC 64 Adjustable	ATF	Rod end button: Hardened steel with black oxide finish. Return spring: Zinc plated	Turn front stop collar or rear adjuster against the scale marked 0 to 9 for optimum deceleration	Included
1-1/2" Bore Series	American 46	Steel body: Black oxide finish. Piston rod: Hardened, high tensile steel, chrome plated. Return spring: Zinc plated	Must be provided .09 inch (2.3 mm) before end of stroke.	
CA 2 - CA 4 Self-Compensating	ATF	Steel body: Black oxide finish. Piston rod: Hardened, high tensile steel, chrome plated.	Must be provided .09 inch (2.3 mm) before end of stroke.	
A 2 - A 3 Adjustable	ATF	Return spring: Zinc plated	Must be provided .09 inch (2.3 mm) before end of stroke.	

* Seal not compatible with petroleum based fluids) If unit to be used in contact with such fluids specify neoprene rolling seal. Consider the SC2 Series as an alternative.

**Miniature shock absorbers
 MC 9 to MC 75
 Self-compensating**

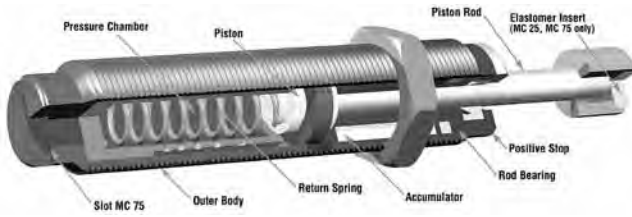

**MA series 225-900 shock absorbers
 (Miniature adjustable)
 Adjustable**

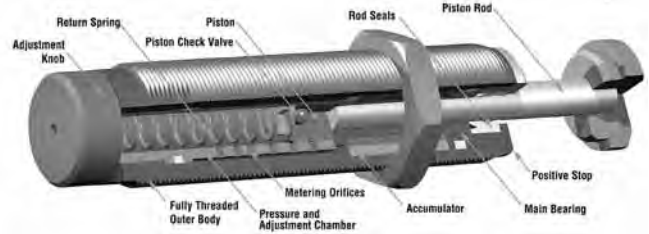

**Miniature shock absorbers
 MC 150, MC 225 and MC 600
 Self-Compensating**

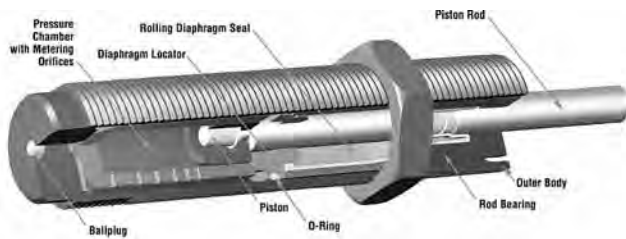

**Magnum series MA and ML 33 to 64
 Adjustable**



**Heavyweight shock absorbers
 SC 300 and SC 650
 Soft Contact and Self-Compensating**

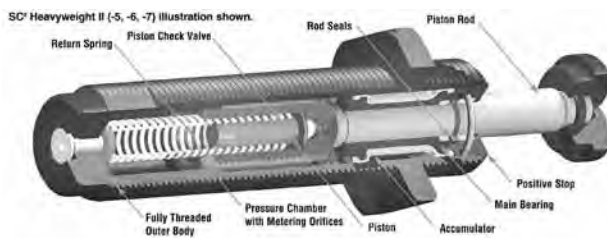

**Heavy industrial shock absorbers
 CA to CA 4
 Self-Compensating**

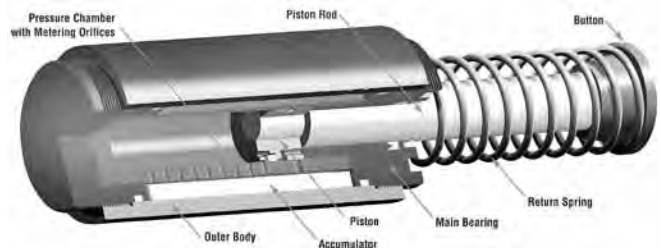

**Miniature shock absorbers
 SC 190 to SC 925
 Soft Contact and Self-Compensating**

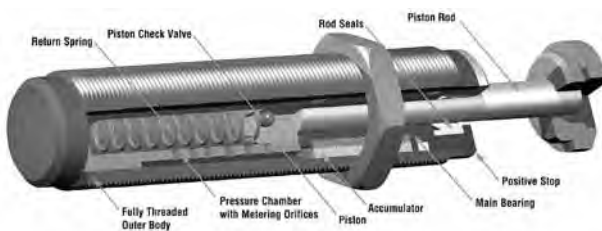

**Heavy industrial shock absorbers
 A2 to A3
 Adjustable**

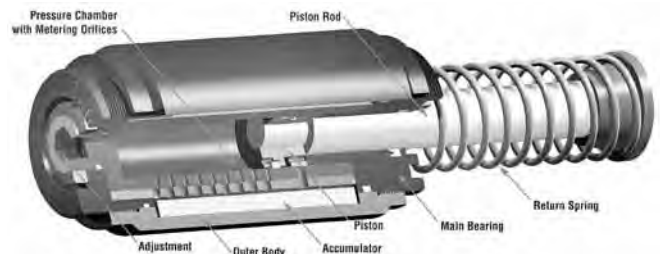

B
 Shock Absorbers
 Actuator Products
 Shock Absorbers

Miniature Shock Absorbers MC 9 to MC 75 - Self-Compensating

Miniature Shock Absorbers are self-contained hydraulic units. The MC 9 to MC 75 model range has a very short overall length and low return force. Its small size allows for high energy absorption in confined spaces, while the wide effective weight ranges accommodate a variety of load conditions. With threaded outer bodies and multiple accessories, MC models can be mounted in numerous configurations.



Operating information

Impact velocity range:

MC 9:	0.5 to 6 ft/sec (0.15 to 1.8 m/sec)
MC 10:	0.5 to 5 ft/sec (0.15 to 1.5 m/sec)
MC 25:	0.5 to 8 ft/sec (0.15 to 2.4 m/sec)
MC 75:	0.5 to 12 ft/sec (0.15 to 3.66 m/sec)

Operating temperature:

MC 9 and MC 10:	14°F to 158°F (-10°C to 70°C)
MC 25:	32°F to 150°F (0°C to 66°C)
MC 75:	32°F to 150°F (0°C to 66°C)

Ordering information – Miniature MC series, self compensating

MC	75	□	-1	□
MC series	Model number	Mounting thread	Effective weight	Button options
	9	MC9	MC9	MC9 & MC10
	10	M M6 x 1.0 metric	-1 Light	Standard, no button
	25	MC10	-2 Medium	-B Delrin button
	75	M M8 x 1.0 metric	MC10	MC25 & MC75
		E M8 x 0.75 metric	L Light range	Standard, with button
		MC25	H Heavy range	-NB *No button, short rod
		Standard (UNEF)	MC25	-880 No button, standard rod
		M Metric	L Light range	
		MC75	Standard range	
		Standard (UNEF)	H Heavy range	
		M Metric	MC75	
			-1 Light	
			-2 Medium	
			-3 Heavy	

* Consult factory for dimensional details.

Stroke inches 1 inch = 25.4 mm	E3 max. energy per cycle, inch lbs 1 in lb = .11 Nm	We effective weight lbs, 1 lb = .45 kg	E4 max. energy per hour, in lbs/hour 1 in lb/hour = .11 Nm/hour			Model number
			Self-contained	A/O tank	A/O Re-circulating	
0.20	9	1.35-7.0	18,000	N/A	N/A	MC 9-1
0.20	9	1.75-9.0	18,000			MC 9-2
0.20	4	0.75-6.0	35,000	N/A	N/A	MC 10L
0.20	7	1.5-11	35,000			MC 10H
0.25	20	1.5-5	120,000			MC 25L
0.25	20	4-12	120,000	N/A	N/A	MC 25
0.25	20	10-30	120,000			MC 25H
0.40	75	0.5-2.5	250,000			MC 75-1
0.40	75	2-14	250,000	N/A	N/A	MC 75-2
0.40	75	6-80	250,000			MC 75-3

Miniature Shock Absorbers MC 150 to MC 600 - Self-Compensating

Miniature Shock Absorbers

MC 150 to MC 600 model range, feature a hermetically sealed rolling diaphragm seal system that provides the highest possible cycle lifetime and an extremely low rod return force. These models can be directly mounted into the end cover of pneumatic cylinders to provide superior damping compared to normal cylinder cushions. Use of the optional stop collar is recommended to provide a positive mechanical stop. By adding the optional side load adapter (metric threaded models only), it is possible to accept side loads up to 25° from the axis.



Operating information

Impact velocity range: 0.26 to 19.7 ft/sec (0.08 to 6 m/sec)
 Operating temperature: 32°F to 150°F (0°C to 66°C)

Note: MC 150 to MC 600 models may be mounted into pressure chambers of pneumatic actuators.

Ordering information – Miniature MC series, self compensating

MC	225	□	-1	□
MC series	Model number	Mounting thread		Effective weight
	150	-	MC150, MC255, MC600	
	255	M	Standard range	
	600	ME*	H Heavy range	
		ML**	H2 Extra heavy range	
			Button options	
			Standard, no button	
			-B Delrin button	
			-BS Steel button	

*MC 150 only **MC 600 only

Stroke inches 1 inch = 25.4 mm	E3 max. energy per cycle, inch lbs 1 in lb = .11 Nm	We effective weight lbs, 1 lb = .45 kg	E4 max. energy per hour, in lbs/hour 1 in lb/hour = .11 Nm/hour			Model number
			Self-contained	A/O tank	A/O Re-circulating	
0.50	150	2-22	300,000			MC 150
0.50	150	20-200	300,000	N/A	N/A	MC 150H
0.50	150	150-450	300,000			MC 150H2
0.50	225	5-55	400,000			MC 225
0.50	225	50-500	400,000	N/A	N/A	MC 225H
0.50	225	400-2,000	400,000			MC 225H2
1.00	600	20-300	600,000			MC 600
1.00	600	250-2,500	600,000	N/A	N/A	MC 600H
1.00	600	880-5,000	600,000			MC 600H2

B
Shock Absorbers
Actuator Products
Shock
Absorbers

SC² Series SC 190 to SC 925 - Soft Contact & Self-Compensating

SC² Series Miniature Shock Absorbers provide dual performance benefits. They offer **soft contact deceleration** where initial impact reaction forces are very low, with the advantages of **self-compensation** to react to changing energy conditions, without adjustment. They have long stroke lengths, **SC² 925 with 1.58 inch (40 mm) superstroke**, to provide smooth deceleration and low reaction forces.



Operating information

Impact velocity range: 0.5 to 12 ft/sec (0.15 to 3.66 m/sec)
 Operating temperature: 32°F to 150°F (0°C to 66°C)

Note: Integral mechanical stop built into front of units.

Ordering information – Miniature SC² series, soft contact and self compensating

SC	300	□	-1	□
SC ² series Soft Contact Self Compensating	Model number 190 300 650 925	Mounting thread – Standard (UNF) M Metric	Effective weight -1 Ultra light -2 Light -3 Medium -4 Heavy	Button options Standard with button -NB No button, short rod -BS No button, standard rod

Stroke inches 1 inch = 25.4 mm	E3 max. energy per cycle, inch lbs 1 in lb = .11 Nm	We effective weight lbs, 1 lb = .45 kg	E4 max. energy per hour, in lbs/hour 1 in lb/hour = .11 Nm/hour			Model number
			Self-contained	A/O tank	A/O Re-circulating	
0.63	225	3-15	300,000			SC 190-1
0.63	225	8-40	300,000			SC 190-2
0.63	225	20-100	300,000	N/A	N/A	SC 190-3
0.63	225	50-225	300,000			SC 190-4
0.75	300	3-18	400,000			SC 300-1
0.75	300	10-60	400,000			SC 300-2
0.75	300	30-180	400,000	N/A	N/A	SC 300-3
0.75	300	70-450	400,000			SC 300-4
1.00	650	17-100	600,000			SC 650-1
1.00	650	50-300	600,000			SC 650-2
1.00	650	150-900	600,000	N/A	N/A	SC 650-3
1.00	650	450-2,600	600,000			SC 650-4
1.58	975	30-200	800,000			SC 925-1
1.58	975	90-600	800,000			SC 925-2
1.58	975	250-1,600	800,000	N/A	N/A	SC 925-3
1.58	975	750-4,600	800,000			SC 925-4

B

Shock Absorbers
 Actuator Products

Shock
 Absorbers

SC² Heavyweight Series SC 300 to SC 650 - Soft Contact & Self-Compensating

SC² 300 and SC² 650 Heavyweight Series Shock Absorbers deliver up to 950% of the effective weight capacity and 280% of the energy absorption capability of standard models. These durable units are ideal for decelerating heavy weights moving at low velocities. The Heavyweight Series design combines the piston and the inner tube into a single component, the piston tube. It acts as both the pressure creating and pressure controlling device.



Operating information

Impact velocity range: 0.3 to 12 ft/sec (0.9 to 3.66 m/sec)
 Operating temperature: 32°F to 150°F (0°C to 66°C)

Note: Integral mechanical stop built into front of units.

Ordering information – SC² series, soft contact and self compensating

SC	300	□	-1	□
SC² series Soft Contact Self Compensating	Model number 300 650	Mounting thread – Standard (UNF) M Metric	Effective weight -5 Heavy -6 Heavy plus -7 Heavy duty -8 Extra heavy -9 Ultra heavy	Button options Standard with button -NB No button, short rod -880 No button, standard rod

Stroke inches 1 inch = 25.4 mm	E3 max. energy per cycle, inch lbs 1 in lb = .11 Nm	We effective weight lbs, 1 lb = .45 kg	E4 max. energy per hour, in lbs/hour 1 in lb/hour = .11 Nm/hour			Model number
			Self-contained	A/O tank	A/O Re-circulating	
0.59	650	25-100	400,000			SC 300-5
0.59	650	75-300	400,000			SC 300-6
0.59	650	200-400	400,000	N/A	N/A	SC 300-7
0.59	620	300-1,500	400,000			SC 300-8
0.59	620	700-4,300	400,000			SC 300-9
0.91	1,860	50-250	600,000			SC 650-5
0.91	1,860	200-800	600,000			SC 650-6
0.91	1,860	700-2,400	600,000	N/A	N/A	SC 650-7
0.91	1,860	1,700-5,800	600,000			SC 650-8
0.91	1,860	4,000-14,000	600,000			SC 650-9

B
 Shock Absorbers
 Actuator Products
 Shock
 Absorbers

Miniature Shock Absorbers MA 35 to MA 900 - Adjustable

MA Series miniature shock absorbers offer a compact design with true linear deceleration, and are adjustable over a wide range of conditions. If your preference is a fully adjustable shock absorber rather than a self-compensating model on your application, then the MA Series provides a directly interchangeable alternative.



Operating information

Impact velocity range:
 MA35 3.3 ft/sec (1.0 m/sec)
 MA150, 225, 600, 900 0.5 to 12 ft/sec (0.15 to 3.66 m/sec)
 Operating temperature: 32°F to 150°F (0°C to 66°C)

Ordering information – MA series, adjustable

MA	225	-	□
MA series MA – Miniature Adjustable	Model number 35 150 225 600 900	Mounting thread - Standard (UNF) M Metric ME Fine metric (MA 150 Only)	Button options MA35 Standard with button -NB No button, short rod MA150 Standard, no button -B Nylon button -BS Steel button MA 225-900 Standard steel button -NB No button, short rod -880 No button, standard rod

Stroke inches 1 inch = 25.4 mm	E3 max energy per cycle, inch lbs 1 in lb = .11 Nm	We effective weight lbs, 1 lb = .45 kg	E4 max energy per hour, in lbs/hour 1 in lb/hour = .11 Nm/hour			Model number
			Self-contained	A/O tank	A/O Re-circulating	
0.40	35	13-125	53,000			MA 35
0.50	150	2-200	300,000			MA 150
0.75	225	5-500	400,000	N/A	N/A	MA 225
1.00	600	20-3,000	600,000			MA 600
1.58	900	30-4,500	800,000	1,100,000 1,200,000	1,500,000 1,600,000	MA 900

B

Shock Absorbers
 Actuator Products

Shock Absorbers

Magnum Series MC 33 to MC 64 - Self-Compensating

The **Magnum Series** offer you the capability to mount shock absorbers that contain the highest energy capacity ratings in the industry. **Up to 150% of the energy per cycle** of previous models in the same package size, means increased safety factors in a wider range of applications.

Up to 390% of the effective weight capacity of previous models, may allow a smaller, lower priced shock absorber to be mounted, to meet your application requirements.



Operating information

Impact velocity range:
 MC Models: 0.5 to 16.5 ft/sec (0.15 to 5 m/sec)
 Operating temperature: 10°F to 150°F (-12°C to 66°C)

Ordering information – MC series, self compensating

MC		3325			-		1		C	
Return method and accumulator style		Model number			Mounting thread		Effective weight		Mounting options	
MC	Self-contained spring return, internal accumulator	3325	4525	6450	-	Standard (UNF)	-1	Light range		Standard mount
MCA	Air return, external accumulator	3350	4550	64100	M	Metric	-2	Medium range		Flanged stop collar
MCS	Spring return, external accumulator	3625	4575	64150			-3	Heavy range		Rectangular flange*
MCN	Self return (clevis), internal accumulator	3650					-4	Heavier range		Square flange*
									-C	Clevis mount**
									-P	Side-foot mount**
									-Z	Within air cylinder

* Welded versions available upon request.
 ** Not available on MC 3625 and 3650 models.

Self-Compensating Models

Stroke inches 1 inch = 25.4 mm	E3 max. energy per cycle, inch lbs 1 in lb = .11 Nm	We effective weight lbs, 1 lb = .45 kg	E4 max. energy per hour, in lbs/hour 1 in lb/hour = .11 Nm/hour			Model number
			Self-contained	A/O tank	A/O Re-circulating	
0.91	1,350	20-80 68-272 230-920 780-3,120	670,000	1,100,000	1,500,000	MC 3325-1 MC 3325-2 MC 3325-3 MC 3325-4
1.91	2,700	40-160 136-544 460-1,840 1,560-6,240	760,000	1,200,000	1,600,000	MC 3350-1 MC 3350-2 MC 3350-3 MC 3350-4
0.91	1,350	20-80 68-272 230-920 780-3,120	670,000	1,100,000	1,500,000	MC 3625-1 MC 3625-2 MC 3625-3 MC 3625-4
1.91	2,700	40-160 136-544 460-1,840 1,560-6,240	760,000	1,200,000	1,600,000	MC 3650-1 MC 3650-2 MC 3650-3 MC 3650-4
0.91	3,000	50-200 170-680 575-2,300 1,950-7,800	950,000	1,400,000	1,700,000	MC 4525-1 MC 4525-2 MC 4525-3 MC 4525-4
1.91	6,000	100-400 340-1,360 1,150-4,600 3,900-15,600	1,000,000	1,700,000	2,200,000	MC 4550-1 MC 4550-2 MC 4550-3 MC 4550-4
2.91 1.91	9,000	150-600 510-2,040 1,730-6,920 5,850-23,400	1,300,000	2,000,000	2,500,000	MC 4575-1 MC 4575-2 MC 4575-3 MC 4575-4
	15,000	300-1,200 1,020-4,080 3,460-13,840 11,700-46,800	1,300,000	2,600,000	3,400,000	MC 6450-1 MC 6450-2 MC 6450-3 MC 6450-4
3.91	30,000	600-2,400 2,040-8,160 6,920-27,680 23,400-93,600	1,700,000	3,400,000	4,400,000	MC 64100-1 MC 64100-2 MC 64100-3 MC 64100-4
5.91	45,000	900-3,600 3,060-12,240 10,380-41,520 35,100-140,400	2,200,000	4,400,000	5,700,000	MC 64150-1 MC 64150-2 MC 64150-3 MC 64150-4

Magnum Series MA & ML 33 to 64 - Adjustable

Magnum Series adjustable shock absorbers feature the latest seal technology, a hardened piston ring, pressure chamber and outer body for increased operating life. Additionally, these rugged units offer the unique feature of front or rear adjustment along with a fully threaded outer body for ease of installation.

Along with the self-compensating models, the adjustable range offers unprecedented increases in energy and effective weight capacity.



Operating information

Impact velocity range:

MA Models 0.5 to 16.5 ft/sec (0.15 to 5 m/sec)

ML Models 0.06 to 1.5 ft/sec (0.02 to 0.46 m/sec)

Operating temperature: 10°F to 150°F (-12°C to 66°C)

Ordering information – MA & ML (low velocity) series, adjustable

MA		3325					C	
Return method and accumulator style		Model number			Mounting thread		Mounting options	
MA	Self-contained spring return, internal accumulator	3325	4525	6450	-	Standard (UNF)		Standard mount
MAA	Air return, external accumulator	3350	4550	64100	M	Metric		Flanged stop collar
MAS	Spring return, external accumulator	3625	4575	64150				Rectangular flange*
MAN	Self return (clevis), internal accumulator	3650						Square flange*
ML	Self-contained spring return, internal accumulator*						-C	Clevis mount**
MLA	Air return, external accumulator*						-S	Side-foot mount**
MLS	Spring return, external accumulator*						-P	Side port
MLN	Self return (clevis), internal accumulator*						-Z	Within air cylinder

* Low velocity

* Welded versions available upon request.

** Not available on ML 3625 and 3650 models.

Stroke inches 1 inch = 25.4 mm	E3 max energy per cycle, inch lbs 1 in lb = .11 Nm	We effective weight lbs, 1 lb = .45 kg	E4 max energy per hour, in lbs/hour 1 in lb/hour = .11 Nm/hour			Model number
			Self-contained	A/O tank	A/O Re-circulating	
0.91	1,500	20-3,800	670,000	1,100,000	1,500,000	MA 3325
1.91	3,000	28-5,400	760,000	1,200,000	1,600,000	MA 3350
0.91	1,500	20-3,800	670,000	1,100,000	1,500,000	MA 3625
1.91	3,000	28-5,400	760,000	1,200,000	1,600,000	MA 3650
0.91	3,450	95-22,000	950,000	1,400,000	1,700,000	MA 4525
1.91	6,900	150-32,000	1,000,000	1,700,000	2,200,000	MA 4550
2.91	10,350	155-33,000	1,300,000	2,000,000	2,500,000	MA 4575
1.91	18,000	480-110,000	1,300,000	2,600,000	3,400,000	MA 6450
3.91	36,000	600-115,000	1,700,000	3,400,000	4,400,000	MA 64100
5.91	54,000	730-175,000	2,200,000	4,400,000	5,700,000	MA 64150
0.91	1,500	.05-1.5	670,000	1,100,000	1,500,000	ML 3325
1.91	3,000	.05-1.5	760,000	1,200,000	1,600,000	ML 3350
0.91	1,500	.05-1.5	670,000	1,100,000	1,500,000	ML 3625
1.91	3,000	.05-1.5	760,000	1,200,000	1,600,000	ML 3650
0.91	3,450	.05-1.5	950,000	1,400,000	1,700,000	ML 4525
1.91	6,900	.05-1.5	1,000,000	1,700,000	2,200,000	ML 4550
0.91	9,000	.05-1.5	1,100,000	2,200,000	2,900,000	ML 6425
1.91	18,000	.05-1.5	1,300,000	2,600,000	3,400,000	ML 6450

1-1/2" Bore Series - Adjustable

1-1/2" bore series shock absorbers are designed for the toughest environments. These durable adjustable models provide outstanding deceleration over a wide range of effective weight conditions. Large energy capacities stop heavy loads set into motion by high propelling forces, without damage.



Operating information

Impact velocity range: 0.5 to 15 ft/sec (0.15 to 4.5 m/sec)
 Operating temperature: 10°F to 150°F (-12°C to 66°C)

Ordering information – 1-1/2" bore series, adjustable

A	1-1/2	6-1/2	F
Return method and accumulator style	Bore size	Stroke length	Mounting style
A Spring return, internal accumulator	1-1/2	2	-F Front flange
AA Air return, external accumulator		3-1/2	-R Rear flange
SA Spring return, external accumulator		5	-RF Front rectangular flange
NA Self return (clevis), internal accumulator		6-1/2	-RR Rear rectangular flange
			-S Side foot mount
			-C Clevis mount

Stroke inches 1 inch = 25.4 mm	E3 max energy per cycle, inch lbs 1 in lb = .11 Nm	We effective weight lbs, 1 lb = .45 kg	E4 max energy per hour, in lbs/hour 1 in lb/hour = .11 Nm/hour			Model number
			Self-contained	A/O tank	A/O Re-circulating	
2.00	16,000	430-70,000	3,200,000	4,000,000	5,200,000	1-1/2x2
3.50	28,000	480-80,000	5,600,000	7,000,000	9,100,000	1-1/2x3-1/2
5.00	40,000	500-90,000	8,000,000	10,000,000	13,000,000	1-1/2x5
6.50	52,000	680-100,000	10,400,000	13,000,000	17,000,000	1-1/2x6-1/2

B
Shock Absorbers
Actuator Products
Shock Absorbers

Heavy Industrial Shock Absorbers CA 2 to CA 3 - Self-Compensating

CA 2" & CA 3" Bore Series of self-compensating shock absorbers are designed for extremely heavy duty applications and provide smooth deceleration under changing conditions. High energy capacities combined with wide effective weight ranges qualify these units to perform in the most demanding environments.



Operating information

Impact velocity range: 1 to 16.5 ft/sec (0.30 to 5 m/sec)
 Operating temperature: 10°F to 150°F (-12°C to 66°C)

Ordering information – CA 2 & CA 3 series, self-compensating

CA	2	x	8	R	-	3																																													
<table border="1"> <thead> <tr> <th colspan="2">Return method and accumulator style</th> </tr> </thead> <tbody> <tr> <td>CA</td> <td>Spring return, internal accumulator</td> </tr> <tr> <td>CAA</td> <td>Air return, external accumulator</td> </tr> <tr> <td>CSA</td> <td>Spring return, external accumulator</td> </tr> <tr> <td>CNA</td> <td>Self return (clevis), internal accumulator</td> </tr> </tbody> </table>		Return method and accumulator style		CA	Spring return, internal accumulator	CAA	Air return, external accumulator	CSA	Spring return, external accumulator	CNA	Self return (clevis), internal accumulator	<table border="1"> <thead> <tr> <th>Bore size</th> </tr> </thead> <tbody> <tr> <td>2</td> </tr> <tr> <td>3</td> </tr> </tbody> </table>	Bore size	2	3	<table border="1"> <thead> <tr> <th>Stroke length</th> </tr> </thead> <tbody> <tr> <td>2</td> </tr> <tr> <td>4</td> </tr> <tr> <td>5</td> </tr> <tr> <td>6</td> </tr> <tr> <td>8</td> </tr> <tr> <td>10</td> </tr> <tr> <td>12</td> </tr> </tbody> </table>	Stroke length	2	4	5	6	8	10	12	<table border="1"> <thead> <tr> <th colspan="2">Mounting style</th> </tr> </thead> <tbody> <tr> <td>-F</td> <td>Front flange</td> </tr> <tr> <td>-R</td> <td>Rear flange</td> </tr> <tr> <td>-RF</td> <td>Front rectangular flange</td> </tr> <tr> <td>-RR</td> <td>Rear rectangular flange</td> </tr> <tr> <td>-S</td> <td>Side foot mount</td> </tr> <tr> <td>-C</td> <td>Clevis mount</td> </tr> </tbody> </table>		Mounting style		-F	Front flange	-R	Rear flange	-RF	Front rectangular flange	-RR	Rear rectangular flange	-S	Side foot mount	-C	Clevis mount	<table border="1"> <thead> <tr> <th colspan="2">Effective weight</th> </tr> </thead> <tbody> <tr> <td>-1</td> <td>Light</td> </tr> <tr> <td>-2</td> <td>Medium light</td> </tr> <tr> <td>-3</td> <td>Medium heavy</td> </tr> <tr> <td>-4</td> <td>Heavy</td> </tr> </tbody> </table>	Effective weight		-1	Light	-2	Medium light	-3	Medium heavy	-4	Heavy
Return method and accumulator style																																																			
CA	Spring return, internal accumulator																																																		
CAA	Air return, external accumulator																																																		
CSA	Spring return, external accumulator																																																		
CNA	Self return (clevis), internal accumulator																																																		
Bore size																																																			
2																																																			
3																																																			
Stroke length																																																			
2																																																			
4																																																			
5																																																			
6																																																			
8																																																			
10																																																			
12																																																			
Mounting style																																																			
-F	Front flange																																																		
-R	Rear flange																																																		
-RF	Front rectangular flange																																																		
-RR	Rear rectangular flange																																																		
-S	Side foot mount																																																		
-C	Clevis mount																																																		
Effective weight																																																			
-1	Light																																																		
-2	Medium light																																																		
-3	Medium heavy																																																		
-4	Heavy																																																		

Stroke inches 1 inch = 25.4 mm	E3 max energy per cycle, inch lbs 1 in lb = .11 Nm	We effective weight lbs, 1 lb = .45 kg	E4 max energy per hour, in lbs/hour 1 in lb/hour = .11 Nm/hour			Model number
			Self-contained	A/O tank	A/O Re-circulating	
2.00	32,000	1,600-4,800 4,000-12,000 10,000-30,000 25,000-75,000	9,600,000	12,000,000	15,600,000	CA 2x2-1 CA 2x2-2 CA 2x2-3 CA 2x2-4
4.00	64,000	3,200-9,600 8,000-24,000 20,000-60,000 50,000-150,000	12,000,000	15,000,000	19,500,000	CA 2x4-1 CA 2x4-2 CA 2x4-3 CA 2x4-4
6.00	96,000	4,800-14,400 12,000-36,000 30,000-90,000 75,000-225,000	14,400,000	18,000,000	23,500,000	CA 2x6-1 CA 2x6-2 CA 2x6-3 CA 2x6-4
8.00	128,000	6,400-19,200 16,000-48,000 40,000-120,000 100,000-300,000	16,800,000	21,000,000	27,000,000	CA 2x8-1 CA 2x8-2 CA 2x8-3 CA 2x8-4
10.00	160,000	8,000-24,000 20,000-60,000 50,000-150,000 125,000-375,000	19,200,000	24,000,000	31,000,000	CA 2x10-1 CA 2x10-2 CA 2x10-3 CA 2x10-4
5.00	125,000	6,400-19,200 16,000-48,000 40,000-120,000 100,000-300,000	20,000,000	25,000,000	32,500,000	CA 3x5-1 CA 3x5-2 CA 3x5-3 CA 3x5-4
8.00	200,000	10,240-30,720 25,600-76,800 64,000-192,000 160,000-480,000	32,000,000	40,000,000	52,000,000	CA 3x8-1 CA 3x8-2 CA 3x8-3 CA 3x8-4
12.00	300,000	15,360-46,080 38,400-115,200 96,000-288,000 240,000-720,000	48,000,000	60,000,000	78,000,000	CA 3x12-1 CA 3x12-2 CA 3x12-3 CA 3x12-4

Heavy Industrial Shock Absorbers CA 4 - Self-Compensating

CA 4" Bore Series of self-compensating shock absorbers are designed for extremely heavy duty applications and provide smooth deceleration under changing conditions. High energy capacities combined with wide effective weight ranges qualify these units to perform in the most demanding environments.



Operating information

Impact velocity range: 1 to 16.5 ft/sec (0.30 to 5 m/sec)
 Operating temperature: 10°F to 150°F (-12°C to 66°C)

Ordering information – CA 4 series, self-compensating

CA	4	x	8	R	-	5
Return method and accumulator style	Bore size		Stroke length	Mounting style		Effective weight
CA Spring return, internal accumulator	4		6	-F Front flange		-3 Light
CAA Air return, external accumulator			8	-R Rear flange		-5 Medium
CSA Spring return, external accumulator			16	-RP Rear standard		-7 Heavy
CNA Self return (clevis), internal accumulator				-FP Front standard		
				-FRP Front and rear standard		
				-S Side foot mount		
				-C Clevis mount		

Stroke inches 1 inch = 25.4 mm	E3 max energy per cycle, inch lbs 1 in lb = .11 Nm	We effective weight lbs, 1 lb = .45 kg	E4 max energy per hour, in lbs/hour 1 in lb/hour = .11 Nm/hour			Model number
			Self-contained	A/O tank	A/O Re-circulating	
6.00	420,000	8,000-19,000	27,000,000	45,000,000	58,000,000	CA 4x6-3
6.00	420,000	19,000-41,000	27,000,000	45,000,000	58,000,000	CA 4x6-5
6.00	420,000	41,000-94,000	27,000,000	45,000,000	58,000,000	CA 4x6-7
8.00	560,000	11,000-25,000	30,000,000	50,000,000	65,000,000	CA 4x8-3
8.00	560,000	25,000-55,000	30,000,000	50,000,000	65,000,000	CA 4x8-5
8.00	560,000	55,000-125,000	30,000,000	50,000,000	65,000,000	CA 4x8-7
16.00	1,120,000	22,000-50,000	50,000,000	85,000,000	110,000,000	CA 4x16-3
16.00	1,120,000	50,000-110,000	50,000,000	85,000,000	110,000,000	CA 4x16-5
16.00	1,120,000	110,000-250,000	50,000,000	85,000,000	110,000,000	CA 4x16-7

B
 Shock Absorbers
 Actuator Products
 Shock Absorbers

Heavy Industrial Shock Absorbers A 2 and A 3 - Adjustable

A 2 and A 3 Series adjustable shock absorbers are capable of decelerating heavy duty loads. These reliable units replace the former 2" and 3" large bore adjustable shock absorbers.

Features include a considerably reduced outer diameter, internal accumulator and threaded mounting brackets, easily adaptable to the front or rear of the outer body.



Operating information

Impact velocity range: 0.33 to 16.5 ft/sec (0.1 to 5 m/sec)
 Operating temperature: 10°F to 150°F (-12°C to 66°C)

Ordering information – A 2 & A 3 series, adjustable

A	2	x	8	-	R
Return method and accumulator style		Bore size	Stroke length	Mounting style	
A	Spring return, internal accumulator	2	2	-F	Front flange
AA	Air return, external accumulator	3	4	-R	Rear flange
SA	Spring return, external accumulator		5	-RF	Front rectangular flange
NA	Self return (clevis), internal accumulator		6	-RR	Rear rectangular flange
				-S	Side foot mount
				-C	Clevis mount

Note: A no button option is available on the 3" Bore only as a special.

Stroke inches 1 inch = 25.4 mm	E3 max energy per cycle, inch lbs 1 in lb = .11 Nm	We effective weight lbs, 1 lb = .45 kg	E4 max energy per hour, in lbs/hour 1 in lb/hour = .11 Nm/hour			Model number
			Self-contained	A/O tank	A/O Re-circulating	
2.00	32,000	560-170,000	9,600,000	12,000,000	15,600,000	A 2x2
4.00	80,000	510-160,000	12,000,000	15,000,000	19,500,000	A 2x4
6.00	120,000	570-190,000	14,400,000	18,000,000	23,500,000	A 2x6
8.00	170,000	580-200,000	16,800,000	21,000,000	27,000,000	A 2x8
10.00	210,000	720-250,000	19,200,000	24,000,000	31,000,000	A 2x10
5.00	140,000	1,050-340,000	20,000,000	25,000,000	32,500,000	A 3x5
8.00	250,000	1,200-400,000	32,000,000	40,000,000	52,000,000	A 3x8
12.00	390,000	1,350-450,000	48,000,000	60,000,000	78,000,000	A 3x12

B

Shock Absorbers
 Actuator Products

Shock
 Absorbers

Miniature Shock Absorber Side Load Adapters

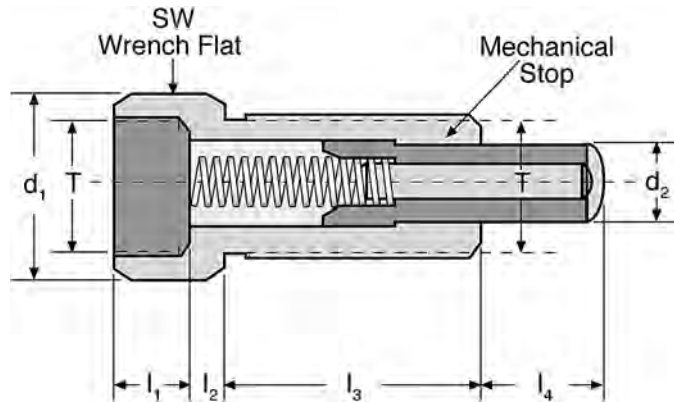

Dimensions Inches (Millimeters)

MC, MVC Series model	SC Series model	MA Series model	Side load adapter	T	d1	d2	l1	l2	l3	l4	SW	Maximum side load (α)
MC 150M	N/A	MA 150M	250-0558	M14 x 1.5	0.70 (18)	0.35 (9)	0.31 (8)	0.15 (4)	0.78 (20)	0.49 (12.5)	0.62 (16)	25°
MC 225M	N/A	N/A	250-0559	M20 x 1.5	0.94 (24)	0.47 (12)	0.39 (10)	0.15 (4)	0.78 (20)	0.49 (12.5)	0.86 (22)	25°
MC 600M	N/A	N/A	250-0560	M25 x 1.5	1.18 (30)	0.62 (16)	0.39 (10)	0.23 (6)	1.50 (38)	0.98 (25)	1.06 (27)	25°
N/A	SC190M-880*	N/A	250-0080	M14 x 1.5	0.70 (18)	0.35 (9)	0.39 (10)	0.15 (4)	1.02 (26)	0.62 (16)	0.62 (16)	25°
MVC 225M-880*	SC 300M-880*	MA 225M-880*	250-0081	M20 x 1.5	0.94 (24)	0.47 (12)	0.39 (10)	0.15 (4)	1.25 (32)	0.75 (19)	0.86 (22)	25°
MVC 600M-880*	SC 650M-880*	MA 600M-880*	250-0082	M25 x 1.5	1.18 (30)	0.62 (16)	0.39 (10)	0.23 (6)	1.50 (38)	0.98 (25)	1.06 (27)	25°

Note: Side load not to exceed 5". Maximum side load depends on application, shock absorber model, and stroke length.

Note: The side load adapter can only be installed on select metric shock absorbers without rod end button.

Magnum Series Group Accessories

Square and Rectangular Flanges Inches (Millimeters)

Used with	Square flange	Rect flange	T	M1	M2	M3	M4	M5	M6
MA 33 ML 33 MC 33		250-0016	1-1/4-12 UNF	1.50 (38.1)	2.00 (50.8)	0.38 (9.5)	.219 (5.6)	1.12 (28.4)	1.62 (41.2)
MA 33M ML 33M MC 33M	N/A	250-0293	M33x1.5	1.62 (41.1)	2.12 (53.8)	0.38 (9.5)	.278 (7.1)	1.10 (28.0)	1.65 (42.0)
MA 36 ML 36 MC 36		250-0633	1-3/8-12 UNF	1.75 (44.4)	2.00 (50.8)	0.38 (9.5)	.219 (5.6)	1.12 (28.4)	1.62 (41.2)
MA 36M ML 36M MC 36M	N/A	N/A	N/A	N/A	N/A	N/A	N/A	N/A	N/A
MA 45 ML 45 MC 45	250-0023	250-0024	1-3/4-12 UN	2.25 (57.2)	3.00 (76.2)	0.50 (12.7)	0.34 (8.7)	1.62 (41.2)	2.38 (60.5)
MA 45M ML 45M MC 45M	250-0298	250-0299	M45x1.5	2.25 (57.2)	3.00 (76.2)	0.50 (12.7)	0.35 (8.8)	1.62 (41.2)	2.38 (60.5)
MA 64 ML 64 MC 64	250-0028	N/A	2-1/2-12 UN	3.50 (88.9)	N/A	0.62 (15.9)	0.41 (10.4)	2.75 (69.6)	N/A
MA 64M ML 64M MC 64M	250-0302	N/A	M64x2	3.50 (88.9)	N/A	0.62 (15.9)	0.41 (10.4)	2.75 (69.6)	N/A

Stop Bars Inches (Millimeters)

Used with	Part #	S10	S11	S12	S13	S14	S15	S16
MA 33 ML 33 MC 33	250-0426	1.28 (32.5)	1.50 (38.1)	0.38 (9.7)	0.19 (4.8)	1.12 (28.4)	10-32 UNF	N/A
MA 33M ML 33M MC 33M	250-0427	1.28 (32.5)	1.50 (38.1)	0.38 (9.7)	0.19 (4.8)	1.12 (28.4)	M5x0.8	N/A
MA 36 ML 36 MC 36	250-0426	1.28 (32.5)	1.50 (38.1)	0.38 (9.7)	0.19 (4.8)	1.12 (28.4)	10-32 UNF	N/A
MA 36M ML 36M MC 36M	N/A	N/A	N/A	N/A	N/A	N/A	N/A	N/A
MA 45 ML 45 MC 45	250-0428	1.03 (26.2)	2.25 (57.2)	0.63 (16.0)	0.31 (7.9)	1.62 (41.3)	5/16-24 UNF	N/A
MA 45M ML 45M MC 45M	250-0639	1.03 (26.2)	2.25 (57.2)	0.63 (16.0)	0.31 (7.9)	1.62 (41.3)	M8x1.25	N/A
MA 6450 MA 64100 ML 6425 ML 6450 MC 6450 MC 64100	250-0430	1.44 (36.5)	3.50 (88.9)	0.50 (12.7)	0.25 (6.4)	2.75 (69.8)	3/8-24 UNF	1.37 (34.8)
MA 6450M MA 64100M ML 6425M ML 6450M MC 6450M MC 64100M	250-0640	1.44 (36.5)	3.50 (88.9)	0.50 (12.7)	0.25 (6.4)	2.75 (69.8)	M10x1.5	1.37 (34.8)
MA 64150 MC 64150	250-0432	2.31 (57.7)	3.50 (88.9)	0.50 (12.7)	0.25 (6.4)	2.75 (69.8)	3/8-24 UNF	1.37 (34.8)
MA 64150M MC 64150M	250-0641	2.31 (57.7)	3.50 (88.9)	0.50 (12.7)	0.25 (6.4)	2.75 (69.8)	M10x1.5	1.37 (34.8)
MAA 64150 MCA 64150	250-0435	2.18 (55.4)	3.50 (88.9)	0.50 (12.7)	0.25 (6.4)	2.75 (69.8)	3/8-24 UNF	1.37 (34.8)
MAA 64150M MCA 64150M	250-0649	2.18 (55.4)	3.50 (88.9)	0.50 (12.7)	0.25 (6.4)	2.75 (69.8)	M10x1.5	1.37 (34.8)

Square Flange

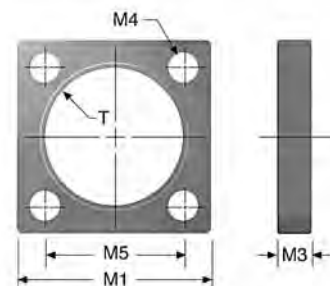

Rectangular Flange

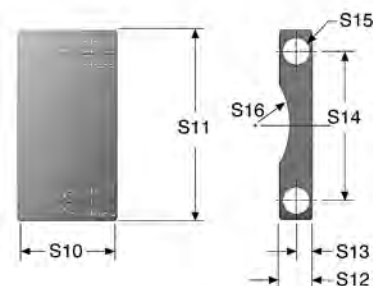
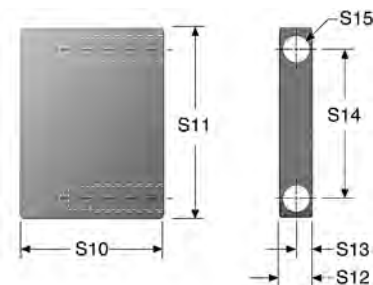
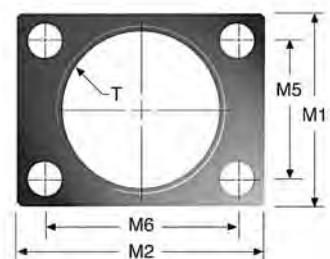

Hard metric stop bars available upon request.

Stop bars come in pairs, two bars per package.

Magnum Series Group Accessories

Flanged Stop Collars In Inches (Millimeters)

Used With	Part #	T	S1	S2	S3	S4	S5	S6	S7
MA 33 ML 33 MC 33	250-0070	1-1/4-12 UNF	2.00 (50.8)	1.50 (38.1)	2.50 (63.5)	2.00 (50.8)	0.88 (22.4)	0.25 (6.4)	0.282 (7.16)
MA 33M ML 33M MC 33M	250-0071	M33x1.5	2.00 (50.8)	1.50 (38.1)	2.50 (63.5)	2.00 (50.8)	0.88 (22.4)	0.25 (6.4)	0.282 (7.16)
MA 36 ML 36 MC 36 MA 36M ML 36M MC 36M	N/A	N/A	N/A	N/A	N/A	N/A	N/A	N/A	N/A
MA 45 ML 45 MC 45	250-0072	1-3/4-12 UN	1.85 (47.0)	2.25 (57.2)	3.25 (82.6)	2.75 (69.6)	0.88 (22.4)	0.25 (6.4)	0.282 (7.16)
MA 45M ML 45M MC 45M	250-0073	M45x1.5	1.85 (47.0)	2.25 (57.2)	3.25 (82.6)	2.75 (69.9)	0.88 (22.4)	0.25 (6.4)	0.282 (7.16)
MA 6450 MA 64100 ML 6425 ML 6450 MC 6450 MC 64100	250-0074	2-1/2-12 UN	2.25 (57.2)	3.00 (76.2)	4.25 (108.0)	3.50 (88.9)	1.00 (25.4)	0.38 (9.7)	0.282 (7.16)
MA 6450M MA 64100M ML 6425M ML 6450M MC 6450M MC 64100M	250-0075	M64x2	2.25 (57.2)	3.00 (76.2)	4.25 (108.0)	3.50 (88.9)	1.00 (25.4)	0.38 (9.7)	0.282 (7.16)
MA 64150 MC 64150	250-0076	2-1/2-12 UN	3.13 (79.4)	3.00 (76.2)	4.25 (108.0)	3.50 (88.9)	1.00 (25.4)	0.38 (9.7)	0.282 (7.16)
MA 64150M MC 64150M	250-0077	M64x2	3.13 (79.4)	3.00 (76.2)	4.25 (108.0)	3.50 (88.9)	1.00 (25.4)	0.38 (9.7)	0.282 (7.16)

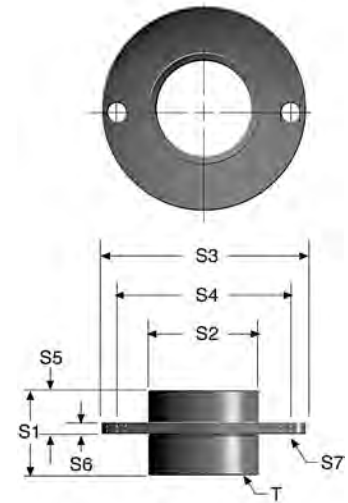

Lock Nuts Inches (Millimeters)

Used With	Part #	T	W	N3
MA 33 ML 33 MC 33	250-0038	1-1/4-12 UN	1.50 (38.1)	0.25 (6.4)
MA 33M ML 33M MC 33M	250-0292	M33x1.5	1.56 (39.6)	0.25 (6.4)
MA 36 ML 36 MC 36	250-0631	1-3/8-12 UNF	1.75 (44.5)	0.25 (6.4)
MA 36M ML 36M MC 36M	250-0537	M36x1.5	1.75 (44.5)	0.25 (6.4)
MA 45 ML 45 MC 45	250-0041	1-3/4-12 UN	2.25 (57.2)	0.37 (9.4)
MA 45M ML 45M MC 45M	250-0297	M45x1.5	2.25 (57.2)	0.37 (9.4)
MA 64 ML 64 MC 64	250-0042	2-1/2-12 UN	3.00 (76.2)	0.37 (9.4)
MA 64M ML 64M MC 64M	250-0302	M64x2	3.00 (76.2)	0.37 (9.4)

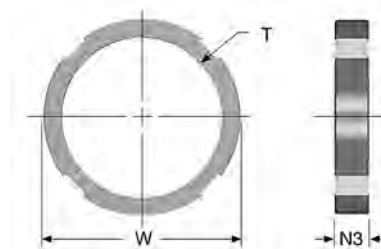

One lock nut included with each shock absorber where appropriate.

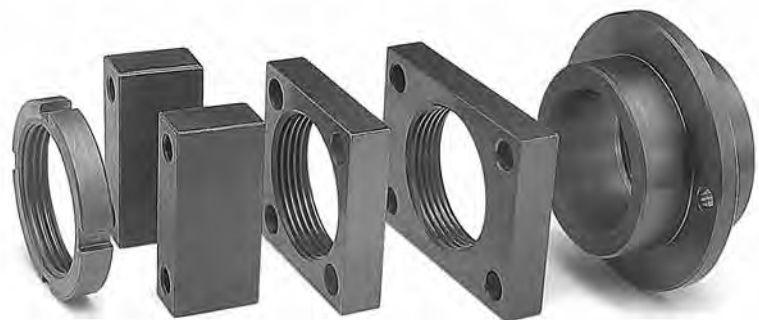

Side-Foot Mount Assembly



Side-Foot Mount Assembly

Used With	Part #	Used With	Part #
MA 33 ML 33 MC 33	250-0015	MA 6450 MA 64100 ML 6425	250-0300
MA 33M ML 33M MC 33M	250-0294	ML 6450 MC 6450 MC 64100	
MA 36 ML 36 MC 36	N/A	MA 6450M MA 64100M ML 6425M	250-0306
MA 36M ML 36M MC 36M	N/A	ML 6450M MC 6450M MC 64100M	
MA 45 ML 45 MC 45	250-0025	MA 64150 MC 64150	250-0030
MA 45M ML 45M MC 45M	250-0300	MA 64150M MC 64150M	250-0306

Clevis Mount Assembly



Clevis Mount Assembly

Used With	Part #	Used With	Part #
MA 33 ML 33 MC 33 MAS MLS MCS	250-0225	ML 6425 ML 6425M	250-0625 250-0626
MA 33M ML 33M MC 33M MAS 33M MLS 33M MCS 33M	250-0323	MA 6450 ML 6450 MC 6450	250-0625
		MA 6450M ML 6450M MC 6450M	250-0626
		MA 64100 MC 64100	250-0625
		MA 64100M MC 64100M	250-0626
MAN 33 MLN 33 MCN 33 MAA 33 MLA 33 MCA 33	250-0018	MAN 64150 MCN 64150 MAA 64150 MCA 64150	250-0625
		MAN 64150M MCN 64150M	250-0626
MAN 33M MLN 33M MCN 33M MAA 33M MLA 33M MCA 33M	250-0322	MAA 64150M MCA 64150M	
		MA 64150 MCA 64150 MAS 64150 MCS 64150	250-0627
MA 45 ML 45 MC 45	250-0324	MA 64150M MCA 64150M MAS 64150M MCS 64150M	250-0628
MA 45M ML 45M MC 45M	250-0325		

B

Shock Absorbers
 Actuator Products

Shock
 Absorbers