

# The PHM/PM User Guide



*July 2006*

*Parker-CTC Automation  
50 W. TechneCenter Drive, Milford, Ohio 45150*

*Part #: A3-06717-01*

anything  Possible.™

## Copyright and Trademark Notice

Copyright © 2006 by Parker-CTC Automation. All rights reserved. No part of this publication may be reproduced, transmitted, transcribed, stored in a retrieval system, in any form or by any means, mechanical, photocopying, recording or otherwise, without the prior written consent of Parker-CTC Automation.

While every precaution has been taken in the preparation of this manual, Parker-CTC Automation and the author assume no responsibility for errors or omissions. Neither is any liability assumed for damages resulting from the use of the information contained herein. All product and company names are trademarks of their respective companies and licenses.

The following products are copyright their respective owners: Microsoft, Microsoft Windows, Intel, SanDisk, SanDisk ImageMate, IBM, Lantastic, and Gunk.

## Product Warranty Information

Parker-CTC Automation provides top quality products through rigid testing and the highest quality control standards. However, should a problem occur with your hardware or with the software protection key, CTC's standard product warranty covers these items for 15 months from the date of shipment from CTC. Exceptions appear below:

- PowerStation backlight bulbs have a 90-day warranty.
- Third-party products, such as bus cards, carry the manufacturer's specified warranty.
- For all displays, image retention (burn-in) is not covered by warranty.
- Software revisions that occur within 60 days after purchase are available under warranty upon request. Please review the Interact License Agreement for additional software warranty information.

Should you have any questions about your application or need technical assistance, please call Parker-CTC Automation's Product Technical Support department at 513-248-1714, 8:00 a.m. to 5:00 p.m., Eastern Time. You may call this same number after hours for emergency assistance. See *Customer Support Services* on page 1-3 for more information about support products and services.

## Supported Monitor Models

This manual is for use with the following monitors:

- Model PHM 15" and 17" TFT Flat Panel Monitor
- Model PM 15" and 17" TFT Flat Panel Monitor

The PHM monitor contains the Hampshire touchscreen controller. The PM monitor contains the 3M/Dynapro touchscreen controller.

# Table of Contents

<b>1 Introduction</b>	<b>1-1</b>
Using this Manual	1-1
Documentation Library	1-1
Documentation Standards	1-2
Text Conventions	1-2
ISO Symbols	1-2
Customer Support Services	1-3
Product Technical Support	1-3
Technical Training	1-4
Getting Started	1-4
<b>2 Installing the Monitor</b>	<b>2-1</b>
Selecting a Location	2-1
Underwriters Laboratories Approval	2-1
Class I, Division 2 Guidelines	2-1
Environmental Guidelines	2-2
Touchscreen Considerations	2-2
Electrical Guidelines	2-3
Field Terminal Wiring Requirements	2-3
Temperature and Humidity Guidelines	2-4
Enclosure Guidelines	2-4
Accessing Ports and Other Controls	2-5
Radiated Emissions Guidelines	2-5
Mounting the Monitor in an Enclosure	2-6
Creating a Cutout	2-6
Mounting an External AC Adapter	2-6
Preparing the Power Connector	2-8
Mounting the Monitor	2-8
<b>3 Connecting to a Computer</b>	<b>3-1</b>
Connecting to a Non-display PowerStation	3-1
Connecting to Other Computers	3-2
Starting Up	3-2
To Start Up Your System	3-3
Setting Up the Monitor	3-4
Step1: Installing the Touchscreen Driver	3-4
Step 2: Calibrating the Touchscreen	3-5
Step 3: Adjusting the Video Image	3-5

<b>4</b>	<b>Maintaining the Monitor</b> .....	<b>4-1</b>
	Cleaning the Screen .....	4-1
	Recalibrating the Touchscreen .....	4-1
	Performing Internal Maintenance .....	4-2
	Electrostatic Discharge (ESD) Precautions .....	4-2
	Opening and Closing the Backshell .....	4-2
	Opening the Back Cover .....	4-3
	Closing the Backshell .....	4-4
	Replacing a Fuse .....	4-5
	Resolving Common Problems .....	4-6
	Problems with Display Operation .....	4-6
	Problems with the Displayed Image .....	4-7
<b>A</b>	<b>Monitor Specifications</b> .....	<b>A-1</b>
	Physical Specifications .....	A-1
	Display Specifications .....	A-1
	Environmental Specifications .....	A-2
	Electrical Specifications .....	A-3
	Testing Specifications .....	A-3
	Faceplate Chemical Resistance .....	A-4
	Touchscreen Cable Diagram .....	A-5
	Video Input Signals .....	A-6
<b>B</b>	<b>PM1 Monitor Installation</b> .....	<b>B-1</b>
	Connecting to a Non-display Computer .....	B-2
	Installing the Touchscreen Driver .....	B-2
	Calibrating the Touchscreen Driver .....	B-3

# LIST OF FIGURES

Figure 2-1 : Monitor Ports . . . . .	2-5
Figure 2-2 : Mounting an External AC Adapter . . . . .	2-7
Figure 2-3 : Power Connector . . . . .	2-8
Figure 2-4 : Mounting the Clamp Diagram . . . . .	2-9
Figure 3-1 : Communication Ports on the Monitor . . . . .	3-1
Figure 3-2 : Power and Ground Ports . . . . .	3-3
Figure 3-3 : On-Screen Display Menu . . . . .	3-6
Figure 4-1 : Removing the 17" Monitor Back Cover . . . . .	4-3
Figure 4-2 : Accessing the Internal Cables of the Monitor . . . . .	4-4
Figure 4-3 : Fuse Location on the Board . . . . .	4-5
Figure A-1: Touchscreen Cable Diagram . . . . .	A-5
Figure B-1: Communication Ports on the Monitor . . . . .	B-2

# LIST OF TABLES

Table A-1: Physical Specifications . . . . . A-1  
Table A-2: Display Specifications . . . . . A-1  
Table A-3: Environmental Specifications . . . . . A-2  
Table A-4: Electrical Specifications . . . . . A-3  
Table A-5: European Community Immunity and Emission Standards. . . . . A-3  
Table A-6: Mechanical Testing Specifications . . . . . A-4  
Table A-7: Faceplate Chemical Resistance Specifications . . . . . A-4  
Table A-8: Video Cable Specifications . . . . . A-6

# INTRODUCTION

Thank you for purchasing a Parker Hannifin monitor. You can mount the monitor in a control enclosure or on an adjustable arm. It can be used with any model of the PowerStation industrial computer family or with other computers that run Windows<sup>®</sup> operating systems.

This manual is for use with both the PHM monitor containing the Hampshire touchscreen controller, as well as the PM monitor containing the 3M/Dynapro touchscreen controller. If you have purchased a PM monitor with a 3M/Dynapro controller, use the installation instructions in *Appendix B: PM1 Monitor Installation* of this manual.

## Using this Manual

---

This manual is designed to help you set up and use your Parker Hannifin monitor and is divided into the following chapters:

**Chapter 1 - Introduction:** Presents an overview of this manual, any other documentation provided with the monitor, and how to contact customer support services.

**Chapter 2 - Installing the Monitor:** Explains how to select an appropriate location for the monitor and how to install the monitor in a control enclosure.

**Chapter 3 - Connecting to a Computer:** Explains how to connect and properly set up the monitor to a computer.

**Chapter 4 - Maintaining the Monitor:** Explains how to install replacement parts and how to maintain the monitor.

**Appendix A - Monitor Specifications:** Describes the monitor's specifications.

**Appendix B - PM Monitor Installation:** Describes the installation and setup of the PM1 monitors only.

## Documentation Library

---

The documentation set for this monitor contains:

**Release Notes** - This document is provided whenever there is important information about the monitor that does not appear in this manual. Be sure to read any available release notes before installing or operating the unit.

**PHM/PM User Guide** - This documentation contains all the information you need to configure, install and use the monitor.

You can download CTC product documentation from our web site at [www.ctcusa.com](http://www.ctcusa.com). Click on the *Support* link then select *Product Manuals* to find the appropriate manual.

## Documentation Standards



---

As you read this manual, notice that it uses the following documentation standards:

### Text Conventions

Style	Type of Text
<b>Bold</b>	Names of buttons, tabs, menus, menu items, commands, files, keyboard keys, dialog boxes and other important terms.
<i>Italic</i>	Titles of User Guides, chapters, or sections and cross-references.
Courier font	Text to be entered from a keyboard.
+	Indicates two or more keyboard keys that must be pressed simultaneously. For example, <b>Ctrl+Alt+Delete</b> .
<b>Note</b>	Alternative approaches or issues you should be aware of while using a particular function.
<b>Important</b>	Information that will save time and minimize problems.
<b>Warning</b>	Information that will prevent equipment damage or personal injury.

### ISO Symbols

Symbol	Meaning
	This symbol is the International Standards Organization (ISO) symbol for <b>Caution</b> (ISO 3864 No. B.3.1). This symbol denotes information that could affect operation of the monitor if the information is not properly followed.
	This symbol is the ISO symbol for <b>Caution - risk of electrical shock</b> (ISO 3864 No. B.3.6). This symbol denotes information that could cause personal injury from electrical shock or damage to equipment if the information is not properly followed.



## Customer Support Services

---

CTC welcomes your thoughts and suggestions on our products and services. You can contact CTC by telephone, email or fax. You can also visit CTC on the World Wide Web to learn the latest about our hardware, software and customer support services.

Customer Support	
Main Telephone	513-831-2340
Technical Support	513-248-1714
Fax	513-831-5042
E-mail	<b>Sales:</b> emn_sales_ctc@parker.com
	<b>Support:</b> emn_support_ctc@parker.com
	<b>Training:</b> emn_training_ctc@parker.com
World Wide Web	<a href="http://www.ctcusa.com">http://www.ctcusa.com</a>

CTC recognizes that every customer and every application has different support needs, so CTC offers a variety of support services designed to meet these needs. CTC offers two types of customer support services:

- Product Technical Support
- Technical Training

### Product Technical Support

The Product Technical Support department welcomes any questions that might arise as you develop or run your applications. We offer complimentary support for all customers, including end users, original equipment manufacturers (OEM), system integrators or distributors.

If you have a question about the monitor, be sure to complete the following steps:

- Check any release notes that shipped with the unit. These notes provide important information about the monitor.
- Consult the documentation and other printed materials included with the monitor.
- Review *Chapter 4, Maintaining the Monitor*.
- Visit the CTC Web site and register for the support forum. You can find the support forum by clicking on the *Support* tab from the Web site's home page: <http://www.ctcusa.com>.

If you cannot find a solution using one of the above sources, contact our Product Technical Support department at 513.248.1714, 8:00am to 5:00pm Eastern Standard time.

## Technical Training

CTC offers training on all of our products, either at CTC in our state-of-the-art training facility, or at your site.

You can contact the Training Coordinator by telephone or e-mail:

- Telephone: 1-800-233-3329
- E-mail CTC Training: [emn\\_training\\_ctc@parker.com](mailto:emn_training_ctc@parker.com)

You can view a current training schedule on our web site at [www.ctcusa.com](http://www.ctcusa.com).

## Getting Started

---

Now that you have opened the monitor package, you are ready to unpack the unit and install it in a permanent location. Follow the steps below to get started.

- 1 Unpack the monitor and verify that you have received all of the components you ordered.
- 2 Install the monitor in a permanent location. See Chapter 2, *Installing the Monitor*, for complete installation instructions.
- 3 Connect the monitor to a computer—either to a PowerStation or another computer supporting an analog video output connector. See Chapter 3, *Connecting to a Computer* for more information
- 4 Start up your system and follow the detailed instructions for setting up the monitor described in *Setting Up the Monitor* on page 3-4.

# INSTALLING THE MONITOR

You can install the monitor by mounting it in a control enclosure or on an adjustable arm. This chapter explains how to select an appropriate location for the monitor and how to mount it in an enclosure.

If you are mounting the monitor on an adjustable arm, refer to the documentation that accompanies the arm for installation instructions.

## Selecting a Location

---

The first step when installing the monitor is to select an appropriate location for the unit. This is the most important aspect of the installation process because the location you select affects the monitor's performance, ease of use and life-expectancy. This section provides guidelines to follow when selecting a location.

## Underwriters Laboratories Approval

In order to obtain Underwriters Laboratories (UL) approval for your monitor installation, the installation must meet the following criteria:

- 1 The monitor must be mounted in a standard industrial enclosure that provides fire protection.
- 2 The monitor must be mounted in an enclosure that meets a Type 4 rating.

## Class I, Division 2 Guidelines

If you purchased a Class I, Division 2-compliant monitor, it is suitable for use in Groups A, B, C, and D hazardous locations *only*. You must follow these guidelines in order to maintain a safe operating environment.



**Warning**    **Explosion Hazard** — Do not disconnect equipment, replace or insert cards unless the power has been switched off, or the area is known to be safe.

Substitution of components may impair suitability for Class I, Division 2.

## Environmental Guidelines

The environment is the area where the monitor is located. In general, select a place that limits the unit's exposure to adverse conditions such as dust, oil, moisture, condensation and corrosive vapors.

### Touchscreen Considerations

The monitor's touchscreen is designed to meet the Type 4 rating. Mount the monitor in an enclosure that supports this rating in order to provide further protection.

The monitor's touchscreen is resistant to a variety of chemicals. It can resist the chemicals listed below with no visible effect.

Screen Chemical Resistance		
Properties	HA210	Test Methods
cosmetics	OK	naked eye
total thickness (gauge)	710	micrometer
pencil hardness	3H	JIS 5400
adhesion	100/100	1mm - 100 grid cross hatch/snap tape test
steel wool	pass	rub
VLT(%)	92.2	BYK Gardner Hazegard Plus
haze	8.63	BYK Gardner Hazegard Plus
clarity	76.5	BYK Gardner Hazegard Plus
gloss	108	BYK Gardner Hazegard Plus
L*	94.9	Hunterlab colorimeter
a*	-0.12	Hunterlab colorimeter
b*	1.10	Hunterlab colorimeter
chemical resistance in Acetic Acid	pass	ambient temp/24 hours
chemical resistance in 5% NaOH	pass	ambient temp/24 hours
chemical resistance in 35% HCl	pass	ambient temp/3 hours
solvent resistance to Benzene	pass	ambient temp/0.5 hours
solvent resistance to Toluene	pass	ambient temp/24 hours
solvent resistance to Ethanol	pass	ambient temp/24 hours
solvent resistance to Acetone	pass	ambient temp/24 hours
solvent resistance to Ethyl Acetate	pass	ambient temp/24 hours

Make sure that the touchscreen is not exposed to chemicals other than those listed in the table above.

**Important** The system is only rated Type 4 when it is installed in a UL listed Type 4X enclosure.

## Electrical Guidelines

To minimize unwanted electrical interference, select a location away from machinery that produces intense electrical noise (arc welders, for example). If you cannot avoid electrical noise, isolate input power to the unit and separate all data communication cables from AC power lines.

**Important** Use the monitor ground stud to connect the unit to a suitable ground reference, such as earth ground or building steel. This ensures the unit is in compliance with immunity and emissions requirements necessary for proper operation.

All serial communication cables should be 100% shielded with the shield tied to chassis ground only at one end of the cable.

The monitor's electrical specifications are shown in the table below.

Category	Specifications
Input voltage	24 VDC @ 2A max
Power requirements	48 Watts maximum
Fuse rating	4A (very fast-acting type)

Make sure that your power source is compatible with the monitor before starting the unit.

The monitor accepts DC input only. To apply AC power, you must use an AC adapter. You can purchase an AC adapter from your local distributor.



**Caution:** The monitor's power supply automatically detects the input voltage level and adjusts accordingly. However, always use reliable sources of power and isolate all communication cables from AC power lines to enhance noise immunity.

### Field Terminal Wiring Requirements

In order to comply with UL requirements, use copper wire with 60C or 60/75C insulation and a tightening torque of 7.0 lb/in. (0.79 N-m) when connecting field terminal wiring to the monitor.

## Temperature and Humidity Guidelines

You can safely operate the monitor within the temperature range specified in the table below.

Category	Specifications
Operating temperature	32° to 122°F (0° to 50°C) ambient (air temperature outside of backshell)
Storage temperature	-13° to 185°F (-25° to 85°C)
Relative humidity	95% @ Ta < or = 104°F (40°C) non-condensing
Shock rating	<ul style="list-style-type: none"> <li>• Operating — 10g 11ms pulse</li> <li>• Non-operating — 30g 11ms pulse</li> </ul>
Operating vibration	5–500 Hz 1 grms
Faceplate Design	Tested for UL Type 4/4X environment  <b>Warning:</b> The monitor is rated NEMA 4 only if it is installed in a NEMA 4 rated enclosure.

**Important:** Limit the monitor's exposure to adverse conditions, such as dust, oil, moisture, and corrosive vapors in order to minimize maintenance and repair costs.

Be sure to choose an area for the monitor that is free from moisture or condensing humidity.

## Enclosure Guidelines

Select an enclosure that is large enough to allow free airflow in and around the monitor.



**Caution:** Remember that the temperature within a protective enclosure is generally higher than the external temperature. Thus, if the monitor is operating inside an enclosure at temperature levels above its rated ambient temperature, you must cool the enclosure.

You should allow a minimum of 2 inches between the inside of the enclosure and the top, bottom, sides, and back of the monitor. Make sure that the surface where the unit meets the front panel of the enclosure is flat in order to ensure a Type type 4 seal.

Refer to the CD that came with your monitor for dimensional drawings.

## Accessing Ports and Other Controls

As shown in Figure 2-1, a +24VDC power input port, touchscreen port, analog video input port and the on-screen display controls (OSD) are located on the left side of the unit in all models of the monitor. Be sure to design your enclosure with these locations in mind.

**Figure 2-1: Monitor Ports**

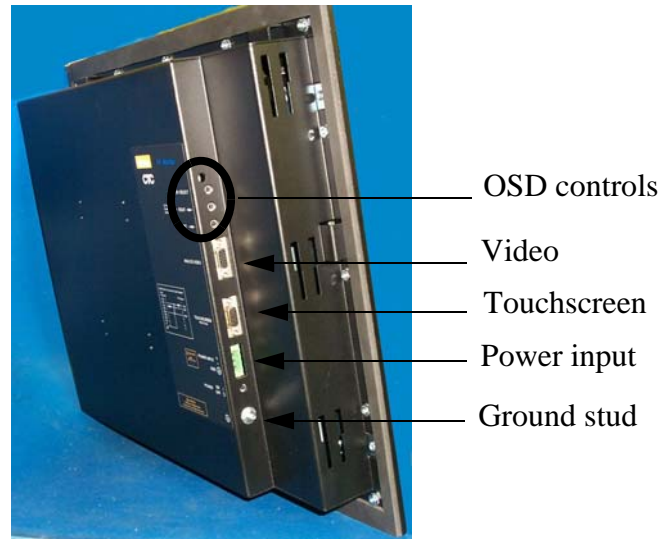

**Important** To be compliant with CE EMC emission requirements under EN55011, all video, serial, and parallel port communication cables must be 100% braided shielded cable.

## Radiated Emissions Guidelines

This monitor has been tested to comply with international electromagnetic and emission standards. To reduce radiated emissions, ensure that there is a good earth connection to the monitor, you can do this by using the grounding stud located on the left-side of the chassis. Use the shortest possible, heavy gage wire or braided cable to make this connection.

Verify low-resistance (<0.5 ohms) continuity with an ohmmeter for proper grounding. In addition, be sure all communication cables are shielded and grounded only on one side.

## Mounting the Monitor in an Enclosure

Read this section if you intend to mount the monitor in an enclosure. If you plan to mount the monitor on an adjustable arm, see the documentation that accompanies the arm for installation instructions.

### Creating a Cutout

When mounting the monitor in an enclosure, you first need to create a cutout for the unit and clean the area of any dirt or debris that might come in contact with the monitor.

- 1 Measure the cutout dimensions as shown in the table below.

Monitor Size	Cutout Height	Cutout Width
15" (stainless steel bezel)	12.40" (315mm)	15.90" (404mm)
15" (standard bezel)	12.40" (315mm)	15.90" (404mm)
17" (standard bezel)	14.26" (362mm)	17.06" (433mm)

- 2 Cut out the marked area. The cutout dimensions depend upon the size of your monitor. To maintain the flatness of the mounting surface, it is recommended that you punch out the mounting hole, as you should maintain proper surface flatness and edge quality.

Refer to the CD that comes with the monitor for the depth and port dimensions of your monitor. Use these dimensions to customize the mounting of your unit.

**Important** If using an external AC adapter, remember to take the adapter's dimensions into account when planning the depth of the monitor enclosure.

- 3 Debur the edges of the cutout area, removing dirt and debris that might come in contact with the unit.

### Mounting an External AC Adapter

The monitor uses DC power. You can however, operate the monitor using AC power by ordering an optional external AC adapter.

The External AC Power Supply Adapter (P1X-PWRAC) is available from Parker-CTC, along with an installation kit (BKT-1000) that allows you to mount the adapter either on the back of the monitor or near it.



**Caution** Do not apply AC power to the unit without the AC adapter or damage may occur.



To mount the adapter on the back of the monitor:

- 1 Place the monitor face-down on a static dissipative mat in a location free from dirt and moisture and protected against static discharge.
- 2 Place the external AC adapter between the four mounting holes in the center, as shown in Figure 2-2 : *Mounting an External AC Adapter*. Make sure that the adapter's DC connection is toward the top of the monitor and that the AC connection is toward the bottom.
- 3 Place the two adapter mounting clamps over the top and bottom of the adapter, as shown in the illustration. Align the holes in the clamps with the mounting holes in the back of the monitor. Notice that the lower mounting clamp has a special extension that reaches down over the AC connection and holds it in place.
- 4 Fasten the adapter to the monitor with the four retaining screws included in the adapter installation kit. The completed installation should look like the illustration below.

**Figure 2-2: Mounting an External AC Adapter**



For instructions on how to mount the external AC adapter near the monitor, see the documentation that accompanies the adapter installation kit.

## Preparing the Power Connector

Prepare the power source for the unit by sliding the positive and negative wires into the appropriate slots on the power connector as shown in Figure 2-3 : *Power Connector*.

**Figure 2-3: Power Connector**

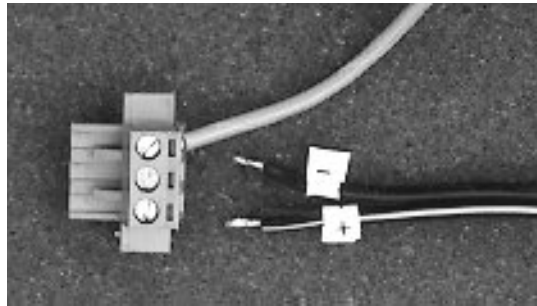

Connect the ground cable from the power connector to an earth ground.

## Mounting the Monitor

There are two styles of clamps used to mount the monitor to your enclosure depending on the display size. Both styles are illustrated in Figure 2-4 : *Mounting the Clamp Diagram* below. When mounting the monitor, note that the 15" monitor uses 8 clamps to mount in its enclosure, while the 17" monitor uses 12 clamps.

To mount the monitor:

- 1 Slide the monitor into the cutout from the front.
- 2 Attach the mounting clamps, with their screws, to the back of the unit in the spaces provided.
  - If you have a 15" monitor, attach 8 mounting clamps, with their screws, to the back of the monitor in the spaces provided. Place 2 clamps at the top and bottom of the monitor and 2 on each side.
  - If you have a 17" monitor, attach 12 mounting clamps, with their screws, to the back of the monitor in the spaces provided. Place 3 clamps at the top and bottom of the monitor and 3 on each side.

The clamps secure to the unit using CTC's sliding mechanism. Insert the clamp into the wide end of the slot and slide it to the thin end. See Figure 2-4 : *Mounting the Clamp Diagram* on page 2-9.

Figure 2-4: Mounting the Clamp Diagram

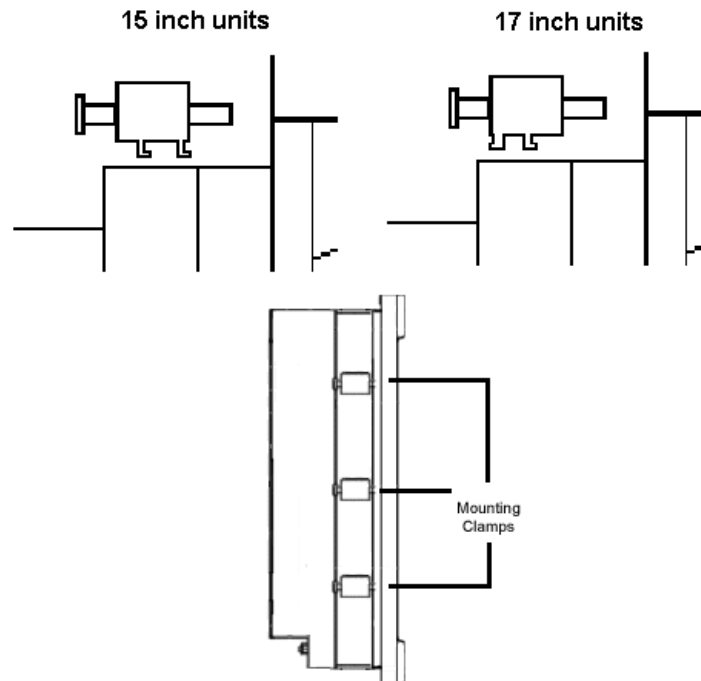

- 3 Slide the feet of the mounting clip into the slot, then slide the clip over to properly mount the unit.
- 4 Tighten each of the mounting screws against the front of the enclosure.
- 5 Torque the screws to **7 in/lbs.**



**Caution:** Do not over-tighten the screw/clamp assemblies or you may damage the monitor. However, under-tightening may not guarantee a Type 4 seal.

- 6 Tighten the screws in a crosswise sequence to ensure a good seal and prevent damage. Tightening the bracket assembly may not ensure that the gasket seal is totally depressed by the bezel. You may see a small gap between the bezel and the enclosure.

After you have mounted the monitor, you are ready to connect the monitor to a computer, start up your system, and if necessary, set up the monitor. Instructions for these activities are described in Chapter 3, *Connecting to a Computer*.

## CONNECTING TO A COMPUTER

The monitor is designed to be used with a computer—either a PowerStation or another computer running MS-DOS or Windows 98, NT 4.0, Embedded NT, 2000, or XP. If you purchased a PowerStation with your monitor, your complete PowerStation system is set up and ready for you to use once you connect the components.

However, if you are connecting your monitor to another computer, you need to complete the setup procedures described in this chapter, including: how to connect the monitor to your computer, how to prepare the monitor to work with your computer, and how to read and adjust the on-screen display (OSD).

### Connecting to a Non-display PowerStation

---

To connect your monitor to one of the non-display PowerStations, complete the following steps:

- 1 Connect the 15-pin video cable to the Analog Video Input port on both the monitor and the non-display PowerStation, see Figure 3-1.
- 2 Connect the 9-pin touchscreen cable to the Touchscreen port on the monitor and to the COM2(B) communication port.

**Figure 3-1: Communication Ports on the Monitor**

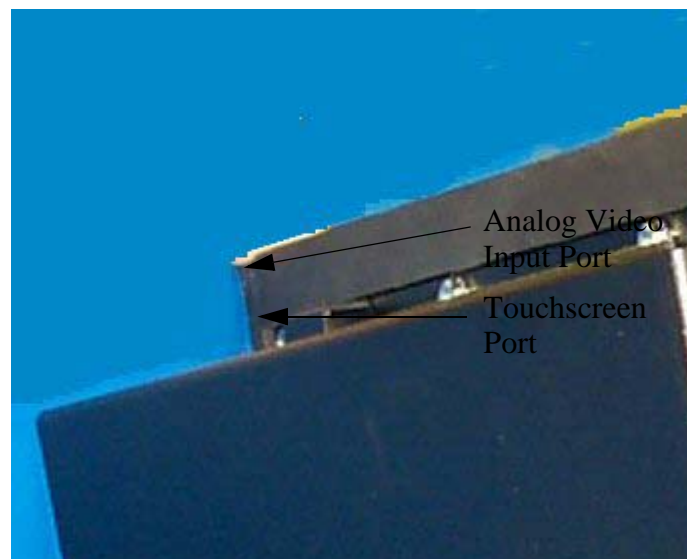

## Connecting to Other Computers

---

To connect your monitor to a generic computer running MS-DOS or Windows, complete the following steps:

- 1 Connect the 15-pin video cable to the Analog Video Input port at the left side of the monitor and to the 15-pin video port on your computer, see Figure 3-1 : *Communication Ports on the Monitor* on page 3-1.
- 2 Connect the 9-pin touchscreen cable to the Touchscreen port on the monitor and to the 9-pin serial port on your computer to use for touchscreen communications.

## Starting Up

---

Once you have connected your monitor to the non-display PowerStation or to another computer, you are ready to start your system.

However, before connecting power to your unit, make sure that you have read and understood the electrical and testing specifications described in Appendix A, *Monitor Specifications*. Also, make sure that you follow the guidelines listed below:

- **For permanently connected equipment**, a readily accessible disconnect device must be incorporated in the fixed wiring.
- **For pluggable equipment**, the socket-outlet must be installed near the equipment and should be easily accessible.

**Important** Proper installation of the monitor for use in European Union countries requires the use of a harmonized power cord. (The power cord must be identified with the <HAR> symbol.) Make sure that the monitor is only connected to the main supply with a harmonized power cord.

### To Start Up Your System

- 1 Connect the power cord to the Power Input port on the left side of the monitor and to the voltage source (see Figure 3-2).



**Warning** Voltage input to the unit should be within the range specified in *Electrical Specifications* in Appendix A.

**Figure 3-2: Power and Ground Ports**

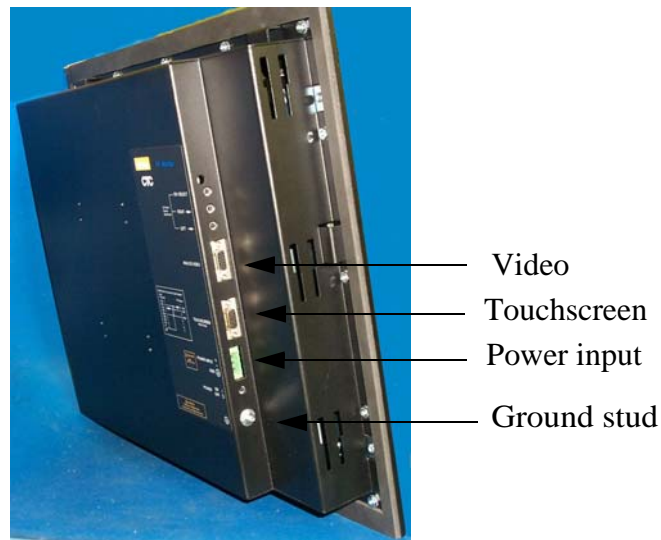

- 2 Connect the ground stud on the lower left side of the monitor to an effective, known earth ground (see Figure 3-2).
- 3 Connect your computer to a power source.
- 4 Turn on the computer.
- 5 Turn on the monitor.

## Setting Up the Monitor

---

If you connect the monitor to a non-display PowerStation, your system should now be completely installed and functioning. The monitor and PowerStation are already configured with the proper settings. Refer to this section only if you need to make adjustments to your monitor in the future.

If you connect the monitor to a generic computer, you need to complete the following steps so that the monitor works with your computer.

- *Step 1: Installing the Touchscreen Driver*
- *Step 2: Calibrating the Touchscreen*
- *Step 3: Adjusting the Video Image*

### Step 1: Installing the Touchscreen Driver

If you purchased a CTC non-display PowerStation with your monitor, a touchscreen driver was installed in your PowerStation before it shipped.

If you are using your monitor with another computer, or if your system becomes damaged, you need to install (or reinstall) the touchscreen driver.

To install the touchscreen driver, use the product CD that came with the monitor.

- 1 Load the CD. The PHM/PM Monitor Utility CD menu is displayed.
- 2 Click on **Drivers** from the menu on the left-hand side of the screen. The Drivers menu is displayed.
- 3 Click on **PHM Monitor Drivers**. The TSHARC driver installation is launched.
- 4 Follow the online instructions to install the touchscreen driver.

The touchscreen driver used with the monitor is the Hampshire TSHARC driver. This driver is located on the CD that shipped with your monitor in the following folder:

*Drivers → Touch → PHM*

This driver is also located on the OS image in the following directory:

C:\TSHARC

Review the *Install Readme.txt* file associated with the touchscreen driver for more information on installing it, if necessary.

## Step 2: Calibrating the Touchscreen

Calibrating the touchscreen ensures that it is aligned with your display. The monitor's touchscreen is calibrated before leaving Parker-CTC. However, you may need to recalibrate the touchscreen when you begin using the monitor for the first time or whenever the cursor does not follow the touches on the screen.

This section explains how to calibrate the Hampshire touchscreen driver under Windows 2000 and XP Professional.

To calibrate the touchscreen driver, complete the following steps:

- 1 Select **Start→Programs→Hampshire TSHARC Control Panel**. The control panel appears.
- 2 Follow the on screen instructions for selecting which monitor to calibrate. If you just have one monitor, select **1**.
- 3 Select the **Calibrate** tab.
- 4 Click the center of where the arrows are pointing. The Calibration screen appears.
- 5 Touch the target where it appears on the screen, hold your finger there momentarily, and then release. The screen guides you through the Touch - Hold - Release process.
- 6 Repeat the process three more times in the other three corners of the screen. A test screen appears.
- 7 Move your finger across the monitor. The target should move with your finger. If so, the calibration was successful.
- 8 Select **Accept**.
- 9 On the control panel, select **Apply** and then select **OK**.

**Note** If the touchscreen still does not appear calibrated, and the cursor moves vertically when your finger moves horizontally on the screen or vice versa, the touchscreen cable may not be connected to the motherboard properly. Call a CTC customer service representative.

## Step 3: Adjusting the Video Image

The monitor is equipped with an on screen display (OSD) that allows you to adjust the video image for the best possible picture.

By default, the OSD is set to Auto which automatically adjusts all OSD settings to their optimum values. However, you can manually make adjustments by using the three buttons at the upper left side of the monitor.



The buttons work as follows:

- **MENU/SELECT** — Switches the OSD on and off. When a particular setting is highlighted that you want to adjust, press this button again to select the submenu. In most cases, this displays a control bar showing the increase or decrease in adjustment.
- **RIGHT** — Functions like an arrow key on a keyboard, enabling you to progress through the OSD icons in order to select the setting you want to adjust. Once you have selected a setting, this button enables you to increase the value of the adjustment.
- **LEFT** — Functions like an arrow key on a keyboard, enabling you to reverse through the OSD icons in order to select the setting you want to adjust. Once you have selected a setting, this button enables you to decrease the value of the adjustment.

The first time that you change the monitor's resolution, it attempts to automatically adjust the settings. You may see a slight shifting of the video image as the monitor finds the optimal settings. Once the new resolution is set up, the monitor remembers these settings and uses them each time that resolution is chosen.

When you press the Menu/Select button, a menu similar to Figure 3-3, is displayed. This figure shows the Auto Setup icon selected.

**Figure 3-3: On-Screen Display Menu**

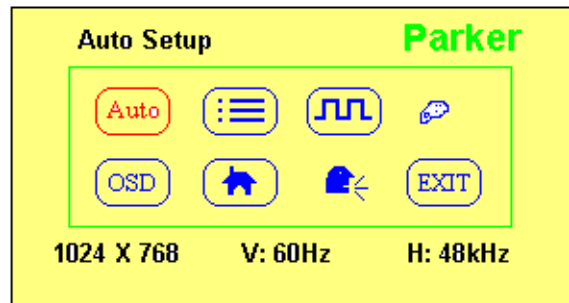

The following settings are available based on the selection in the OSD menu.

Feature	Description
Auto Setup	Automatically adjusts all OSD settings to their optimum values as determined from your computer. Each computer the monitor is connected to will have slightly different settings.
Management	Available selections: <ul style="list-style-type: none"> <li>• Brightness</li> <li>• Contrast</li> <li>• Display Horizontal Position</li> <li>• Display Vertical Position</li> </ul>

Feature	Description
Clock/Phase	Available selections: <ul style="list-style-type: none"> <li>• Clock - enables setting of the horizontal size of the display.</li> <li>• Phase - enables setting of the sharpness of the display.</li> </ul>
Color	Available selections: <ul style="list-style-type: none"> <li>• Color Temp - select either Cool, Neutral, or Warm</li> <li>• Black Level Adjust - brightness controls for individual colors.</li> <li>• RGB Adjust - intensity of RGB colors.</li> </ul>
OSD Display	Allows moving the OSD menu around the screen: <ul style="list-style-type: none"> <li>• H. Position - select to move the OSD menu horizontally.</li> <li>• V. Position - select to move the OSD menu vertically.</li> </ul>
Factory Recall	Sets the display to the default settings of a typical video display. These settings may not be optimum for your particular monitor.
Language	Allows setting the language displayed on the OSD menus. Available languages are: <ul style="list-style-type: none"> <li>• English (default)</li> <li>• French</li> <li>• German</li> <li>• Italian</li> <li>• Spanish</li> </ul>
Exit	Select to exit the OSD menu.

To adjust the video image on your monitor, complete the following steps:

- 1 Press the **MENU/SELECT** button to display the OSD.
- 2 Use the **RIGHT/LEFT** buttons to choose the icon for the adjustment you want to make.
- 3 Press the **MENU/SELECT** button to activate the adjustment you want to make.

In most settings you are presented with a control bar for making your adjustment. Use the **RIGHT/LEFT** buttons to move the control bar to the desired value.

In other settings you simply select the option then use the **MENU/SELECT** button to configure the option.

The results of your changes are immediately visible. The monitor remembers all OSD adjustments so that you do not need to repeat them each time you turn on the monitor.

**Note** If the OSD is turned on and then left unattended, it automatically shuts off in 15 seconds.

# MAINTAINING THE MONITOR

The monitor has been designed to provide years of trouble-free operation even in the harshest environments. However, occasionally you need to perform routine maintenance on some of the monitor's components.

This chapter provides instructions on monitor maintenance, as well as steps for troubleshooting problems that may occur in operation.

## Cleaning the Screen

---

Occasionally, you may need to clean the monitor's screen. Clean the screen using warm, soapy water and a cloth. You can also use any non-abrasive cleaner. See *Faceplate Chemical Resistance* on page A-4, for a list of substances the screen can resist with no visible effect.

Do not use any harsh material or powder, such as steel wool or abrasive cleansers, to clean the screen surface. The surface is sensitive to scraping, sharp blows, or punctures. Therefore, keep screwdrivers or other sharp objects away from the screen surface.



**Warning** Do **not** clean the unit while it is running. Turn off the monitor before cleaning it in order to avoid inadvertently activating the touchscreen.

## Recalibrating the Touchscreen

---

Your touchscreen was calibrated by Parker CTC before your monitor was shipped. However, you may need to recalibrate the touchscreen when you begin using the monitor for the first time, when you connect the monitor to a new computer, or whenever the cursor location and the place on the screen where the user touches do not match. See *Step 2: Calibrating the Touchscreen* in Chapter 3, for instructions on how to recalibrate your touchscreen.

## Performing Internal Maintenance

---

The only internal maintenance necessary is replacing the fuse. To prevent injury to yourself and/or damage to the monitor, be sure to read and understand the procedures in this section before performing them.

This section discusses the following:

- Electrostatic Discharge Precautions
- Opening and closing the backshell
- Replacing a fuse

### Electrostatic Discharge (ESD) Precautions



Modern integrated electronic devices, including the monitor, are extremely sensitive to electrostatic discharges (ESD) and fields. Before you open the system, be sure to follow these simple precautions to protect you and the monitor from harm resulting from ESD.

- Always disconnect power from the monitor before opening or removing the backshell. **Do not** touch any components of the monitor while the monitor is on.
- Disconnect power before performing any internal maintenance or troubleshooting.
- Only handle internal components of the monitor in an ESD-safe location, using appropriate grounding methods.
- Wear a grounding wrist strap for continuous protection.
- Always ground yourself to remove any static charge before you touch the video controller board inside the monitor's backshell.
- Be particularly careful not to touch the components on the video controller board.
- Keep any monitor part in its anti-static packaging when it is not installed in the monitor and place it on a static dissipative mat when you are working on it.

### Opening and Closing the Backshell

In order to perform internal maintenance on the monitor, you have to open and close the backshell of the unit. ***For safety reasons, the monitor should be opened only by qualified service personnel.***

## Opening the Back Cover

To open the back cover, follow the steps below.

- 1 Turn off the computer to which the monitor is connected.
- 2 Turn off the monitor.
- 3 Unplug the monitor from its power source.
- 4 Disconnect the cables attached to the left side of the monitor:
  - Power Input cable
  - Touchscreen cable
  - Analog Video Input cable
  - Ground cable
- 5 Remove the monitor from its enclosure or arm.
- 6 Place the monitor face down on a static dissipative mat in a location free from dirt and moisture and protected against static discharge.
- 7 Remove the retaining nuts that secure the back cover, as shown in Figure 4-1. There are 12 retaining screws on 15" units and 16 retaining nuts on 17" units.

**Figure 4-1: Removing the 17" Monitor Back Cover**

**Figure 4-1a: Retaining Nuts**



Retaining nuts (16)

**Figure 4-1b: Tilt Angle**



- 8 Slowly tilt the back cover just enough to gain access to the internal cables that connect to it.

**Important:** Be careful not to lift the back cover too quickly and accidentally pull the cables off of the board.



- 9 Disconnect the touchscreen, display and inverter board cables from their connectors as shown in Figure 4-2. Be sure to disconnect the cables from the end located on the backshell board.

**Figure 4-2: Accessing the Internal Cables of the Monitor**

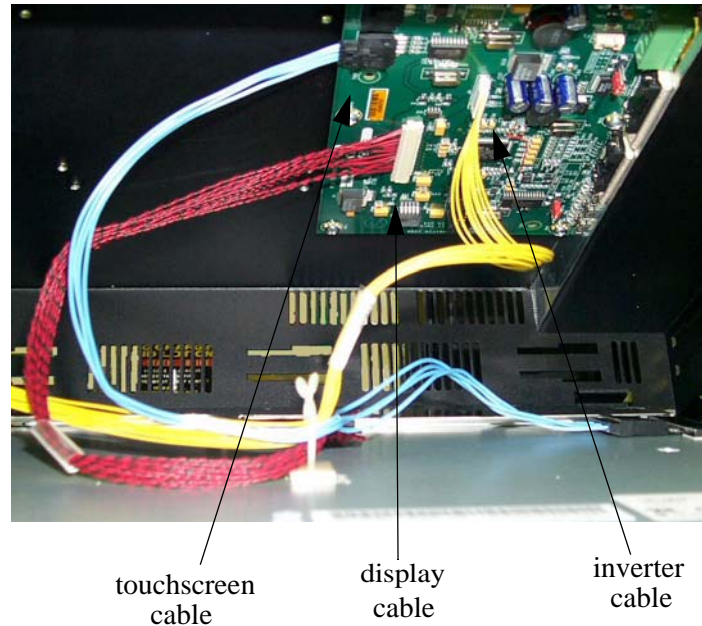

- 10 Once the cables are disconnected, gently lift the backshell off the unit.
- 11 Proceed to the specific maintenance or troubleshooting procedures you need to perform.

### Closing the Backshell

- 1 Carefully connect the touchscreen, display and inverter board cables to their respective connectors (see Figure 4-2). Be sure you orient the cables so that you do not bend their pins.
- 2 Secure the backshell to the unit using the retaining screws or nuts removed earlier. There are 12 retaining screws on 15" units and 16 retaining nuts on 17" units.
- 3 Reinstall the unit in its enclosure or on its arm.
- 4 Reattach the power input cable, touchscreen cable, video input cable and the ground cable at the left side of the monitor.
- 5 Reconnect the monitor to a power source.
- 6 Turn on the computer and the monitor.

## Replacing a Fuse

The monitor has a protective fuse that you can replace by opening up the backshell. An ohm meter is required to see whether the fuse is open or closed.

To replace the fuse, complete the following steps:

- 1 Open the backshell of the monitor (see the instructions for *Opening the Back Cover* on page 4-3).
- 2 Locate the fuse on the board according to Figure 4-3, below.

**Figure 4-3: Fuse Location on the Board**

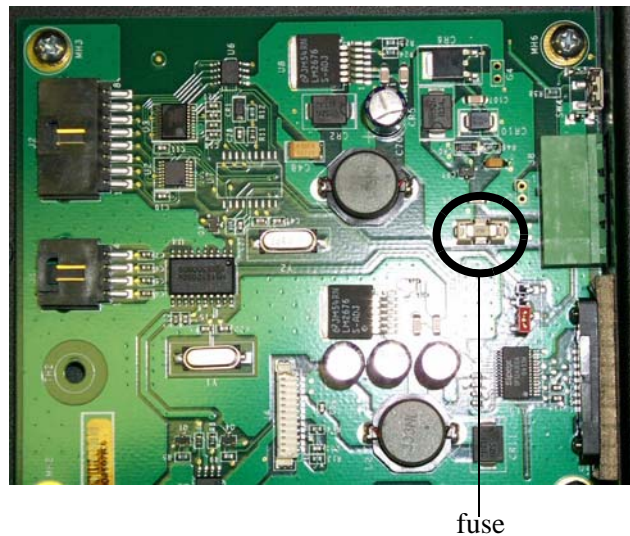

- 3 Use an ohm meter to see if the fuse is open or closed.
  - If open, use a pair of needlenose pliers to lift the fuse from the fuse holder.
  - If closed, the fuse is okay and there is no need to replace it.
- 4 To replace the fuse, use a Littlefuse Nano SMF Very Fast-Acting Type fuse. The part number is **R451 004**. This is a 4 amp fuse.



**Caution** Using a fuse that is rated differently than indicated here can cause damage or fire to occur.

- 5 Insert the new fuse into the fuse holder and reassemble the unit.
- 6 Close the backshell of the monitor (see the instructions for *Closing the Backshell* on page 4-4).

## Resolving Common Problems

This section provides some basic troubleshooting procedures to help identify and correct problems you may have with the monitor. Each problem is described, followed by one or more possible solutions. Begin with the first solution and continue until you have solved the problem or tried all of the solutions.

If you cannot solve the problem yourself, or if you encounter a problem that is not documented in this section, contact your Parker-CTC distributor, check the Support page on the CTC website [www.ctcusa.com](http://www.ctcusa.com), or call our Technical Support department at 513-248-1714.

Use the table below to find discussions of specific problems.

Problems with Display Operation	Page
Computer is on, the video cable is connected, but the screen is blank	4-6
The touchscreen does not work properly, or calibration seems incorrect (touchscreen monitors only)	4-7
After calibrating the touchscreen, it does not work or follow your finger (touchscreen monitors only)	4-7
Problems with the Displayed Image	Page
Image does not fill the screen	4-7
Image extends beyond the screen	4-7
Characters shimmer or appear fuzzy	4-8
When video mode is changed, the image shifts left or right	4-8
When video mode is changed, the image shifts up or down	4-8
Vertical bands appear in the image	4-8
Image appears faded or "washed out"	4-8

### Problems with Display Operation

A number of circumstances can cause problems in display operation. Here are some common problems and their solutions.

#### Computer is on, the video cable is connected, but the screen is blank.

- 1 The PC may be in screen saver mode or video "low power" mode. Touch the touchscreen (be careful not to activate a tool within your HMI software), move the mouse, or press a keyboard key to restore the image.
- 2 The monitor fuse has blown. Replace the fuse (see the instructions for *Replacing a Fuse* on page 4-5).



**Caution** If the monitor is exposed to a power supply voltage over 30VDC, its built-in protection will blow the fuse. In this case, you must correct the cause of the over-voltage.



### The touchscreen does not work properly, or calibration seems incorrect.

- 1 The computer wasn't restarted after installing the touchscreen drivers or after adjusting the touchscreen settings. Restart the computer.
- 2 Touchscreen calibration might be in error. Recalibrate the touchscreen (see *Step 2: Calibrating the Touchscreen* in Chapter 3, for details).
- 3 The touchscreen drivers may have been installed incorrectly. Go to *Step 1: Installing the Touchscreen Driver* on page 3-4, for help reinstalling the driver. Refer to the *Readme* file located in the C:\drivers\touch directory.

### After calibrating the touchscreen, it does not work or follow your finger.

- 1 The touchscreen cable may be loose or improperly connected. Make sure that the touchscreen cable is properly connected.
- 2 The touchscreen cable may be damaged. Contact Parker-CTC Product Technical Support at 513-248-1714 about having the cable replaced.
- 3 The touchscreen may be damaged. Contact Parker-CTC Product Technical Support at 513-248-1714 about having the touchscreen replaced.
- 4 Cables or wiring inside the monitor may be damaged. Contact Parker-CTC Product Technical Support at 513-248-1714.

## Problems with the Displayed Image

A combination of incorrect on-screen display (OSD) adjustments can cause problems with the displayed image. In this circumstance, a good first step toward a solution is to select the Auto Setup icon in your OSD to automatically set the adjustments to their optimum settings for your particular computer. This sets up your monitor with standard video timings and provides a good starting place for fine-tuning adjustments.

### Image does not fill the screen.

The current video mode has a resolution less than the monitor's pixel format. For example, the video mode is 640 X 480, and the monitor's pixel format is 800 X 600. Select the **Auto Setup** selection in the OSD.

### Image extends beyond the screen.

- 1 Select the **Auto Setup** selection in the OSD. Follow the steps below to fine tune these settings.
- 2 To fine tune the horizontal and/or vertical position for the current video mode, use the **Horizontal Position** and/or **Vertical Position** selection to center the image on the screen.
- 3 To fine tune the horizontal size for the current video mode, use the **Clocks Adjust** selection to fit the image completely on the screen.

**Characters shimmer or appear fuzzy.**

- 1 Select the **Auto Setup** selection in the OSD. Follow the steps below to fine tune these settings.
- 2 To fine tune the clock phase for the current video mode, use the **Phase Adjust** selection to sharpen the image.
- 3 To fine tune the horizontal size for the current video mode, use the **Clocks Adjust** selection to fit the image completely on the screen.

**Important** This problem may occur if the horizontal size is adjusted by as little as one pixel too few or too many, so try to make as precise an adjustment as possible.

- 4 The current vertical refresh rate may not be optimal. If your computer's video card and driver supports it, change the vertical refresh rate until you find one that looks best with the monitor. This configuration is set within the **Control Panel → Display Settings** dialog.

**When video mode is changed, the screen image shifts left or right.**

The image's horizontal position has not been optimized for the new video mode. First select the **Auto Setup** selection, then use the **Horizontal Position** selection to fine tune centering the image horizontally on the screen.

**When video mode is changed, the screen image shifts up or down.**

The image's vertical position has not been optimized for the new video mode. First select the **Auto Setup** selection, then use the **Vertical Position** selection to center the image vertically on the screen.

**Vertical bands appear in the image.**

- 1 Select the **Auto Setup** selection in the OSD. Follow the steps below to fine tune these settings.
- 2 To fine tune the clock phase for the current video mode, use the **Phase Adjust** selection to sharpen the image.
- 3 To fine tune the horizontal size, use the **Clocks Adjust** selection to fit the image completely on the screen.

**Important** This problem may occur if the horizontal size is adjusted by as little as one pixel too few or too many, so try to make the adjustment as precise as possible.

- 4 The current vertical refresh rate may not be optimal. If your video card and driver supports it, change the vertical refresh rate until you find one that looks best with the monitor. This configuration is set within the **Control Panel → Display Settings** dialog.

**Image appears faded or "washed out."**

The image's contrast is set too high. First select the **Auto Setup** selection, then use the **Contrast** selection to lower the contrast setting.

# Monitor Specifications



This appendix outlines important specifications for the monitor. It is a good idea to familiarize yourself with these specifications before operating the monitor.

## Physical Specifications

---

The monitor's physical specifications are listed in the table below.

**Table A-1: Physical Specifications**

Category	Specifications
Dimensions (H x W x D)	<ul style="list-style-type: none"><li>15" Monitor (with stainless steel bezel) — 13.3" x 16.8" x 3.1" (338mm x 427mm x 77.9mm)</li><li>15" Monitor (with standard bezel) — 13.3" x 16.8" x 3.5" (338mm x 427mm x 89.6mm)</li><li>17" Monitor (with standard bezel) - 15.7" x 18" x 3.2" (399mm x 457mm x 80.5mm)</li></ul>
I/O Ports	<ul style="list-style-type: none"><li>Video Input — Analog RGB through a standard 15-pin DSUB connector</li><li>Touchscreen output — Serial RS232 (DCE) through a standard 9-pin DSUB connector</li></ul>
Weight	<ul style="list-style-type: none"><li>15" Monitor (with stainless steel bezel) - 14.4 lbs. (6.5Kg)</li><li>15" Monitor (with standard bezel) - 11.2 lbs. (5.1Kg)</li><li>17" Monitor (with standard bezel) - 17.9 lbs. (8.1Kg)</li></ul>
Touchscreen	<ul style="list-style-type: none"><li>Analog Resistive</li></ul>

## Display Specifications

---

Display specifications for the monitor are shown in the table below.

**Table A-2: Display Specifications**

Category	Specifications
<b>15" Monitor</b>	
Color depth	Up to 16 million colors
Brightness	260 NITS
Bulb Life	50,000 hours
Resolution	XGA 1024 X 768

**Table A-2: Display Specifications**

Category	Specifications
<b>17" Monitor</b>	
Color depth	Up to 16 million colors
Brightness	250 nits
Backlight lifetime	50,000 hours
Pixel format	SXGA 1280 X 1024

## Environmental Specifications

---

The monitor conforms to the environmental specifications listed in the table below.

**Table A-3: Environmental Specifications**

Category	Specifications
Operating temperature	32° to 122°F (0° to 50°C) ambient (air temperature outside of backshell)
Storage temperature	-13° to 185°F (-25° to 85°C)
Relative humidity	95% @ Ta < or = 104°F (40°C) non-condensing
Shock rating	<ul style="list-style-type: none"> <li>• Operating — 10g 11ms pulse</li> <li>• Non-operating — 30g 11ms pulse</li> </ul>
Operating vibration	10–500 Hz 1 grms
Faceplate Design	Tested for UL Type 4/4X environment  <b>Warning:</b> The monitor is rated NEMA 4 only if it is installed in a NEMA 4 rated enclosure.



**Caution:** Remember that the temperature within a protective enclosure is generally higher than the external temperature. Thus, if the monitor is operating inside an enclosure at temperature levels above its rated ambient temperature, you must cool the enclosure.

Limit the monitor's exposure to adverse conditions, such as dust, oil, moisture, and corrosive vapors in order to minimize maintenance and repair costs.

## Electrical Specifications

---

The monitor's electrical specifications are shown in the table below.

**Table A-4: Electrical Specifications**

Category	Specifications
Input voltage	24 VDC @ 2A max
Power requirements	48 Watts maximum
Fuse rating	4A (very fast-acting type)



The monitor's power supply automatically detects the input voltage level and adjusts accordingly. However, always use reliable sources of power and isolate all communication cables from AC power lines to enhance noise immunity.

**Important** If possible, position the monitor away from machinery that produces intense electrical noise (arc welders, etc.). Otherwise, isolate the input power to the monitor from the equipment generating electrical noise.

## Testing Specifications

---

The monitor conforms to the emission standards for electronic equipment EN61000-6-2 (2001) and EN55011 (A2:2002), shown below.

**Table A-5: European Community Immunity and Emission Standards**

Test	Specification
ESD immunity	EN61000-4-2
RF immunity	EN61000-4-3
Electrical fast transient/burst	EN61000-4-4
Surge immunity	EN61000-4-5
RF common mode immunity	EN61000-4-6
Power frequency magnetic field immunity	EN61000-4-8
Voltage dip and interrupt immunity	EN61000-4-11
Conducted & radiated emissions	EN55011

**Table A-6: Mechanical Testing Specifications**

Test	Specification
Surge withstanding capacitance	EN61000-4-5
Operating vibration	0.5 grms/MIL-STD-810F 514.3
Mechanical shock	IEC-68-2-27/MIL-STD-810F 514.3
Non-operational vibration	1.0 grms/MIL-STD-810F 514.3

## Faceplate Chemical Resistance

---

The monitor's screen can resist the chemicals listed below, with no visible effect.

**Table A-7: Faceplate Chemical Resistance Specifications**

Screen Chemical Resistance		
Properties	HA210	Test Methods
cosmetics	OK	naked eye
total thickness (gauge)	710	micrometer
pencil hardness	3H	JIS 5400
adhesion	100/100	1mm - 100 grid cross hatch/snap tape test
steel wool	pass	rub
VLT(%)	92.2	BYK Gardner Hazegard Plus
haze	8.63	BYK Gardner Hazegard Plus
clarity	76.5	BYK Gardner Hazegard Plus
gloss	108	BYK Gardner Hazegard Plus
L*	94.9	Hunterlab colorimeter
a*	-0.12	Hunterlab colorimeter
b*	1.10	Hunterlab colorimeter
chemical resistance in Acetic Acid	pass	ambient temp/24 hours
chemical resistance in 5% NaOH	pass	ambient temp/24 hours
chemical resistance in 35% HCl	pass	ambient temp/3 hours
solvent resistance to Benzene	pass	ambient temp/0.5 hours
solvent resistance to Toluene	pass	ambient temp/24 hours
solvent resistance to Ethanol	pass	ambient temp/24 hours
solvent resistance to Acetone	pass	ambient temp/24 hours
solvent resistance to Ethyl Acetate	pass	ambient temp/24 hours

All monitor surfaces exposed outside of an enclosure are resistive to the following chemicals:

- Commercial glass cleaners
- Ammonia (10% dilute solution)
- Motor oil
- Hydraulic fluid
- Diesel fuel
- Gasoline (leaded and unleaded)
- Silicone-based lubricant
- Alcohol (ethyl, methyl)
- Automatic transmission fluid



**Caution:** Sustained exposure to brake fluid or Gunk<sup>®</sup> brand degreaser can cause damage to monitor materials.

## Touchscreen Cable Diagram

The diagram below shows the connections between the monitor and a host computer.

**Figure A-1: Touchscreen Cable Diagram**

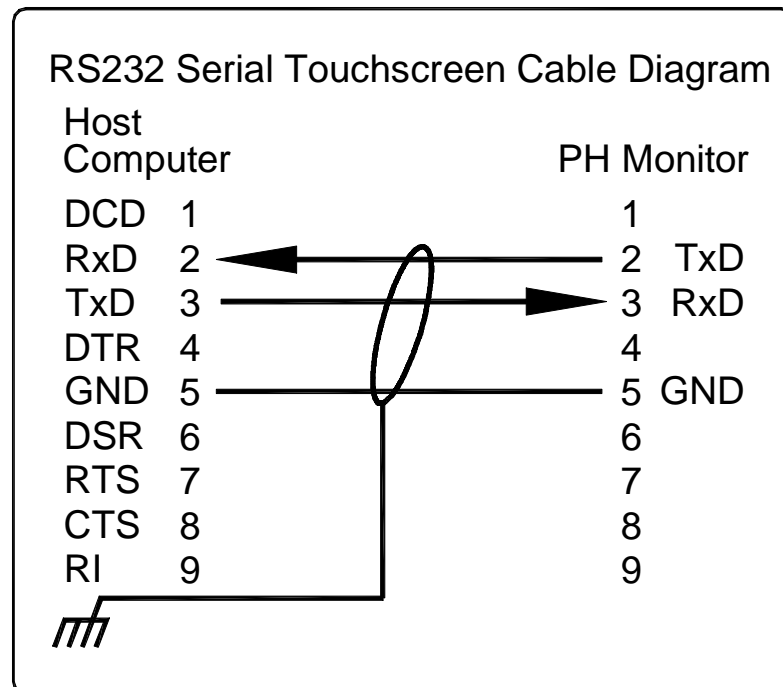

## Video Input Signals

---

The table below shows the video inputs from a host computer to the monitor.

**Table A-8: Video Cable Specifications**

Video Cable Signals		
1 Red	6 Green Shield	11 N/C
2 Green	7 Blue Shield	12 DDC DATA
3 Blue	8 GND	13 HSYNC
4 N/C	9 5 V IN	14 VSYNC
5 Red Shield	10 CABLE DETECT	15 DDC CLOCK



# PM1 Monitor Installation

# B

This appendix is for use with the PM1 monitor only. It lists the basic steps needed to install and setup the monitor, as well as details the procedures that are different than installing the PHM monitor. If you have a PHM monitor, refer to *Chapter 2: Installing the Monitor* for installation procedures.

To install the PM1 monitor, follow the steps below:

- 1 Select a location for the monitor. See *Selecting a Location* on page 2-1, for details.
- 2 Mount the monitor. See *Mounting the Monitor in an Enclosure* on page 2-6, for more information.
- 3 Connect the monitor to a computer. See *Connecting to a Non-display Computer* on page B-2, or *Connecting to Other Computers* on page 3-2, for details.
- 4 Start up the monitor. Refer to *Setting Up the Monitor* on page 3-4 for more information.
- 5 Install the touchscreen driver. See *Installing the Touchscreen Driver* on page B-2, for details on installing the UPDD driver.
- 6 Calibrate the touchscreen. Refer to *Calibrating the Touchscreen Driver* on page B-3, for more information.
- 7 Adjust the video image. See *Step 3: Adjusting the Video Image* on page 3-5, for details.

## Connecting to a Non-display Computer

---

To connect your monitor to one of the non-display PowerStations, complete the following steps:

- 1 Connect the 15-pin video cable to the Analog Video Input port on both the monitor and the non-display PowerStation, see Figure B-1:.
- 2 Connect the 9-pin touchscreen cable to the Touchscreen port on the monitor and to the COM3(C) communication port.

**Figure B-1: Communication Ports on the Monitor**

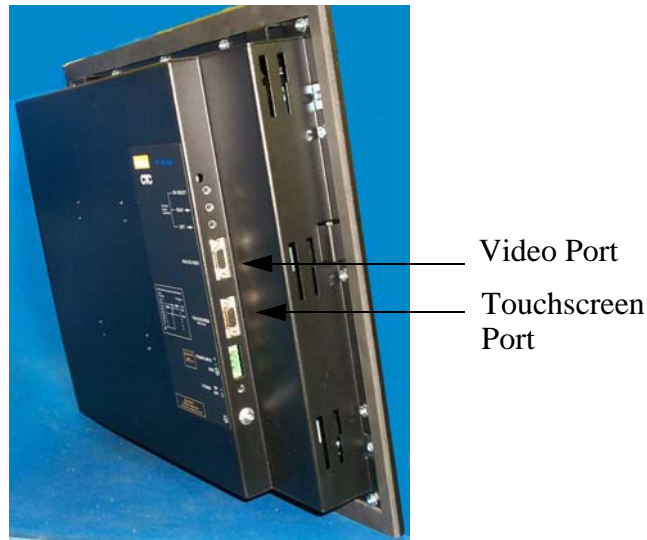

## Installing the Touchscreen Driver

---

If you purchased a CTC non-display PowerStation with your monitor, a touchscreen driver was installed in your PowerStation before it shipped.

If you are using your monitor with another computer, or if your system becomes damaged, you need to install (or reinstall) the touchscreen driver.

To install the 3M/Dynapro touchscreen driver, use the product CD that came with the monitor.

- 3 Load the CD. The PowerStation Utility CD menu is displayed.
- 4 Click on **Drivers** from the menu on the left-hand side of the screen. The Drivers menu is displayed.
- 5 Click on **PM1 Monitor**. The PM1 Monitor Driver menu is displayed.
- 6 Select either the **Parker-CTC PowerStation** or the **Generic Computer** button depending on the type of computer you are using. The UPDD driver installation is launched.
- 7 Follow the online instructions to install the touchscreen driver.

The touchscreen driver used with the PM1 monitor is the 3M/Dynapro UPDD driver. This driver is located on the CD that shipped with your monitor in the following folder:

*Drivers → Touch → PM1*

This driver is also located on the OS image in the following directory:

C:\UPDD

Review the *Install Readme.txt* file associated with the touchscreen driver for more information on installing it, if necessary.

## Calibrating the Touchscreen Driver

---

Calibrating the touchscreen ensures that it is aligned with your display. The monitor's touchscreen is calibrated before leaving Parker-CTC. However, you may need to recalibrate the touchscreen when you begin using the monitor for the first time or whenever the cursor location and the location on the screen where the user touches do not match.

This section explains how to calibrate the 3M/Dynapro touchscreen driver under Windows 2000 and XP Professional.

To calibrate the touchscreen driver, complete the following steps:

- 1 Select **Start → Programs → UPDD → Calibrate**.
- 2 Touch the center of each "+" sign as they appear on the screen. A total of five "+" signs are displayed.
- 3 Move your finger across the monitor. The target should move with your finger, indicating that the calibration was successful.

# INDEX

## A

- AC power supply
  - Guidelines 2-6
- adapter
  - AC 2-6
  - mounting 2-7
- adjust
  - image 3-7
- amps A-3
- Analog Video Input port 3-1, B-2
- auto setup menu 3-6

## B

- backshell
  - closing 4-4
  - opening 4-3
- brightness 3-6, A-1
- bulb A-1
- burst A-3

## C

- calibration
  - PHM monitors 3-5
  - PM1 monitors B-3
- chemical resistance A-4
- clamp assembly 2-9
- Class I, Division 2 guidelines 2-1
- clock 3-7
- color 3-7
  - depth A-1
- com port
  - PHM monitor 3-2
  - PM1 monitor B-2
- contrast 3-6
- controls
  - display 2-5
- cover
  - closing 4-4
  - opening 4-3
- cutout
  - creating 2-6
  - dimensions 2-6

## D

- dimensions A-1
- display
  - controls 2-5
- documentation
  - library 1-1
  - standards 1-2

## drivers

- CD directory B-3
- installing
  - PHM driver 3-4
  - PM1 driver B-2

## E

- electrical guidelines 2-3
- electrostatic discharge 4-2
- emissions 2-5, A-3
- enclosure
  - guidelines 2-4
- environmental guidelines 2-2
- equipment
  - permanent connection 3-2
  - pluggable 3-2
- ESD 4-2
  - immunity A-3
- exit 3-7

## F

- faceplate
  - design 2-4
- factory recall 3-7
- fuse
  - maintenance 4-2
  - part number 4-5
  - rating 2-3, A-3
  - replacing 4-5

## G

- generic computer
  - connecting to 3-2
- getting started 1-4

## H

- horizontal position 3-6
- humidity
  - guidelines 2-4
  - relative 2-4, A-2

## I

- I/O ports A-1
- image
  - adjusting 3-5, 3-7
  - beyond screen 4-7
  - blank 4-6
  - doesn't fill screen 4-7
  - washed out 4-8
- immunity standards A-3
- input voltage 2-3, A-3

## installing

- location 2-1
- mounting the monitor 2-8
- TSHARC driver 3-4
- UPDD driver B-2

interrupt immunity A-3

## L

- language 3-7
- location 2-1

## M

- magnetic field immunity A-3
- maintenance 4-1 to 4-4
- management menu 3-6
- monitor
  - adjusting image 3-5
  - bulb life A-1
  - calibrating 3-5
  - color depth A-1
  - controls 3-6
  - dimensions A-1
  - I/O ports A-1
  - mounting 2-8
  - mounting diagram 2-9
  - on-screen display 3-5
  - OS compatibility 3-1
  - resolution A-1
  - setup 3-4
  - weight A-1
- mounting diagram 2-9

## O

- on-screen display
  - controls 3-6
  - menu 3-6
- operating temperature 2-4, A-2
- operating vibration 2-4
- OSD 3-5
  - auto setup 3-6
  - controls 3-6
  - display 3-7

## P

- permanently connected 3-2
- phase 3-7
- PHM monitors
  - calibrating 3-5
  - drivers
    - installing 3-4
- pluggable 3-2

- PM1 monitors
  - com port B-2
  - installing B-1
  - touchscreen driver B-2
- ports
  - accessing 2-5
  - connecting to 3-1
- power requirements 2-3, A-3
- PowerStations
  - connecting to 3-1
- problems 4-6 to 4-8
  - image 4-7

**R**

- relative humidity 2-4, A-2
- resolution A-1
- RF immunity A-3
- RS232 serial diagram A-5

**S**

- screen
  - blank 4-6
  - cleaning 4-1
  - shifts 4-8
- screw assembly 2-9
- shock
  - mechanical A-4
  - rating 2-4, A-2

- specifications A-1 to A-5
  - chemical resistance A-4
  - display A-1
  - electrical 2-3, A-3
  - faceplate 2-2
  - physical A-1
  - testing A-3
- starting your system 3-2
- storage temperature 2-4, A-2
- support
  - contacting 1-4
  - services 1-3
- surge immunity A-3
- symbols
  - caution 1-2
  - warning 1-2

**T**

- temperature
  - guidelines 2-4
  - operating 2-4, A-2
  - storage 2-4, A-2
- torque 2-9
  - wiring 2-3
- touchscreen A-1
  - cable diagram A-5
  - com port
    - PHM monitors 3-1
    - PM1 monitors B-2
  - drivers 3-4, B-2
  - not calibrated 4-7
  - not working 4-7
  - recalibrating 4-1
- training 1-4
- TSHARC driver 3-4

**U**

- UL 2-1, 2-3
- Underwriters Laboratories 2-1, 2-3
- UPDD driver
  - installing B-2

**V**

- vertical bands 4-8
- vertical position 3-6
- vibration 2-4, A-2, A-4
- video image
  - adjusting 3-5
- video input signals A-6
- voltage dip A-3

**W**

- weight A-1
- wiring requirements 2-3