

General Description

Series 2F1C 2-way flow control valves provide pressure and viscosity compensated flow from port A to port B. The counter direction is blocked (standard) or can be open via an integral reverse flow check valve (optional).

Operation

The compensator spool is located in front of the metering spool. The metering spool is closed in the neutral position to avoid undesired initial actuator motion. The oil flow to open the metering spool has to pass a needle valve (not shown in the sectional drawing). The needle valve can be adjusted from the front panel to set the response time of the 2F1C.

The metering spool is adjusted by the main control knob. The key lock has three positions:

- Lock: Adjustment is locked.
- Adjust: Full adjustment is permitted.
- Trim: Fine adjustment of $\pm 5\%$ is possible.

Features

- 2 way flow control valve.
- Subplate mounting according to ISO 6263.
- Excellent fine adjustment.
- Adjustable response time.
- Closed in neutral position.
- Optional reverse flow check valve.
- 2 sizes: NG10 (3/8"), NG16 (3/4").

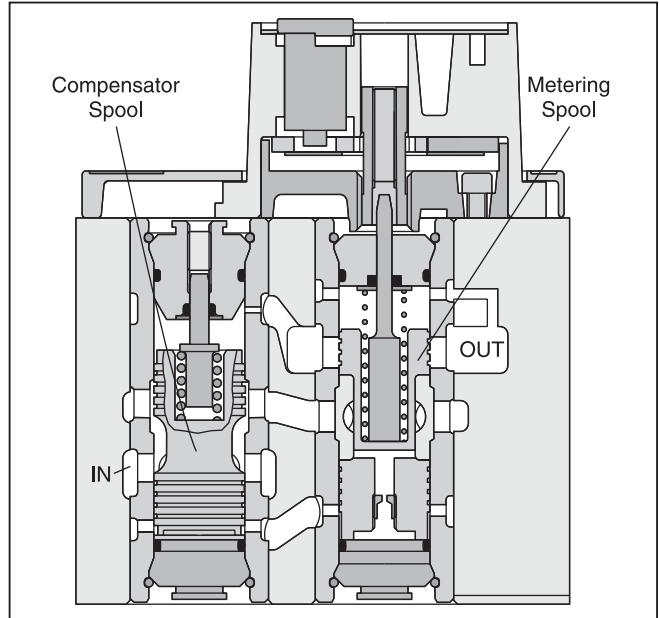
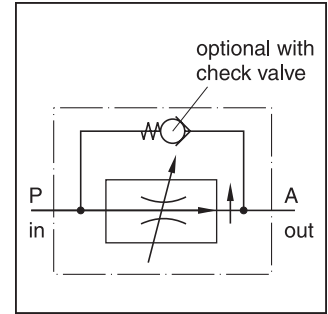

Ordering Information

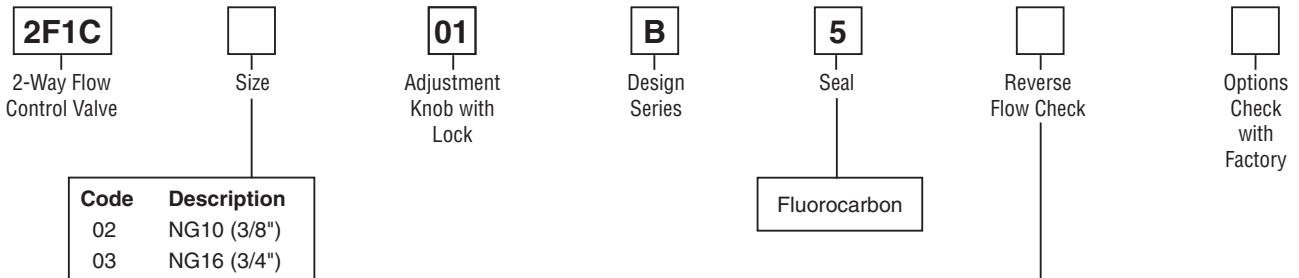

Weight:

- 2F1C02 6.0 kg (13.2 lbs.)
- 2F1C03 9.0 kg (19.8 lbs.)

Size		NG10	NG16
Actuator		Manual flow rate adjustment	
Mounting Type		ISO 6263	
Mounting Position		Unrestricted	
Fluid Temperature		+70°C (+158°F) Maximum	
Ambient Temperature		-25°C to +50°C (-13°F to +122°F)	
Viscosity Range		2.8 to 400 cSt / mm ² /s (13 to 1854 SSU)	
Filtration		ISO 4406 (1999); 18/16/13 (meet NAS 1638:7)	
Maximum Pressure Difference		See Diagram	
Maximum Operating Pressure	Port A	2F1C02 14 - 280 Bar (203 - 4060 PSI) 0 - 270 Bar (0 - 3915 PSI)	2F1C03 14 - 350 Bar (203 - 5075 PSI) 0 - 340 Bar (0 - 4930 PSI)
	Port B		
Flow Direction	A-B	Flow control function	
	B-A	Blocked or free flow through check valve	

E

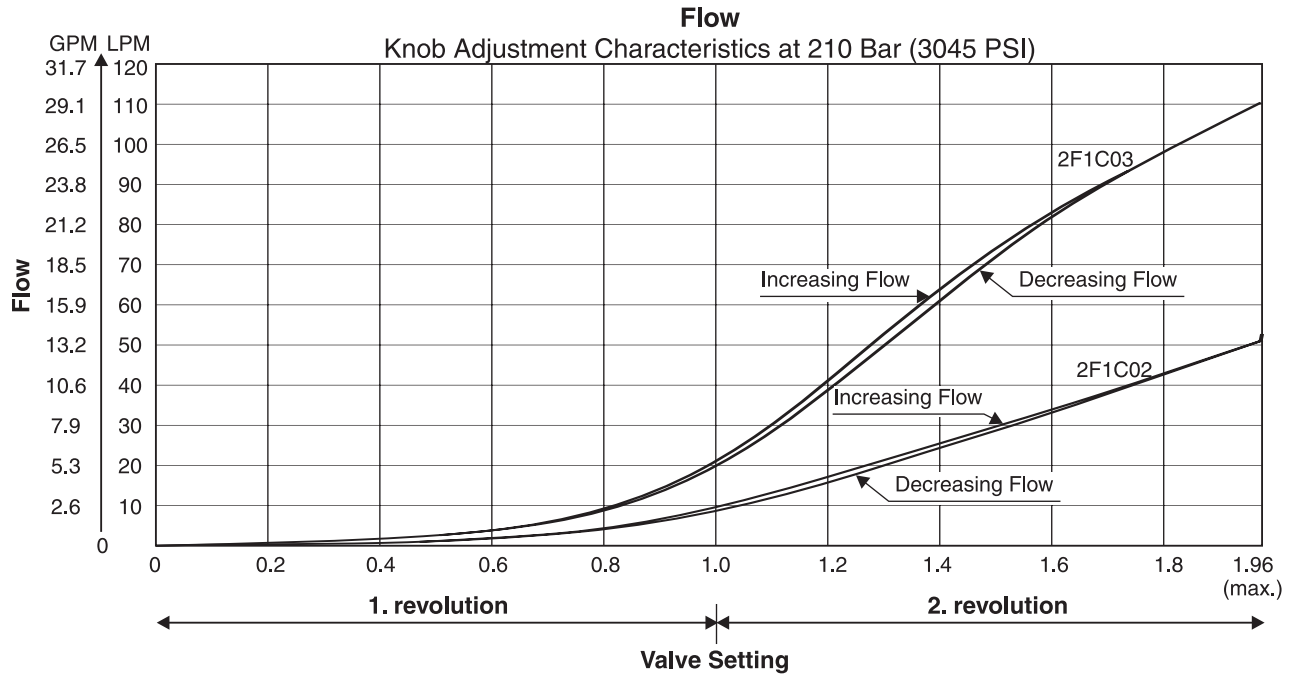

2F1C02

Flow / Pressure Drop
 Constant Inlet Pressure – Variable Outlet Pressure

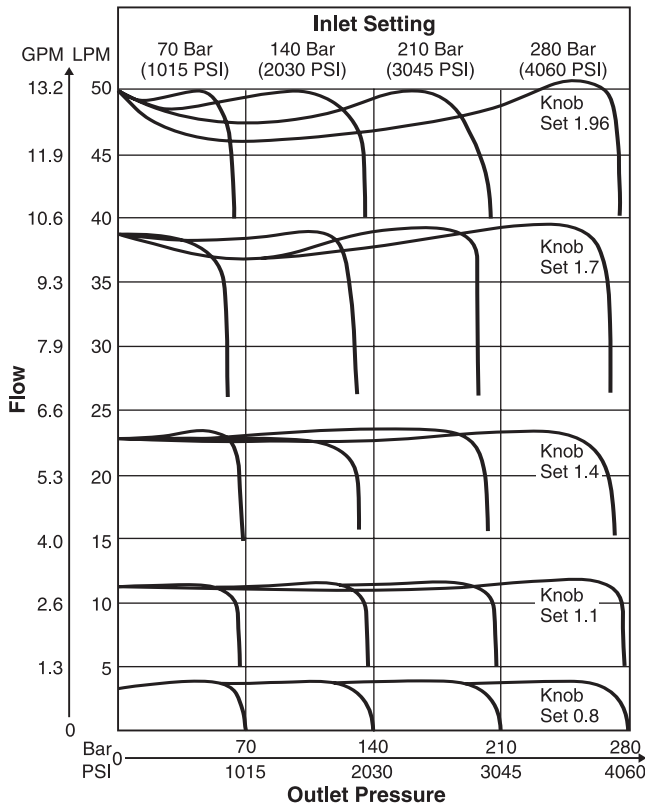

2F1C03

Flow / Pressure Drop
 Constant Inlet Pressure – Variable Outlet Pressure

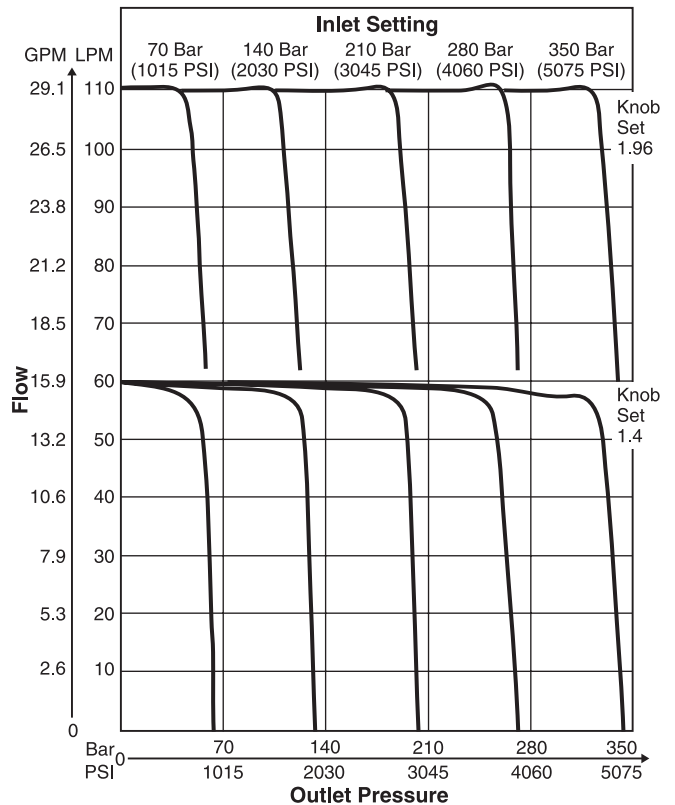

Fluid viscosity 40 cSt at 50°C (122°F)

2F1C.indd, dd



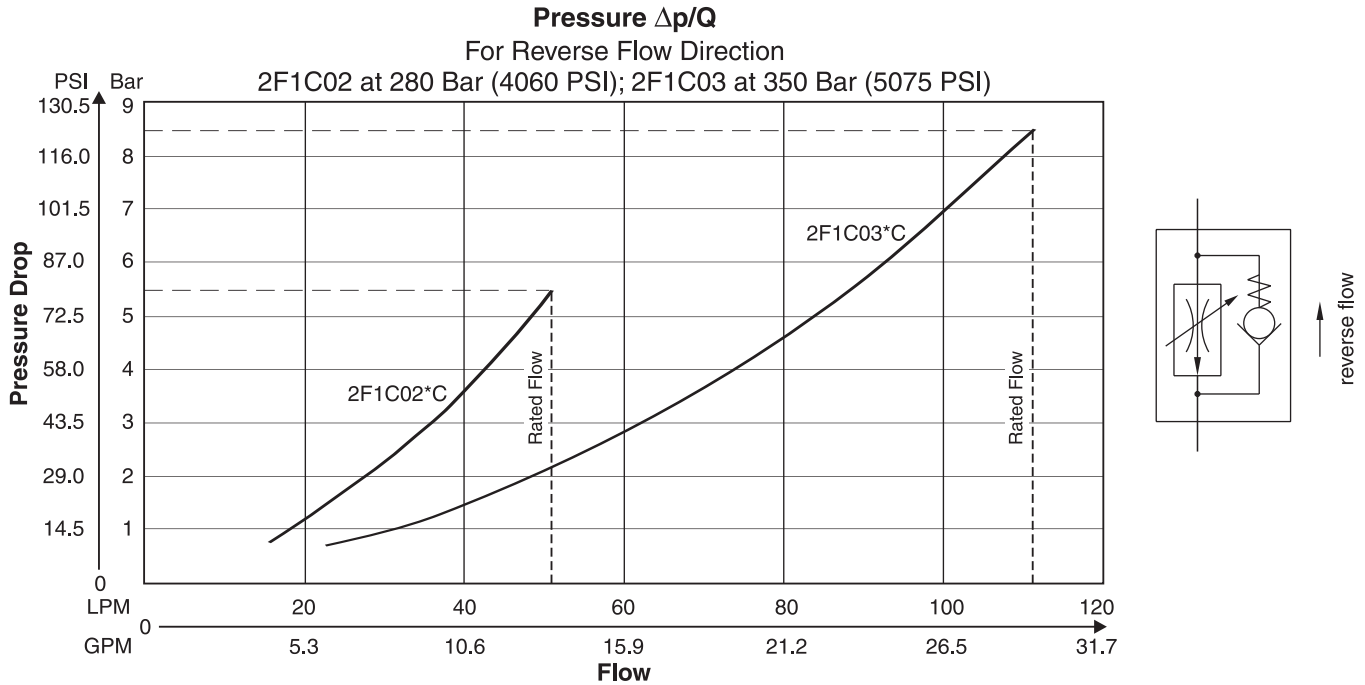

2F1C02

2F1C03

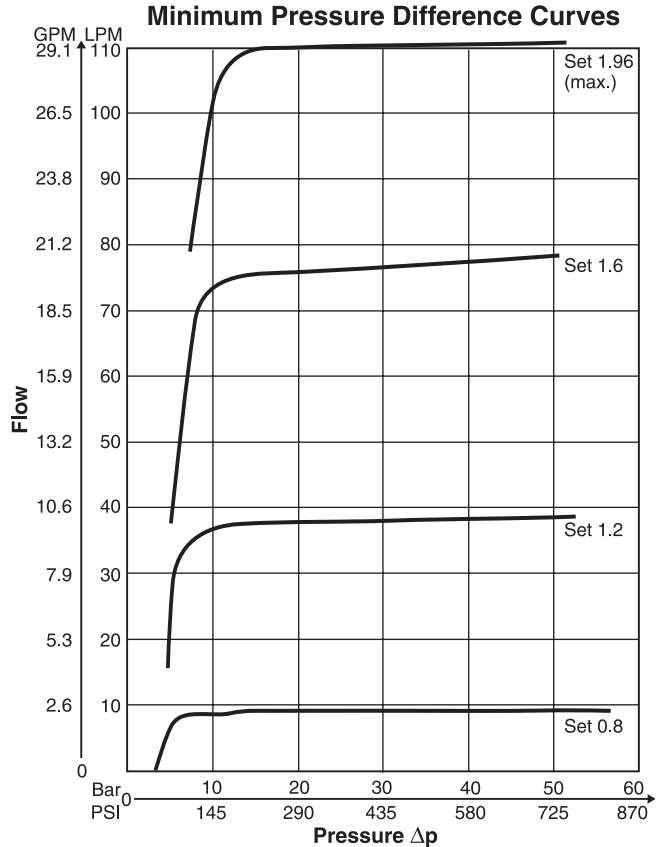
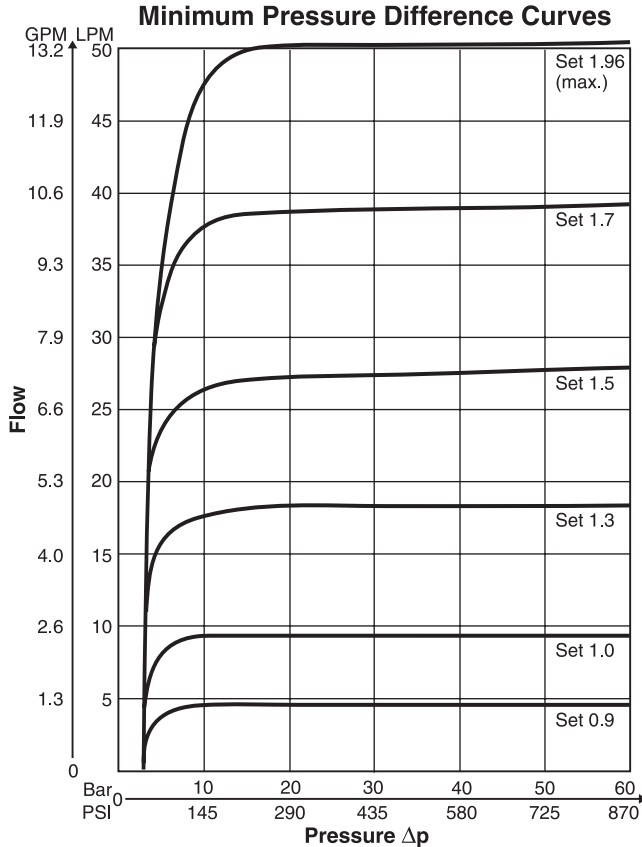

Fluid viscosity 40 cSt at 50°C (122°F)

2F1C.indd, dd



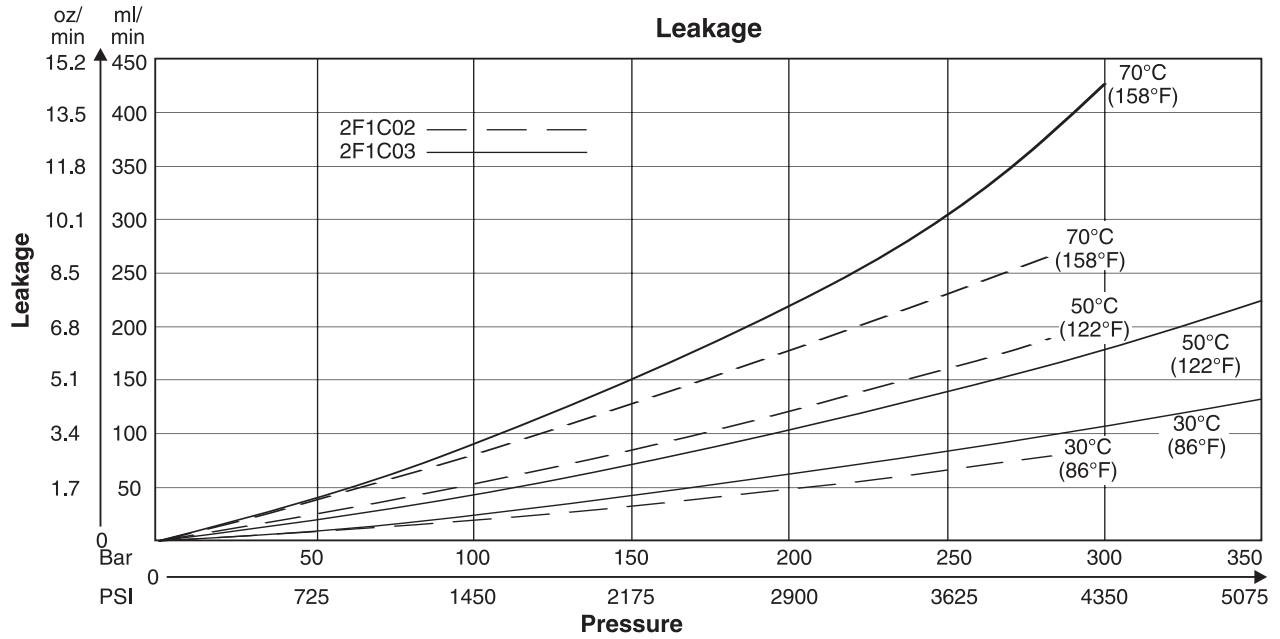

2F1C02

2F1C03

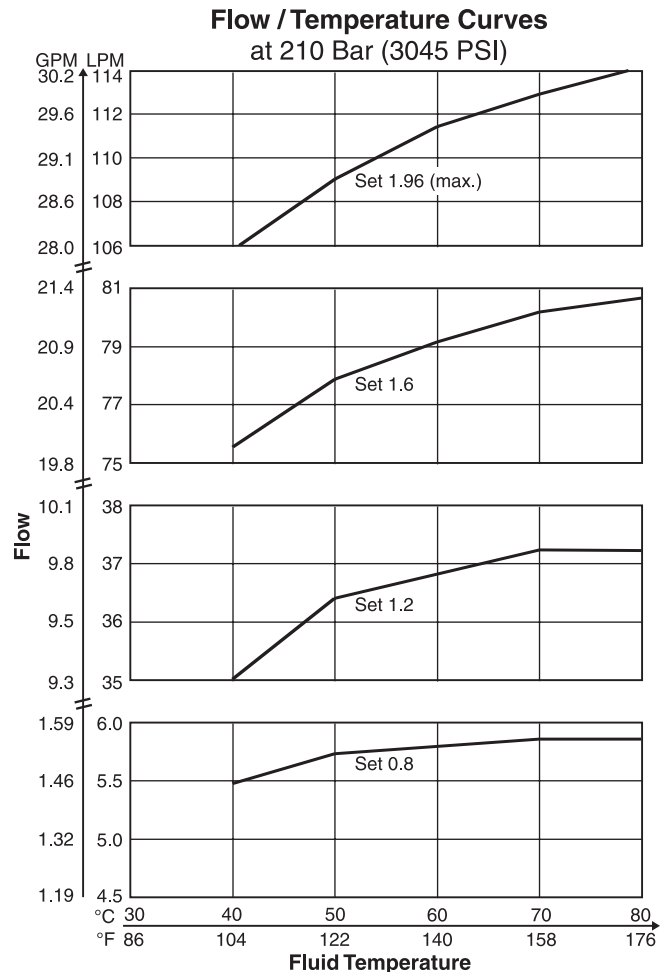
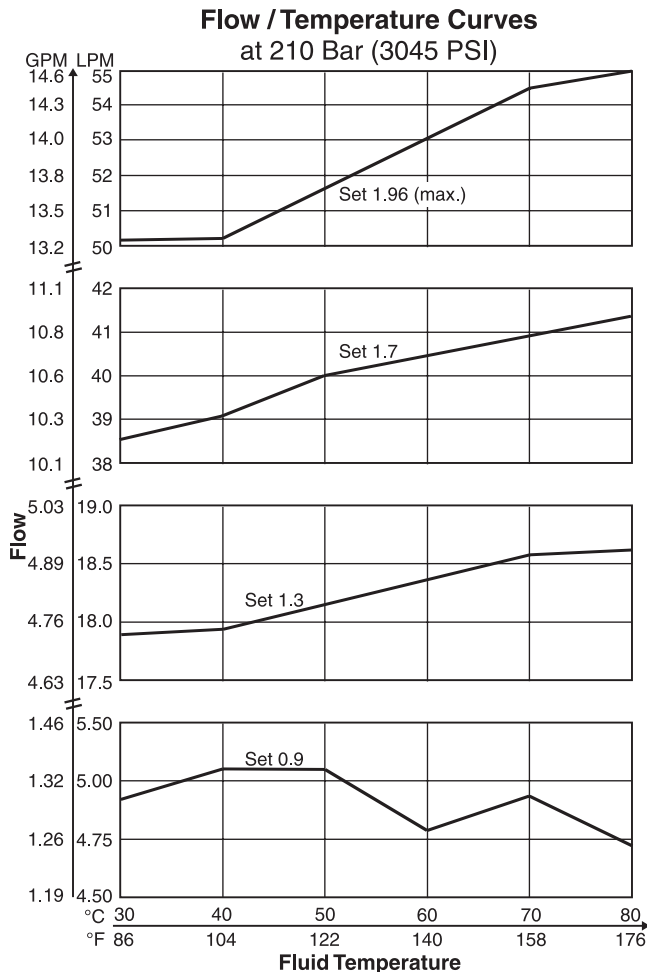

Fluid viscosity 40 cSt at 50°C (122°F)

2F1C.indd, dd

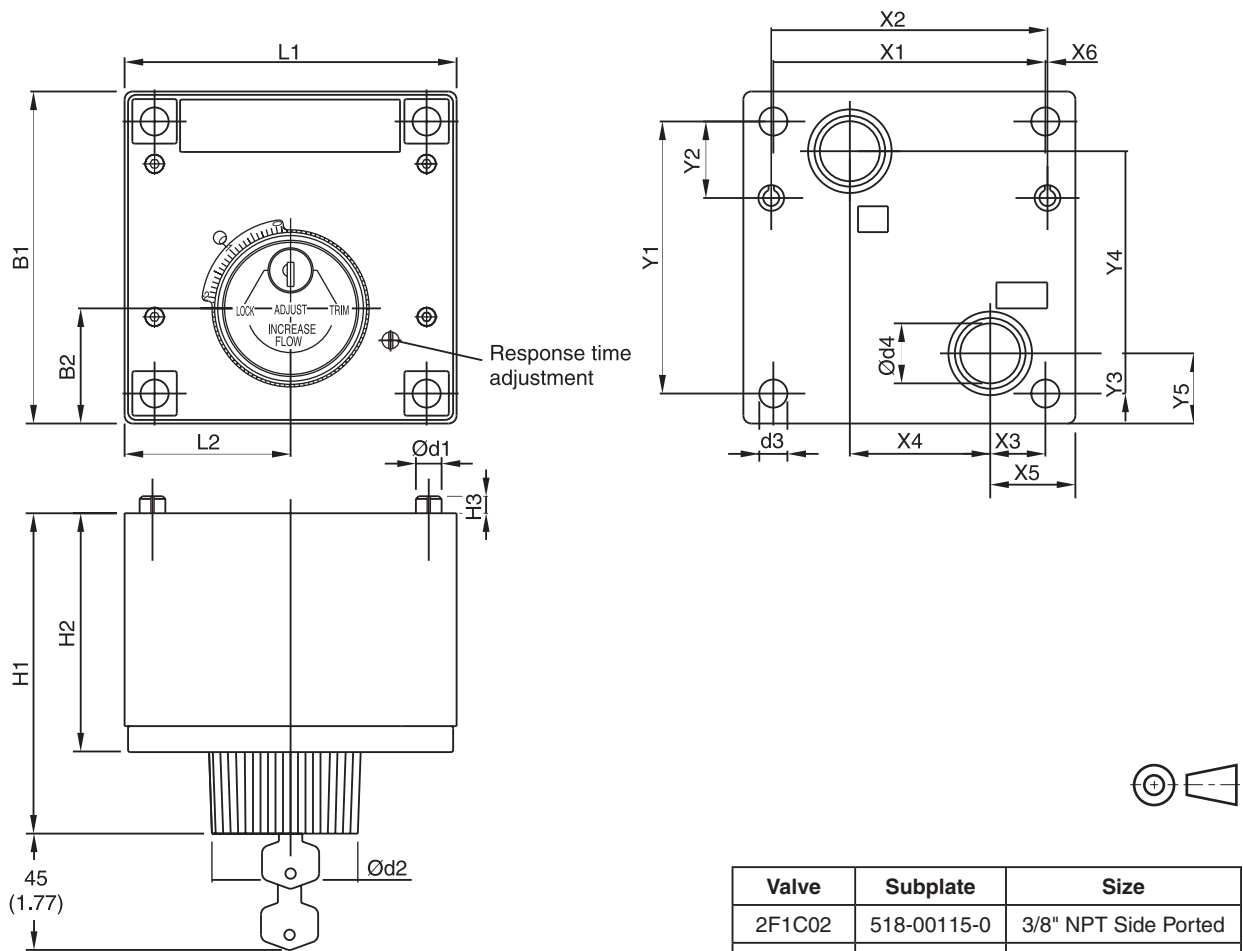

Inch equivalents for millimeter dimensions are shown in (**)



Valve	Subplate	Size
2F1C02	518-00115-0	3/8" NPT Side Ported
2F1C03	518-00118-0	1/2" NPT Side Ported

Size	ISO-code	x1	x2	x3	x4	x5	x6	y1	y2	y3	y4	y5
02	6263-AM-07-2-A	76.2 (3.00)	79.4 (3.13)	9.5 (0.37)	44.5 (1.75)	19.0 (0.75)	-	82.5 (3.25)	23.8 (0.94)	30.2 (1.19)	41.3 (1.63)	39.7 (1.56)
03	6263-AK-06-2-A	101.6 (4.00)	103.2 (4.06)	20.6 (0.81)	52.4 (2.06)	31.8 (1.25)	0.8 (0.03)	101.6 (4.00)	28.6 (1.13)	15.1 (0.59)	75.4 (2.97)	26.2 (1.03)

Size	ISO-code	B1	B2	H1	H2	H3	L1	L2	d1	d2	d3	d4
02	6263-AM-07-2-A	101.6 (4.00)	38.1 (1.50)	119.6 (4.71)	87.4 (3.44)	6.4 (0.25)	95.2 (3.75)	47.6 (1.87)	6.4 (0.25)	57.2 (2.25)	8.7 (0.34)	14.2 (0.56)
03	6263-AK-06-2-A	123.8 (4.87)	42.9 (1.69)	121.4 (4.78)	89.2 (3.51)	6.4 (0.25)	123.8 (4.87)	61.9 (2.44)	9.5 (0.37)	57.2 (2.25)	10.5 (0.41)	22.4 (0.88)

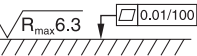
Size	ISO-Code	Bolt Kit  DIN912 12.9		Seal  Kit Fluorocarbon	Surface Finish 
02	6263-AM-07-2-A	BK-700-70842-8 4xM8x100	31.8 Nm (23.5 lb.-ft.) ±15%	S26-98617-5	$\sqrt{R_{max}6.3}$ $\square 0.01/100$
03	6263-AK-06-2-A	BK395 4xM10x100	63 Nm (46.5 lb.-ft.) ±15%		