



Bulletin HY11-5715-641/UK

Operation Manual Series DFplus Pilot Operated

Design > 10

Proportional Directional Control Valve



Parker Hannifin
Manufacturing Germany GmbH & Co. KG
Hydraulic Controls Division Europe
Gutenbergstr. 38
41564 Kaarst, Germany
Tel.: (+49) 181 99 44 43 0
E-mail: infohcd@parker.com
Copyright © 2011, Parker Hannifin Corp.

Note

This document and other information from Parker-Hannifin Corporation, its subsidiaries and authorized distributors provide product or system options for further investigation by users having technical expertise.

The user, through its own analysis and testing, is solely responsible for making the final selection of the system and components and assuring that all performance, endurance, maintenance, safety and warning requirements of the application are met. The user must analyze all aspects of the application, follow applicable industry standards, and follow the information concerning the product in the current product catalog and in any other materials provided from Parker or its subsidiaries or authorized distributors.

To the extent that Parker or its subsidiaries or authorized distributors provide component or system options based upon data or specifications provided by the user, the user is responsible for determining that such data and specifications are suitable and sufficient for all applications and reasonably foreseeable uses of the components or systems.

Chapter	Page
1. Introduction	4
Order Code	4
Name Plate	5
Block Diagram of Integral Electronics	5
Characteristics of Valve Driver	5
Specifications	6
2. Safety Instructions	7
Symbols	7
Marking, Name Plates	7
Work at the Valve	7
3. Important Details	7
Intended Usage	7
Common Instructions	7
Liability	7
Storage	7
4. Mounting / Installation	8
Scope of Supply	8
Mounting	8
Operation Limits	8
Pressure Fluids	8
Electrical Connection	9
Electrical Interfacing	10
5. Operation Instructions	16
Preferred Hydraulic Initial State	16
Solenoid Current Monitoring	16
Zero Position Adjustment	16
Air Bleeding of Hydraulic System	16
Filter	16
Flushing	16
6. Maintenance	17
7. Trouble Shooting	17
8. Accessories / Spare Parts	18
Accessories	18
Spare Parts	18

1. Introduction

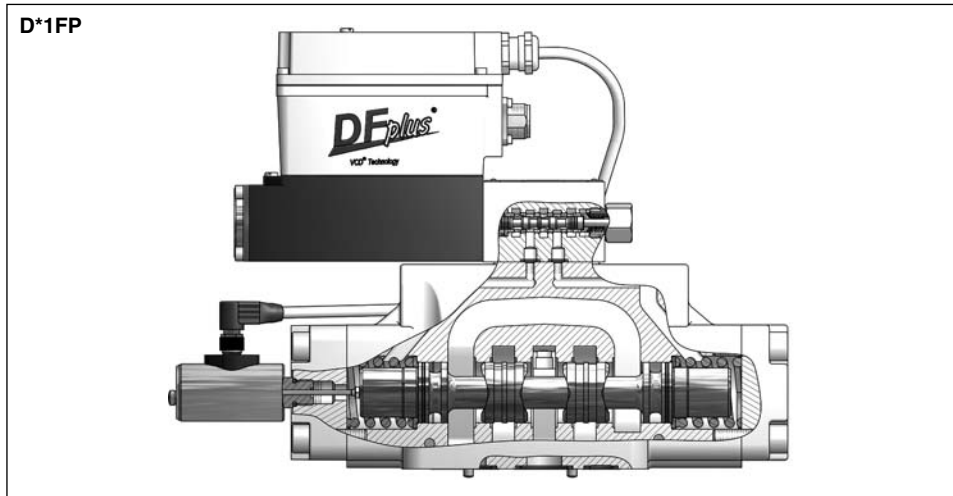

Ordering Code

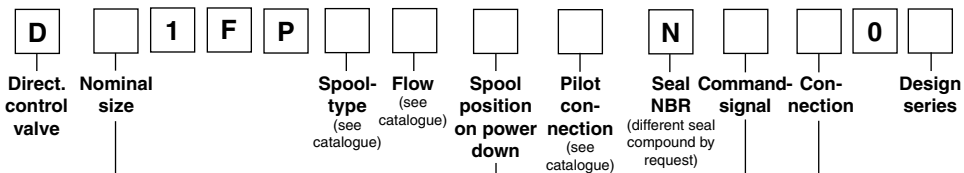

Code	Nominal size
3	NG10 / CETOP 5
4	NG16 / CETOP 7
8	NG25 / CETOP 8
9	NG25 / CETOP 8
11	NG32 / CETOP 10

Code	Connection
0	6 + PE
5	11 + PE
7	6 + PE w. Enable

Code	Spool pos. on power down
A	
B	
C	

Code	Signal	Flow direction
K	+/- 10V	0...+10V -> P-A
S	4...20mA	12...20mA -> P-A

D_FP 5715-641 UK.INDD RH 05.06.2012

Name Plate

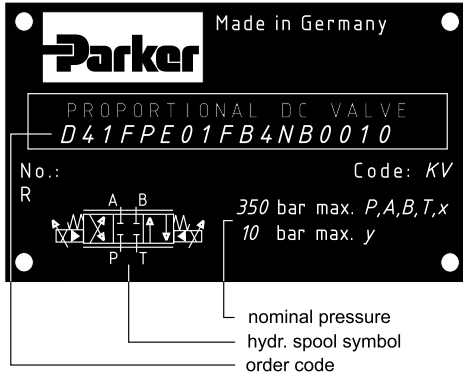

Parker D*1FP proportional directional control valves have an integral electronic and requires only one sole electrical common for the control system. Different flow sizes, fail-safe-functions as well as command signal options are available to achieve an optimal adaption for different applications.

Characteristics of Valve Driver

The described integral electronic driver combines all necessary functions for the optimal operation of the valve. Thanks to its excellent dynamic the valve is usable within closed loop control applications. The most important features are:

- high dynamic actuator principle with special designed electronic driver
- closed loop controlled pilot valve and main spool
- constant current actuator control with overcurrent shutoff
- excellent properties for response sensitivity and temperature drift
- differential input stage with various command signal options
- diagnostic output for spool stroke / overcurrent state
- standard central connection
- compatible to the relevant European EMC-standards



D_FP 5715-641 UK.INDD RH 05.06.2012

Block Diagram of Integral Electronics

Code 0 (6+PE)

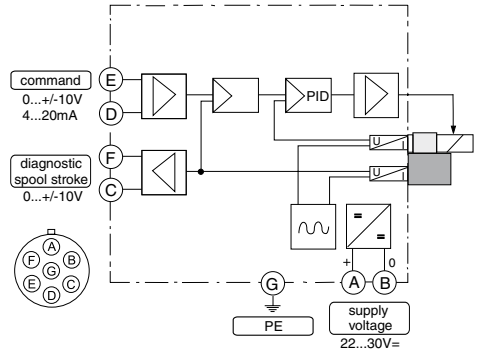

Code 5 (11+PE)

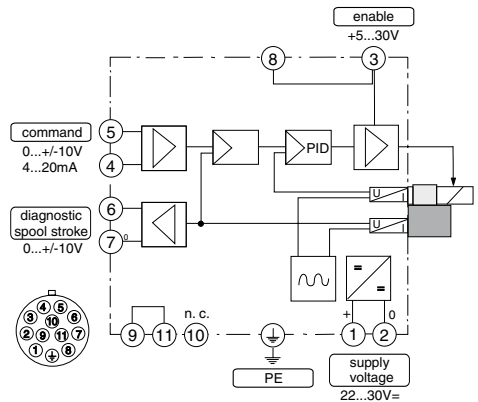

Code 7 (6+PE with enable)

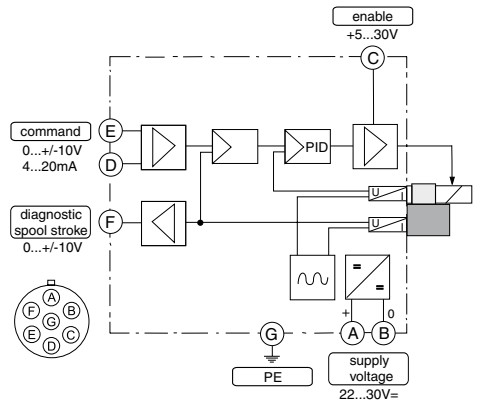

Technical Data

General	
Model	Proportional directional control valve, pilot operated
Drive	VCD®-actuator
Mounting Pattern	NG10 (CETOP 5) / NG16 (CETOP 7) / NG25 (CETOP 8) / NG32 (CETOP 10)
Installation Position	Any
Sensitivity [%]	< 0.05
Hysteresis [%]	< 0.1
Temp. Drift of Center Position [%/K]	< 0.025
Ambient Temperature Range [°C]	-20...+50
Protection Class	NEMA 4 (IP 65) acc. EN 60529
Vibration Strength [G]	25 acc. EN 60068, part 2-6
Weight [kg]	NG10 = 11.3 / NG16 = 14.2 / NG25 = 23.5 / NG32 = 64.5
Hydraulic	
Fluid Rate	Hydraulic oil acc. DIN 51524...535, other on request
Viscosity [SSU]	140...370
Fluid Temperature [°C]	-20...+50
Cleanliness	Purity level class acc. NAS 1638: class 7
Operating Pressure max. [bar]	350 for ports P, A, B, x / 35 for ports T, y at internal pilot oil 350 for port T at external pilot oil
Pilot Pressure Range [bar]	20...350 (optimum dynamic at 50)
Electrical	
Duty Ratio [%]	100
Supply Voltage [VDC]	22...30, ripple < 5% eff., surge free
Switch-On Current typ. [A]	22 for 0.2 ms
Current Consumption max. [A]	3.5
Pre-Fusing [A]	4.0 A medium lag
Command Signal Options [V] [mA]	+10...0...-10, ripple < 0.01 % eff., surge free, Ri = 100 kOhm 4...12...20, ripple < 0.01 % eff., surge free, Ri = 250 Ohm < 3.6 mA = enable off, > 3.8 mA = enable on acc. NAMUR NE43
Input Capacitance typ. [nF]	1
Differential Input Voltage max. [V]	Code 0: 30 for terminal D and E against PE (terminal G) 11 for terminal D and E against 0V (terminal B) Code 5: 30 for terminal 4 and 5 against PE (terminal ↓) 11 for terminal 4 and 5 against 0V (terminal 2) Code 7: 30 for terminal D and E against PE (terminal G)
Enable Signal [V]	Code 5: 5...30, Ri = 9 kOhm Code 7: 5...30, Ri = 9 kOhm
Diagnostic Signal [V]	+10...0...-10 / +Ub, rated max. 5 mA
EMC	EN 61000-6-2, EN 61000-6-4
Central Connection	Code 0: 6 + PE acc. EN 175201-804 Code 5: 11 + PE acc. EN 175201-804 Code 7: 6 + PE acc. EN 175201-804
Cable Specification	Code 0: 7 x AWG16 overall braid shield Code 5: 8 x AWG16 overall braid shield Code 7: 7 x AWG16 overall braid shield
Cable Length max. [m]	50

2. Safety Instructions

Please read the operation manual before installation, startup, service, repair or stocking! Paying no attention may result in damaging the valve or incorporated system parts.

Symbols

This manual uses symbols which have to be followed accordingly:



Instructions with regard to the warranty



Instructions with regard to possible damaging of the valve or linked system components



Helpful additional instructions

Marking, Name Plates

Instructions applied on the valve, i.e. wiring diagrams and name plates, must be observed and maintained legibly.

Work at the Valve

Workings in the area of installation, commissioning, maintenance and repair of the valve may only be allowed by qualified personnel. This means persons which have, because of education, experience and instruction, sufficient knowledge on relevant directives and approved technical rules.

3. Important Details

Intended Usage

This operation manual is valid for proportional directional control valves DFplus pilot operated series. Any different or beyond it usage is deemed to be as not intended. The manufacturer is not liable for warranty claims resulting from this.

Common Instructions

We reserve the right for technical modifications of the described product. Illustrations and drawings within this manual are simplified representations. Due to further development, improvement and modification of the product the illustrations might not match precisely with the described valve. The technical specifications and dimensions are not binding. No claim may result out of it. Copyrights are reserved.

Liability

The manufacturer does not assume liability for damage due to the following failures:

- incorrect mounting / installation
- improper handling
- lack of maintenance
- operation outside the specifications



Do not disassemble the valve! In case of suspicion for a defect please return the valve to the factory.

Storage

In case of temporary storage the valve must be protected against contamination, atmospheric exposure and mechanical damages. Each valve has been factory tested with hydraulic oil, resulting in protection of the core parts against corrosion. Yet this protection is only ensured under the following conditions:

Storage period	Storage requirements
12 months	constant humidity < 60% as well as constant temperature < 25°C
6 months	varying humidity as well as varying temperature < 35°C



Outdoor storage or within sea and tropical climate will lead to corrosion and might disable the valve!

4. Mounting / Installation

Scope of Supply

Please check immediately after receiving the valve, if the content is matching with the specified scope of supply. The delivery includes:

- valve
- operation manual

The central connector assembly has to be ordered separately and is not included in the delivery.

 Please check the delivery immediately after receiving the shipment for apparent damages due to shipping. Report shipment losses at once to the carrier, the insurance company and the supplier!

Mounting

- Compare valve type (located on the name plate) with part list resp. circuit diagram.
- The valve may be mounted fix or movable in any direction.
- Verify the mounting surface for the valve. Unevenness of 0.01 mm/100 mm, surface finish of 6.3 µm are tolerable values.

 Keep clean valve mounting surface and work environment!

- Remove protection plate from the valve mounting surface
- Check the proper position of the valve ports and the O-rings.
- Mounting bolts:
D31FP: 4 pcs. M6x40
D41FP: 2 pcs. M6x55, 4 pcs. M10x60
D81/91FP: 6 pcs. M12x95
D111FP: 6 pcs. M20x90
use property class 12.9, DIN 912

 Parker offers bolt kits:
D31FP: BK385, D41FP: BK320, D81/91FP: BK360, D111FP: BK 386

- Tighten the bolts crisscross with the following torque values:
D31FP: 13.2 Nm, D41FP: 13.2/63 Nm,
D81/91FP: 108 Nm, D111FP: 517 Nm

 Insufficient condition of the valve mounting surface might create malfunction! Incorrect mounting resp. bolt torque may result in abrupt leakage of hydraulic fluid on the valve ports.

Operation Limits

The valve may be operated within the determined limits only. Please refer to the "technical data" section as well as to the "characteristic curves" in the catalog.

 Follow the environmental conditions! Unallowable temperatures, shock load, aggressive chemicals exposure, radiation exposure, illegal electromagnetic emissions may result in operating trouble and may lead to failure! Follow the operating limits listed in the "specifications" table!

Pressure Fluids

The following rules applies for the operation with various pressure fluids:

 The above information serves for orientation and does not substitute user tests among the particular operating conditions. Particularly no liability for media compatibility may be derived out of it.

mineral oil		usable without restriction
HFA	oil-in-water emulsion	consultation required
HFB	water-in-oil emulsion	consultation required
HFC	aqueous solution (glycols)	consultation required
HFD	anhydrous fluids (Phosphor-Ester)	consultation required

 For detailed information concerning pressure fluids note VDMA-document 24317 as well as DIN 51524 & 51502.

Special gaskets may be available depending on the utilized fluid.
In case of insecurity please consult the factory.

Electrical Connection

The electrical connection of the valve takes place by one common cable, which is coupled to the integrated electronic driver by a central connector assembly.

The connection Code 0 as well as Code 7 requires a 6 + PE female connector EN 175201-804.

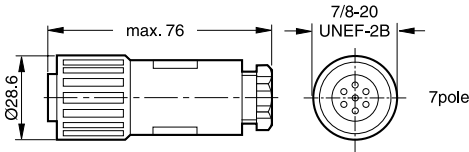

☞ The female connector has to be ordered separately under article nr. 5004072.

⚠ A female connector with metal housing is required! Plastic made models may create function problems due to insufficient EMC-characteristics.

The connecting cable has to comply to the following specification:

Cable type	control cable, flexible, 7 conductors, overall braid shield
Cross section	min. AWG16
Outer dimension	8...12 mm
Cable length	max. 50 m

☞ For cable lengths > 50 m consult factory.

The connection cable is coupled to the female connector by solder joints.

Skinning lengths for the connecting cable:

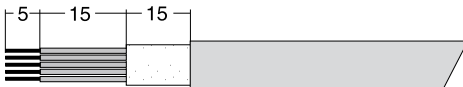

The connection Code 5 requires a 11 + PE female connector EN 175201-804.

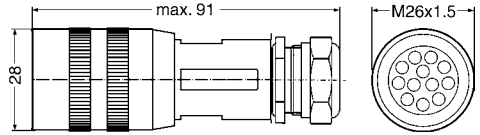

☞ The female connector has to be ordered separately under article nr. 5004711.

⚠ A female connector with metal housing is required! Plastic made models may create function problems due to insufficient EMC-characteristics.

The connecting cable has to comply to the following specification:

Cable type	control cable, flexible, 8 conductors, overall braid shield
Cross section	min. AWG16
Outer dimension	12...15 mm
Cable length	max. 50 m

☞ For cable lengths > 50 m consult factory.

The connection cable is coupled to the female connector by crimp contacts.

Skinning lengths for the connecting cable:



☞ For the workmanlike termination of the crimp contacts the tool # 932 507-001 – supplier: Hirschmann – is required.

⚠ Do not disconnect cable socket under tension!

The shielding has to be assembled according the outline below:

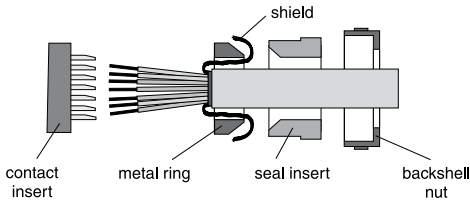

The backshell nut of the cable gland has to be tightened with a suitable tool. The target value for the tightening torque is 4 Nm. Tighten the cap nut with a torque of approx. 5 Nm after attaching the female connector on the socket outlet.

⚠ Incomplete tightening of backshell nut resp. cap nut may result in automatic release of the connection as well as degradation of the water tightness. Follow the "instructions for use" for installation of female connectors made by other kind of brands!

⚠ The cable connection to the female connector has to take place by qualified personnel! A short between individual conductors resp. to the connector housing, bad soldering as well as improper shield connection may result in malfunction and breakdown of the valve.

⚠ The mounting surface of the valve has to be carefully tied to the earth grounded machine frame. The earth ground wire from the valve connecting cable as well as the cable shield have to be tied to the protective earth terminal within the control unit. It is necessary to use a low ohmic potential connection between control unit and machine frame to prevent earth loops (cross section AWG 6).

Electrical Interfacing

Supply Voltage:

The supply voltage for the valve has to cover the range of 22...30 V. The residual ripple may not exceed 5% eff.

⚠ The applied power supply must comply to the relevant regulations (DIN EN 61558) and must carry a CE-mark. The operating voltage for the valve must be free of inductive surges. Do not exceed the max. value of 30V! Non-observance of this rule may result in permanent damaging of the valve.

⚠ The increased inrush current of the valve should be considered when selecting the power supply. A stabilized power supply with overcurrent limiting feature should not be used. Due to the inrush current of the valve the current limit circuit may respond prematurely and create problems during energizing of the supply voltage.

⚠ The operation of the valve is blocked if the supply voltage polarity is interchanged.

⚠ Each valve requires a separate pre-fuse of 4 Amp time lag. Non-observance of this instruction may create irreparable damage of valve resp. incorporated system parts.

Wiring diagram of supply voltage

Code 0 (6 + PE)

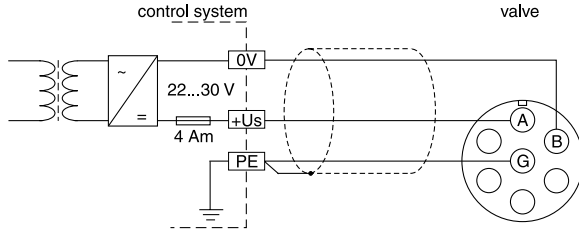

Code 5 (11 + PE)

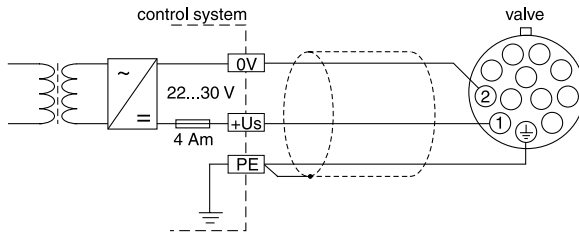

Code 7 (6 + PE)

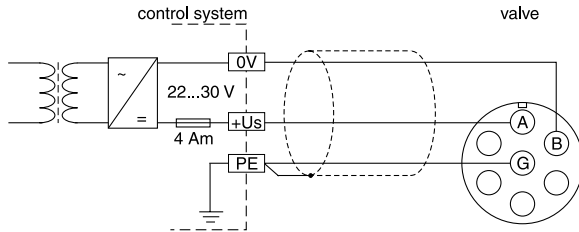

Enable input (only for Code 5 / 11+PE as well as Code 7 / 6+PE)

A signal voltage enables the actuator drive of the valve. Continuous operation of the valve requires a permanent voltage 5...30V (i.e. the supply voltage). In case of disabling the signal the valve will reach its hydraulic default (fail safe) position in no time independently from the command signal value. At the same time the position controller output will be clamped. In case of restarting the enable signal, the valve spool takes its position always out of the fail safe position. Preferable the enable signal should be switched on together with the hydraulic pressure

supply. This forces the actuator drive into drop out condition when the hydraulic system is switched off, and it avoids needless heating of the actuator.



The enable function represents no safety arrangement against unwanted valve operation in terms of rules for accident prevention! To block the valve function under all conditions, more advanced steps are necessary, i.e. the installation of additional safety check valves.

Wiring diagram of enable input

Code 5 (11 + PE)

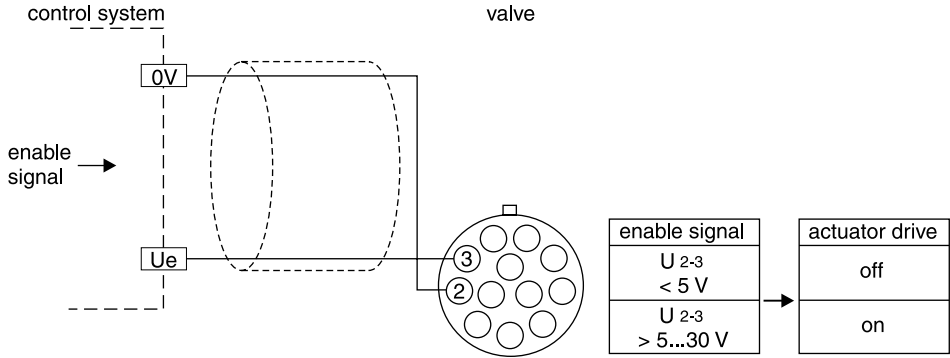

Code 7 (6+PE)

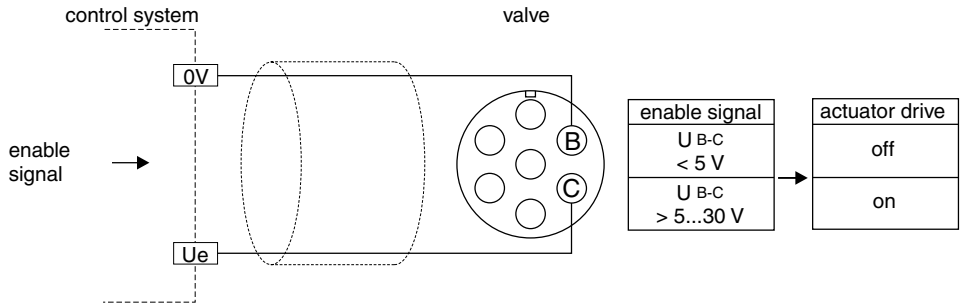

Command signal input:

The command signal for the valve will be connected to the pins D and E of the difference signal input of the electronic driver. The spool stroke behaves proportional to the command signal amplitude. Different versions of command signal processing are available, depending on the valve type. These are described below:

For the function description is assumed as signal reference (0V):

Code 0: pin E, Code 5: pin 5, Code 7: pin E





Details are shown from the technical specifications.



The command input signal needs to be filtered as well as free of inductive surges and modulations. Due to the sensitivity of the valve a high signal quality is recommended, this will prevent malfunction.

Operation Manual

 Incorrect signal amplitude levels may disturb the functionality and can damage the valve.

 The option 4...20 mA uses the “0 mA” condition as breakdown-information. This means the presence of an evaluable failure information if the input signal line is interrupted. In this case the actuator drive will be switched off.

The drive will switch on when the input signal reaches a value of 3.8 mA, it switches off when the command falls below 3.6 mA. This determination follows the NAMUR-specification NE43.

NAMUR is an association of users of process control technology.

**Wiring diagram of voltage command input +10...0...-10 V
 Code 0 (6 + PE)**

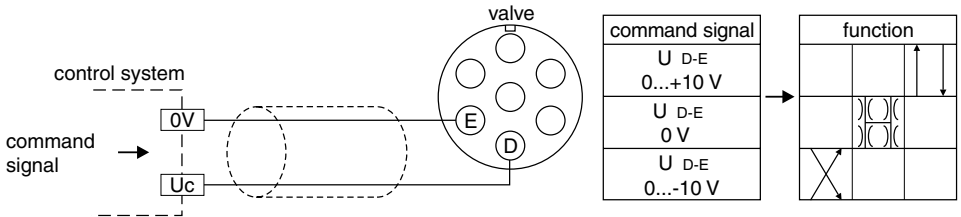

**Wiring diagram of voltage command input +10...0...-10 V
 Code 5 (11 + PE)**

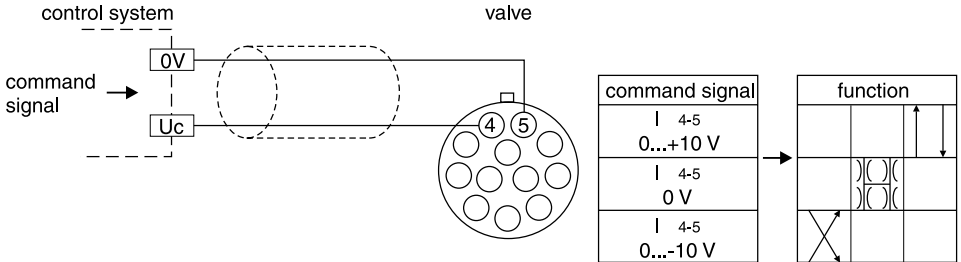

**Wiring diagram of voltage command input +10...0...-10 V
 Code 7 (6 + PE)**

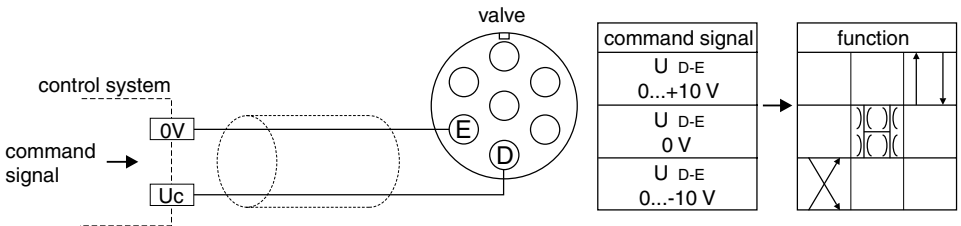

Operation Manual

Wiring diagram of current command input 4...12...20 mA

Code 0 (6 + PE)

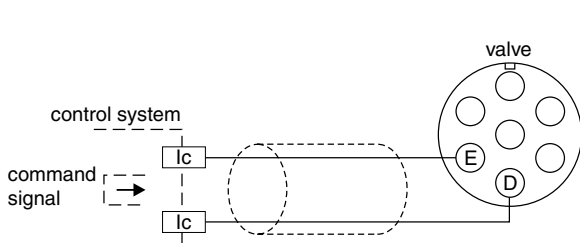

command signal	function
I _{D-E} 12...20 mA	
I _{D-E} 12 mA	
I _{D-E} 4...12 mA	
I _{D-E} < 3.6 mA	actuator drive off
I _{D-E} > 3.8 mA	actuator drive on

Wiring diagram of current command input 4...12...20 mA

Code 5 (11 + PE)

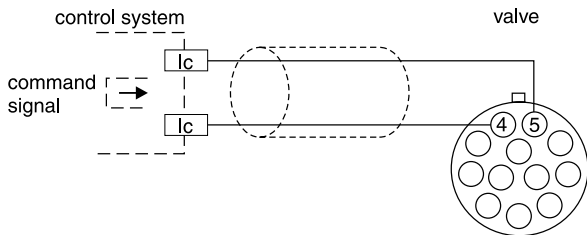

command signal	function
I ₄₋₅ 12...20 mA	
I ₄₋₅ 12 mA	
I ₄₋₅ 4...12 mA	
I ₄₋₅ < 3.6 mA	actuator drive off
I ₄₋₅ > 3.8 mA	actuator drive on

Wiring diagram of current command input 4...12...20 mA

Code 7 (6 + PE)

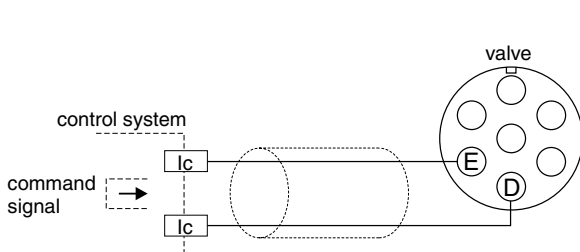

command signal	function
I _{D-E} 12...20 mA	
I _{D-E} 12 mA	
I _{D-E} 4...12 mA	
I _{D-E} < 3.6 mA	actuator drive off
I _{D-E} > 3.8 mA	actuator drive on

Diagnostics output:

A diagnostics signal is available. Its voltage represents the operating condition of the valve.

The following information is available:

- position of valve spool (+10...0...-10 V means +100...0...-100 % spool stroke).

- status of the actuator drive (supply voltage level +22...30 V for disconnected drive due to overload condition).

⚠ The output may drive a load of max. 5 mA. Exceeding of this limit leads to malfunction.

Wiring diagram of diagnostics output Code 0 (6 + PE)

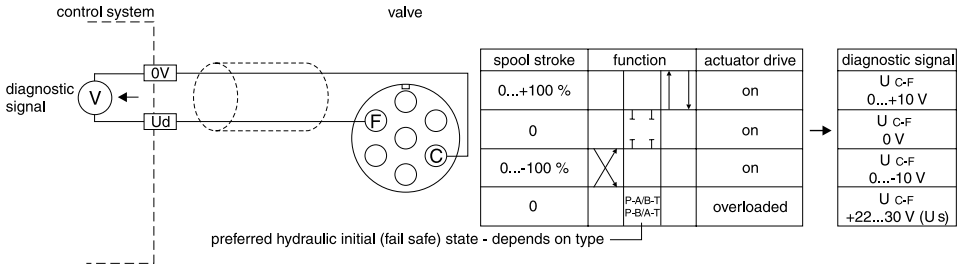

Wiring diagram of diagnostics output Code 5 (11 + PE)

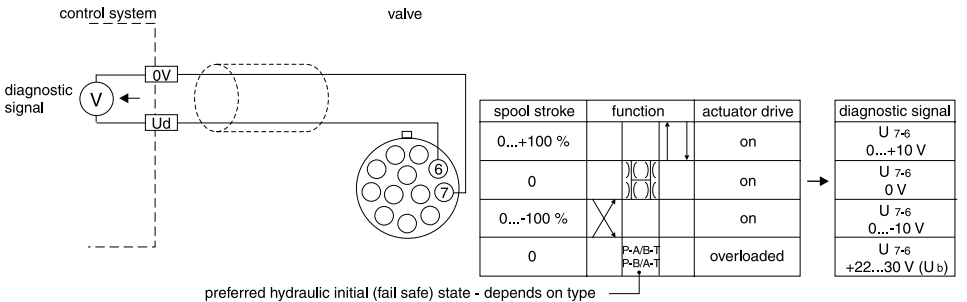

Wiring diagram of diagnostics output Code 7 (6 + PE)

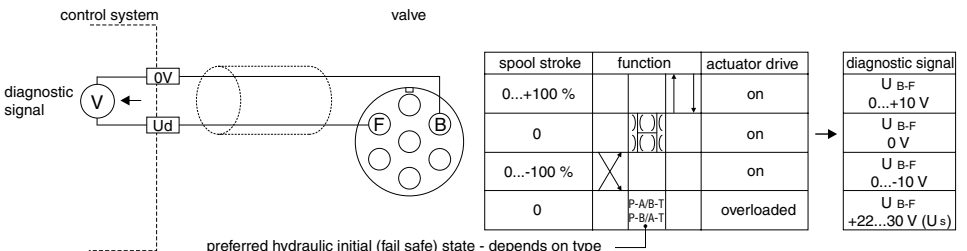

5. Operating Instructions

Basically the valve performs the task of converting a command signal into a proportional spool stroke with the highest possible dynamic. For these purposes the input value will be electronically compared with the actual spool position value. The signal difference feeds a position controller, that in turn provides via a power amplifier stage the required current for the actuator of the pilot stage.

Preferred Hydraulic Initial State



Valve versions with zero lap spool have no safe initial state when switched off. In this case the valve takes a position which is selectable by the valve type (preferred hydraulic initial state). This position depends on contamination level and therefore is not ensured. We would therefore recommend the application of additional check valves with sequential control.

Solenoid Current Monitoring

The electronic driver contains a circuit to monitor the solenoid current. The current measurement compares for exceeding of a certain value and switches off after a time period of approx. 10 sec. for temperature rise protection of the actuator. For normal operating conditions this state will not be reached, but it may occur with a contaminated sluggish valve.



In this case the reason for the contamination should be repaired (hydraulic fluid exchange, filtration review, valve flushing).

The overcurrent shutoff condition may be reset by the actions below:

Code 0: Temporary disconnection of the supply voltage.

Code 5: Temporary disconnection of the enable signal.

Code 7: Temporary disconnection of the enable signal.



The shutoff of the actuator drive due to overload will be signaled via the diagnostics output.

The condensed function conditions of the actuator drive are given below:

The actuator drive is enabled, if:

the actuator drive is in normal operation, AND current of > 3.8 mA flows into input (4...20 mA option)

The actuator drive is disabled, if:

the actuator drive is in overload operation, OR current of < 3.6 mA flows into input (4...20 mA option)

Air Bleeding of Hydraulic System

During initial startup, after an oil change as well as after the opening of lines or valves the hydraulic system must be air bled. Air in the hydraulic system is very disadvantageous and therefore undesirable for the control system. The pipeline network is vented at its highest point. The fitting may be loosened a little so that the air can escape with only a small amount of oil loss. When the oil is no longer foaming, the fitting is re-tightened. Afterwards all functions are run through, one after the other, in no-load operation with low pressure and with full cylinder stroke. Afterwards the system should be vented once more.



After air bleeding the oil level in the tank must be checked, and refilled as necessary!

Filter

The function and lifetime of the valve are strongly affected by the cleanliness of the fluid.



Dirt is the greatest enemy of the hydraulic system!

There are three important sources of dirt to watch for:

- contamination arising during installation
- contamination arising during operation, friction wear
- impurities from the environment

Basically a purity level class of 7 acc. NAS 1638 is required.



Pay attention to maintenance details!

Flushing

It is recommended to flush the long pipelines by short circuiting the pressure and return lines, especially for large, central pressure oil stations. This prevents the installation dirt from entering the valve.

8. Accessories / Spare Parts

Accessories

The following accessories are available for the valve series DF Plus pilot operated:

- D31FP:
Bolt kit ordering code BK385
- Code 0:
female connector 6+PE ordering code 5004072
- Code 5:
female connector 11-PE ordering code 5004711
- Code 7:
female connector ordering code 5004072
- D41FP:
Bolt kit ordering code BK320
- Code 0:
female connector 6+PE ordering code 5004072
- Code 5:
female connector 11-PE ordering code 5004711
- Code 7:
female connector ordering code 5004072
- D81/91FP:
Bolt kit ordering code BK360
- Code 0:
female connector 6+PE ordering code 5004072
- Code 5:
female connector 11-PE ordering code 5004711
- Code 7:
female connector ordering code 5004072
- D111FP:
Bolt kit ordering code BK386
- Code 0:
female connector 6+PE ordering code 5004072
- Code 5: f
emale connector 11-PE ordering code 5004711
- Code 7:
female connector ordering code 5004072

Spare Parts

The following spare parts are available:

- D31FP:
Seal kit NBR ordering code SK-D31FP
- D41FP:
Seal kit NBR ordering code SK-D41FP
- D81FP:
Seal kit NBR ordering code SK-D81FP
- D91FP:
Seal kit NBR ordering code SK-D91FP
- D111FP:
Seal kit NBR ordering code SK-D111FP

Please direct technical product enquiries to:

**Parker Hannifin
Manufacturing Germany GmbH & Co. KG**
Hydraulic Controls Division Europe
Gutenbergstr. 38
41564 Kaarst, Germany
Tel.: (+49) 181 99 44 43 0
E-mail: infohcd@parker.com

Hotline in Europe
Phone: 00800-2727-5374