



aerospace
climate control
electromechanical
filtration
fluid & gas handling
hydraulics
pneumatics
process control
sealing & shielding



Redefining Spray Technology

Macro spray® Single-Point Nozzles

Macro spray® Spider Nozzles



ENGINEERING YOUR SUCCESS.

Macropray® nozzle technology

Improved performance, lower cost

Macropray® nozzle technology from Parker Hannifin's Gas Turbine Fuel Systems Division is a revolutionary new way to think about spray applications and spray systems. Proprietary macrolamination technology — where numerous layers are joined using advanced production methods to create a macrolaminate stack — not only simplifies nozzle design, it results in enhanced performance at substantially reduced installation and life-cycle costs.

Smaller drop size.

Using hydraulic pressure only, Macropray technology enables the production of very fine atomized sprays. Nozzle passages, including metering slots, spin chambers, and exit orifices, are designed to minimize pressure drop, resulting in conservation of mechanical or pressure energy up to the exit orifice.

By applying sound fluid mechanics principles, Macropray products maximize the energy available for atomization of the fluid. This leads to an efficient breakup of the hollow-cone spray, resulting in excellent circumferential uniformity of droplet size.

Lower operating pressure.

When compared to conventionally manufactured nozzles, Macropray nozzles develop useful sprays at substantially reduced pressures. Fluid flow-channel volumes are optimized to produce cleaner, faster startups and shutdowns of the spray, virtually eliminating “nozzle drool.”

Robust and reproducible designs every time.

Macropray nozzles are produced from digital masters with very tight tolerances on flow channel features. Advanced production methods, including digital tooling and chemical machining, result in a robust process with minimum variability. Once the design is developed, production process variables are locked, and the design can be reproduced every time with minimum effort.

Multiple injection points.

When higher flow rates, fine drop size, and uniformity of spray patterns are required, multiple-injection-point nozzles are the right choice. Integral manifolding can also be developed as part of the macrolaminate stack, optimizing spray performance, use of space, and reduced costs.

Less maintenance.

Because nozzle plugging can be a problem in any spray application, each Macropray nozzle has an integrated filter layer in the macrolaminate stack. An optional removable filter can also be fitted to provide longer life.

Design flexibility – complete system availability.

Macropray nozzles can be designed to integrate into almost any structure or housing, in a wide range of spray configurations. Because all tooling is digital, custom products are possible. Controls, sensors, pumps, and packaging can be incorporated into an entire spray system solution when needed.

Highly complex fluid paths are possible with Macropray nozzles.

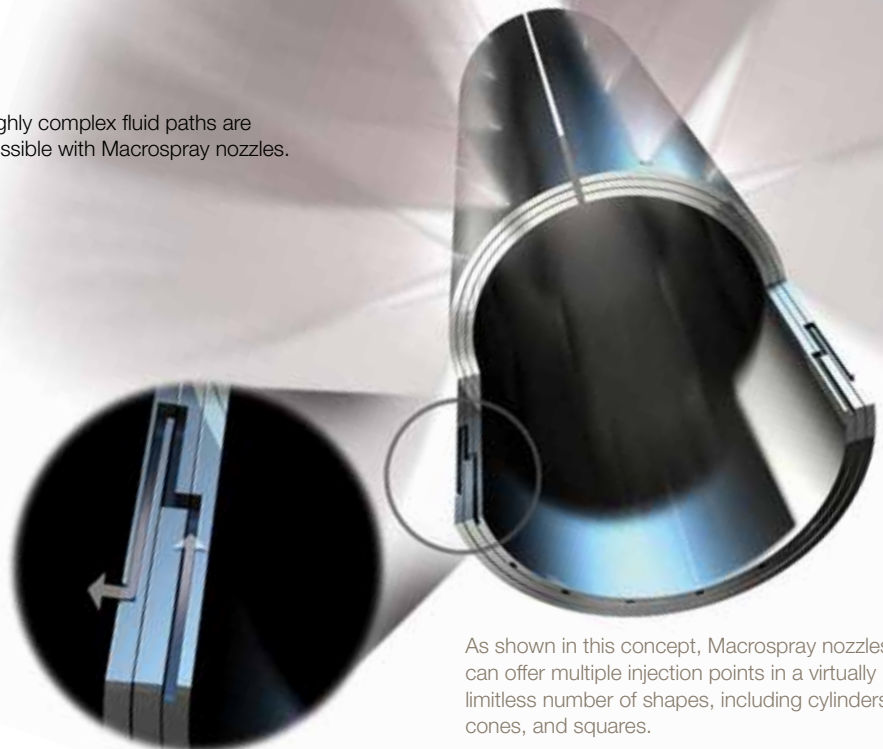

As shown in this concept, Macropray nozzles can offer multiple injection points in a virtually limitless number of shapes, including cylinders, cones, and squares.

Macrospray® technology enables atomization devices that better disperse fluids.



Why Parker?

Parker's Gas Turbine Fuel Systems Division has the talent, resources, and infrastructure to develop new and customized Macrospray nozzles and systems quickly and cost effectively. We have decades of expertise in liquid atomization for highly critical aerospace applications, and many other industries find this broad range of knowledge and experience invaluable in addressing their requirements for

exceptional liquid atomization and overall spray performance.

Our technology database of proven products and processes affords us greater flexibility in developing customized solutions to meet present and future market demands. And we take a partnership approach, with a dedicated global organization that offers you unparalleled support, with no exceptions.

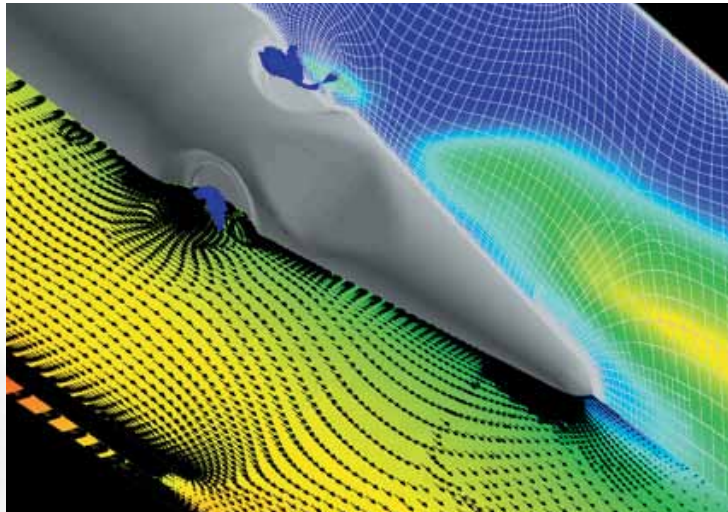

Computational fluid dynamics confirms detailed design requirements.

Current injector geometries

- Cylinders
- Cones
- Rings
- Spray matrices
- Tubes
- Bars
- Plates
- Spiders



Fuel cell cooling system

Macrospray applications

- Advanced liquid cooling
- Electronics cooling
- Humidification
- Turbine inlet air cooling
- Chemical processing
- Micro power generation
- Fuel cells
- Gas conditioning
- Burners
- Emissions control
- Fire suppression
- Snow making
- Dust control
- Livestock cooling
- Food processing
- Pest control
- Pharmaceuticals
- Odor control
- And more

The technology behind macrolamination

A Parker design innovation, macrolamination technology utilizes digital tooling for precise placement of critical geometries essential for good spray performance. These geometries are chemically machined into layers that provide



Macrolaminated sheet from Macrospray nozzle production.

smooth, efficient flow passages, and also allow complex or multiple flow circuits to be produced at little cost. The layers are then bonded together, forming a monolithic structure with the bonded joints as strong as the parent material.



Macrospray technology makes single nozzle or complex nozzle arrays possible. Left, a circuit board spray cap has 20 precisely located coolant injection points. The injection points have different flow rates to control the coolant flow rate to specific parts of the mating chips (not shown).



Industrial gas turbine nozzle

Macropray single-point nozzles:

The perfect replacement nozzles

Designed to replace conventional pressure-swirl and impact-type nozzles, Macropray single-point nozzles offer **smaller droplets, repeatable droplet dispersion patterns, and more uniform spray patterns.**



Other Macropray benefits:

- Better performance at lower pressures than conventional pressure-swirl or impact-type nozzles
- Lower operating pressures for reduced nozzle erosion and longer nozzle life
- Larger flow passages than impact-type nozzles for reduced plugging
- Smaller packages than conventional nozzles for hard-to-reach applications
- More robust and consistent performance over the life of the nozzle
- Integral filter for reduced maintenance and longer life
- Available in a wide range of flow capacities, and multiple mounting configurations
- Easy replacement of existing impact and pressure-swirl nozzles



Macropray single-point nozzles generate droplets less than 15μ (SMD) at 600 PSI pressure.

Typical single-point applications

- Turbine inlet air cooling (TIAC)
- Gas conditioning
- Gas cooling
- Humidification
- Moisturizing
- Odor control
- And more

Systems and accessories

- Manifolds, standard and custom
- Nozzle and manifold kitting
- Filtration
- Mounting bosses

Mounting bosses – Available in a variety of configurations to match standard piping. When ordering, please specify the threaded connection type along with the piping and schedule size with which the mounting bosses are to be used.

Maximum pressure – Maximum operating pressure at ambient temperature is 3000 PSI.

Temperature statement – Catalog nozzles have a maximum liquid operating temperature of $+176^{\circ}\text{F}$ ($+80^{\circ}\text{C}$). For applications above this temperature, please contact us at (440) 266-2300.

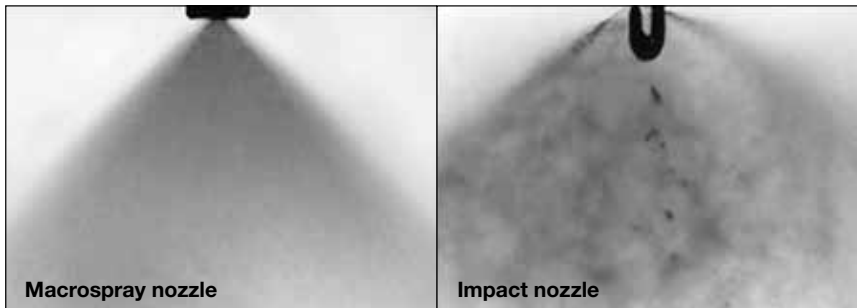

Macropray nozzle

Impact nozzle

Both nozzles above are operating at 500 PSI. The capacity for the Macropray nozzle is 3.6 GPH, while the impact nozzle produces 3.3 GPH. The spray pattern from the Macropray is uniform, consisting of finely atomized droplets essential for good evaporation. In contrast, the impact nozzle's spray pattern is marked with voids and large rogue droplets.

Ordering and technical information

Please specify the following when ordering: nozzle type, capacity, and connection type. All single-point nozzles are SP type.

Example:

SP **2.0** **S1**
 Nozzle type Capacity Connection type

Three standard connections available

N 1/4 NPT (male) • N1 1/8 NPT (male) • S1 3/8-24 UNF (male)

Other connection types and sizes are available upon request.

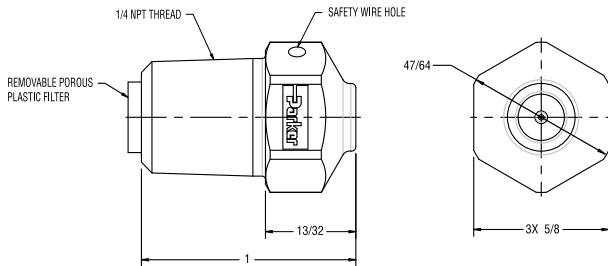
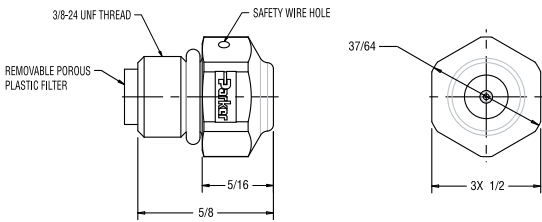
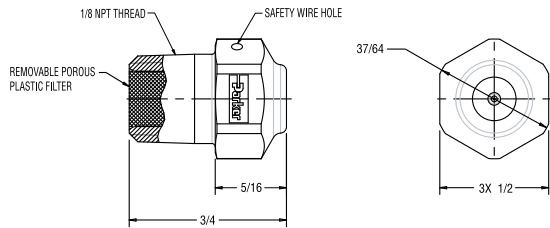

Dimensions are given in inches unless otherwise specified.

For additional information or to place an order, please call (440) 266-2300 or e-mail macropray@parker.com. Visa and MasterCard accepted.

Single-point nozzle capacity, U.S. GPH (water)

Approximate values

Capacity	100 psi	200 psi	300 psi	400 psi	500 psi	750 psi	1000 psi
0.5	0.50	0.71	0.87	1.00	1.12	1.37	1.58
0.6	0.60	0.85	1.04	1.20	1.34	1.64	1.9
1.0	1.0	1.4	1.7	2.0	2.2	2.7	3.2
1.5	1.5	2.1	2.6	3.0	3.4	4.1	4.7
2.0	2.0	2.8	3.5	4.0	4.5	5.4	6.3
2.5	2.5	3.5	4.3	5.0	5.6	6.9	7.9
3.0	3.0	4.2	5.2	6.0	6.7	8.2	9.5
3.5	3.5	5.0	6.1	7.0	7.8	9.6	11.1
5.0*	5.0	7.1	8.7	10.0	11.2	13.7	15.8
6.5*	6.5	9.2	11.3	13.0	14.5	17.8	20.6
8.0*	8.0	11.3	13.9	16.0	17.9	21.9	25.3

* These capacities are not available with 3/8-24 threads or 1/8 NPT threads. For items not listed, please call.

Different flow values can be developed upon request.

The following can be used to estimate flows where pressure is not indicated:

$$\frac{\text{GPH}_1}{\text{GPH}_2} = \frac{\sqrt{\text{PSI}_1}}{\sqrt{\text{PSI}_2}}$$

Example:
 $\frac{x}{0.5 \text{ GPH}} = \frac{\sqrt{1300 \text{ PSI}_1}}{\sqrt{100 \text{ PSI}_2}}$

Filtration

Removable filters are included.

Drop size

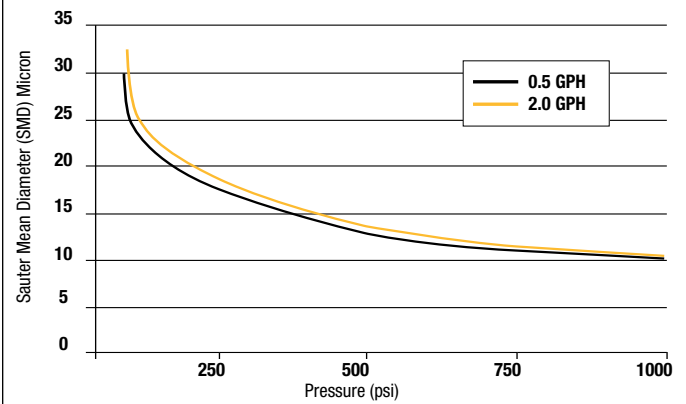

The figure above shows the droplet size generated by a spray emanating from two different capacity nozzles. The droplet size data was obtained with a laser diffraction instrument. The line-of-sight measurements were made at an axial location two inches downstream from the nozzle exit. This figure shows that the droplet size is highly dependent on liquid injection pressure where the SMD (Sauter Mean Diameter) is proportional to $\Delta p^{-0.38}$ (i.e., $\text{SMD} \sim \Delta p^{-0.38}$).

Macropray spider nozzles:

More spray points for better coverage

Because spider nozzles utilize two, four, six, eight, or twelve spray points per assembly, they are able to provide a much larger coverage area than conventional pressure-swirl or impact-type nozzles. This translates into fewer

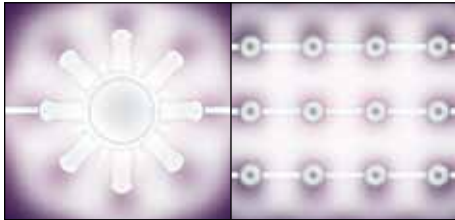

A single spider nozzle installation can replace a number of single-point nozzles, substantially reducing piping manifold costs.

bosses and less piping, resulting in quicker installation, lighter weight, and lower installation and maintenance costs. Multiple injection point nozzles not only provide superior spray performance, but,

with significantly higher flow rates, are ideal for applications where higher volumes of liquid with fine drop sizes are required.



Parker spider nozzle benefits:

- Geometries are chemically machined into layers providing smooth, efficient flow passages, which allow for complex or multiple flow circuits
- Extremely fine spray with smaller droplets than conventional pressure-swirl designs or impact-type nozzles
- Lower operating pressures than impact-type or conventional pressure-swirl nozzles provide sharper startups and shutdowns of the spray
- Lower pressure reduces erosion effects on critical geometries
- Increasing the total flow rate of a nozzle, by increasing the number of injection points or legs, will not result in any significant change in droplet size
- Larger fluid passages in smaller packages than impact-type nozzles
- More robust and consistent performance over the life of the nozzle
- Faster change-out than conventional nozzles, reducing system downtime and contributing to lower life-cycle costs

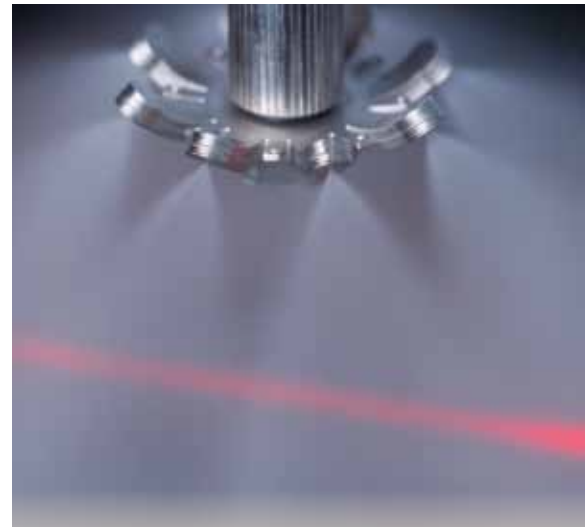

Macropray nozzles generate droplets less than 15 μ (SMD) at 600 PSI pressure.

Typical spider nozzle applications

- Turbine inlet
- Fire suppression
- air cooling (TIAC)
- Odor control
- Gas conditioning
- And more
- Gas cooling

Systems and accessories

- Manifolds, standard and custom
- Nozzle and manifold kitting
- Filtration
- Mounting bosses

Mounting bosses – Available in a variety of configurations to match standard piping. When ordering, please specify the threaded connection type along with the piping and schedule size with which the mounting bosses are to be used.



Maximum pressure – Maximum operating pressure at ambient temperature is 3000 PSI.

Ordering and technical information

Please specify the following when ordering: nozzle type, number of legs, capacity per spray point/leg, angle of leg, and connection type. All spider nozzles are MS type.

Example:

MS - **8** - **2.0** - **45** - **S**
 Nozzle type - Number of legs - Capacity per spray point/leg - Angle of leg - Connection type

Three angles and three connection types available

Angle of legs (Θ)		
0°	22-1/2°	45°
Connections		
S 1/2-20 UNF (male)	S1 3/8-24 UNF (male)	N 1/4 NPT (male)
Other connection types and sizes are available upon request.		

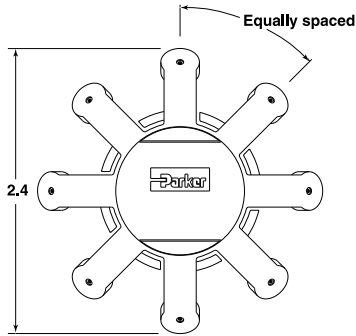
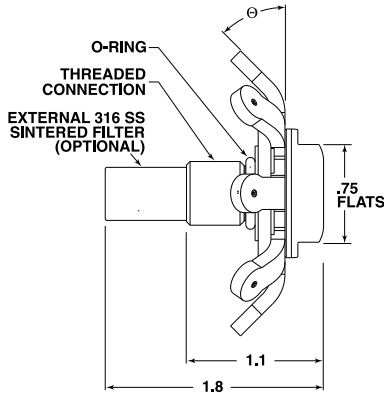

Dimensions are given in inches unless otherwise specified.
 O-ring is used with straight threads only.

Spider nozzle capacity per leg, U.S. GPH (water)

Approximate values

Capacity	100 psi	200 psi	300 psi	400 psi	500 psi	750 psi	1000 psi
0.5	0.50	0.71	0.87	1.00	1.12	1.37	1.58
1.0	1.0	1.4	1.7	2.0	2.2	2.7	3.2
1.5	1.5	2.1	2.6	3.0	3.4	4.1	4.7
2.0	2.0	2.8	3.5	4.0	4.5	5.4	6.3
2.5	2.5	3.5	4.3	5.0	5.6	6.9	7.9
3.0	3.0	4.2	5.2	6.0	6.7	8.2	9.5

Different flow values can be developed upon request.

The following can be used to estimate flows where pressure is not indicated:

Example:

$$\frac{\text{GPH}_1}{\text{GPH}_2} = \frac{\sqrt{\text{PSI}_1}}{\sqrt{\text{PSI}_2}} \quad \times \quad \frac{0.5 \text{ GPH}}{\sqrt{100 \text{ PSI}_2}} = \frac{\sqrt{1300 \text{ PSI}_1}}{\sqrt{100 \text{ PSI}_2}}$$

External Filters

External filters are available upon request.

Drop size

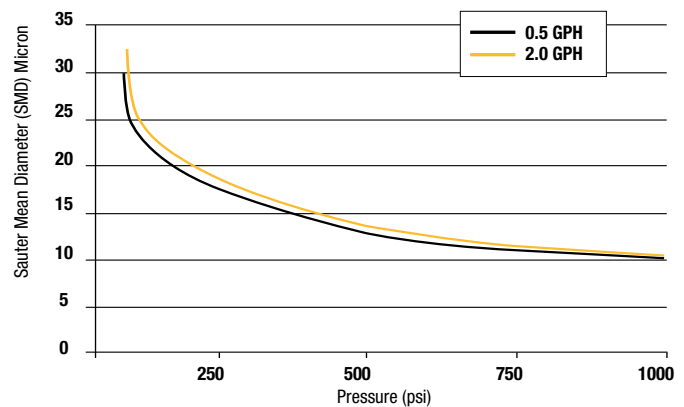

The figure above shows droplet size generated by one spider leg with the remaining legs closed off. The spray performance geometries for the spiders are the same as for the single-point nozzles. The values shown were measured from two different capacity nozzles. The droplet size data was obtained with a laser diffraction instrument. The line-of-sight measurements were made at an axial location two inches downstream from the nozzle exit. This figure shows that the droplet size is highly dependent on liquid injection pressure where the SMD (Sauter Mean Diameter) is proportional to $\Delta p^{0.33}$ (i.e., $\text{SMD} \sim \Delta p^{0.33}$).

For additional information or to place an order, please call (440) 266-2300 or e-mail macropray@parker.com. Visa and MasterCard accepted.



Parker Hannifin Corporation
Gas Turbine Fuel Systems Division
8940 Tyler Boulevard
Mentor, OH 44060 U.S.A.
phone 440 266 2300
fax 440 266 2402
e-mail: macrospray@parker.com
www.parker.com