

# Installation IQAN-TOC8

Publ.no: M5010024A  
Ed. A

IQAN-TOC8

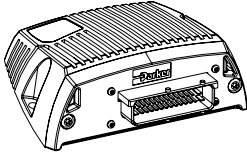

valves

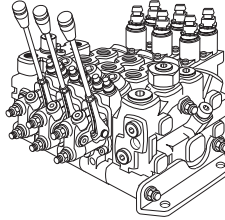

levers, switches  
and sensors

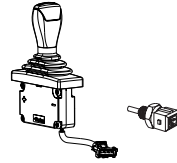

It is required to download the operating system vmAC before using the controller.

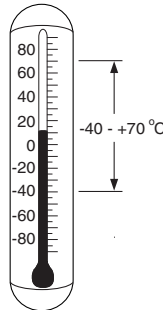
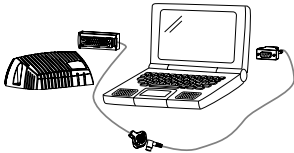

**CE**  
(89/336/EEC)

For further information see:  
HY17-8375 Instructions IQAN-TOC8

# Wiring diagram

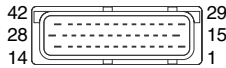
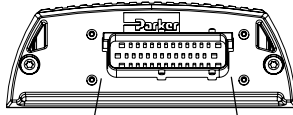

1	not used	15	-BAT	29	-BAT2
2	+VREF-A	16	CAN-H (J1939)	30	CAN-L (J1939)
3	VIN-A/FIN-A	17	COU-A+	31	COU-A-
4	-VREF-A	18	CRET-A+	32	CRET-A-
5	VIN-E	19	COU-B	33	COU-B-
6	VIN-B/FIN-B	20	CRET-B+	34	CRET-B-
7	VIN-F	21	DOUT-A/PWMOUT-A	35	DOUT-C/PWMOUT-C
8	VIN-G	22	DOUT-B/PWMOUT-B	36	DOUT-D/PWMOUT-D
9	VIN-C/FIN-C	23	DOUT-E/PWMOUT-E	37	ALARM
10	VIN-H	24	DOUT-F/PWMOUT-F	38	GND (DATA)
11	+VREF-B	25	DATA-OUT	39	READY-OUT
12	VIN-D/FIN-D	26	DATA-IN	40	BSL-IN
13	-VREF-B	27	VIN-I	41	VIN-J
14	not used	28	+BAT(+12V, +24V)	42	+BAT2(+12V, +24V)

Mating connector kit: 5031 063

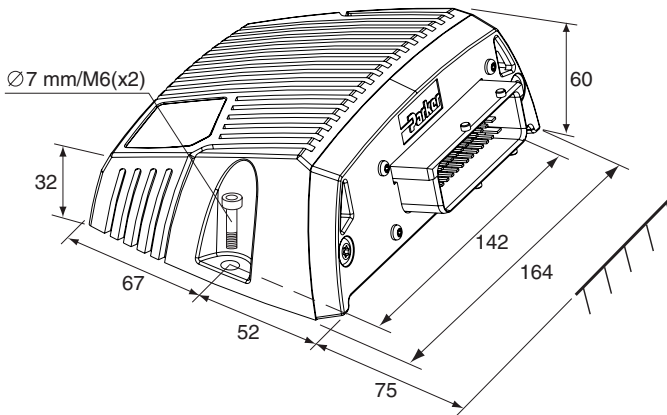

unit = mm