



DC Drives

DC590+ Product Catalog



ENGINEERING YOUR SUCCESS.



Parker Electromechanical and Drives Division Headquarters - Charlotte, NC

WARNING - USER RESPONSIBILITY

FAILURE OR IMPROPER SELECTION OR IMPROPER USE OF THE PRODUCTS DESCRIBED HEREIN OR RELATED ITEMS CAN CAUSE DEATH, PERSONAL INJURY AND PROPERTY DAMAGE.

This document and other information from Parker Hannifin Corporation, its subsidiaries and authorized distributors provide product or system options for further investigation by users having technical expertise.

The user, through its own analysis and testing, is solely responsible for making the final selection of the system and components and assuring that all performance, endurance, maintenance, safety and warning requirements of the application are met. The user must analyze all aspects of the application, follow applicable industry standards, and follow the information concerning the product in the current product catalog and in any other materials provided from Parker or its subsidiaries or authorized distributors.

To the extent that Parker or its subsidiaries or authorized distributors provide component or system options based upon data or specifications provided by the user, the user is responsible for determining that such data and specifications are suitable and sufficient for all applications and reasonably foreseeable uses of the components or systems.

OFFER OF SALE

The items described in this document are hereby offered for sale by Parker Hannifin Corporation, its subsidiaries or its authorized distributors. This offer and its acceptance by the provisions stated in the detailed 'Offer of Sale' which is available upon request.

Table of Contents

	Page
DC590+ General Description	5
Features and Benefits	6
DRV Version	7
Technical Specifications	8
Mechanical Overview	9
Electrical Characteristics	13
Accessories and Options	14
Programming software tools for all drives	18
Systems	19
External Stack Controller	20
Applications	22



Parker Hannifin

The global leader in motion and control technologies and systems

Global Partnerships Global Support

Parker is committed to helping make our customers more productive and more profitable through our global offering of motion and control products and systems. In an increasingly competitive global economy, we seek to develop customer relationships as technology partnerships. Working closely with our customers, we can ensure the best selection of technologies to suit the needs of our customers' applications.

Electromechanical Technologies for High Dynamic Performance and Precision Motion

Parker electromechanical technologies form an important part of Parker's global motion and control offering. Electromechanical systems combine high performance speed and position control with the flexibility to adapt the systems to the rapidly changing needs of the industries we serve.

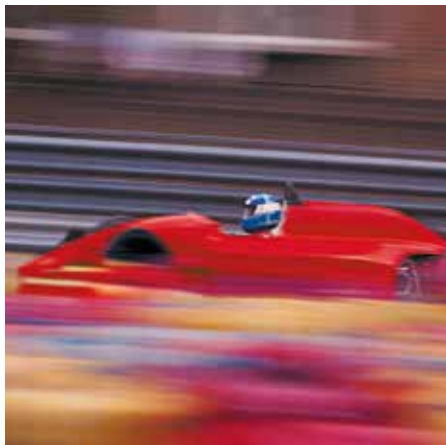

About Parker Hannifin Corporation

With annual sales of approximately \$13 billion in fiscal year 2015, Parker Hannifin is the world's leading diversified manufacturer of motion and control technologies and systems, providing precision-engineered solutions for a wide variety of mobile, industrial and aerospace markets. The company employs approximately 55,000 people in 50 countries around

the world. Parker has increased its annual dividends paid to shareholders for 59 consecutive fiscal years, among the top five longest-running dividend-increase records in the S&P 500 index. For more information, visit the company's web site at <http://www.parker.com>, or its investor information site at <http://www.phstock.com>



Call us:
(704) 588-3246
Email us:
info.us.ssd@parker.com



DC Drives - DC590+ Integrator Series

1 HP – 1200 HP



Common programming, set-up and communications platform with AC690+ AC Integrator Series

Ratings up to 1200 HP (1950 Amps) and supply voltages to 690V, non-regenerative and regenerative models

Internal controlled field supply

Function block programming, including open and closed-loop winder control as standard

DRV style includes built-in contactor, fuses and provision for on-board control transformer and blower starter

Description

Building upon Parker's 40 years of DC drive experience, the DC590+ Integrator Series drive takes DC motor control to the next level. With 32-bit control architecture, the DC590+ drive delivers highly functional and flexible control suited to a whole host of industrial applications.

Typical Applications

- **Converting machinery**
- **Plastics and rubber processing machinery**
- **Wire and cable**
- **Material handling systems**
- **Automotive**

Programming

Featuring an intuitive menu structure, the ergonomically designed operator panel allows quick and easy access to all parameters and functions of the drive via a bright, easy to read backlit display and tactile keypad. Additionally, it provides local control of start/stop, speed demand and rotation direction to greatly assist with machine commissioning.

- **Multi-Lingual alpha-numeric display**
- **Customized parameter values and legends**
- **On drive or remote mounting**
- **Local control of start/stop, speed and direction**
- **Quick set-up menu**

Interface Options

The DC590+ has options to accept most common feedback devices. Armature voltage feedback is standard

For connectivity, a number of communications and I/O options allow the drive to take control of the application, or be integrated into a larger system. Custom functions and control can be easily created resulting in a highly flexible and versatile platform for DC motor control.

Function Blocks

Function Block Programming is a flexible control structure that allows an almost infinite combination of user functions to be realized with ease. Each control function (an input, output, process PID for example) is represented as a software block that can be freely interconnected to all other blocks to provide any desired action. The drive is shipped with the function blocks pre-configured as a standard DC drive so you can operate it straight from the box without further adjustments. Alternatively, create your own control strategy with free DSELite software.

Standards

The DC590+ meets the following standards when installed in accordance with the relevant product manual

- **CE marked to EN50178 (Safety, Low Voltage Directive)**
- **EN61800-3 (EMC Directive) with integral filters (External supply capacitors are required up to 110A for compliance.)**
- **UL/cUL listed up to 500HP**



DC Drives - DC590+ Integrator Series

Features and Benefits

Easy to use operator controls

- Detailed diagnostics
- Multi-language display

Advanced autotuning

Standard open fieldbuses



Configurable input-output terminal blocks

- 5 analog inputs
- 3 analog outputs
- 9 digital inputs
- 3 digital outputs



Macro function blocks

- Open-loop winder control
- Winder control - loadcell/dancer
- Section control
- Maths functions
- Embedded controller functions

Worldwide product support

The DC590+ DC Drive is available with full application and service support worldwide. Wherever you are, you can be confident of full back up and support.



Rapid Commissioning, optimal control performance and easy maintenance

With its self-tuning algorithm, the DC590+ can be configured and commissioned within minutes, without turning the motor and without the need for high levels of engineering know how. The operator interface allows easy monitoring of machine operation and simplifies maintenance.

Easy integration into existing control networks

The DC590+ has a wide choice of common industry fieldbus communication options allowing seamless integration into existing factory control networks

Interfacing with existing external control equipment (Dancer, gauge, etc...)

A number of input / output options gives the DC590+ the flexibility needed for integration into any variable speed system. Combined with its embedded automation functions, its input-output configurations can in many instances eliminate the need for an external PLC.

Years of applications expertise at your service

The DC590+ macro function blocks are the result of years of experience gained by Parker of installing drives in variable speed and sectional drive systems. This unique application experience is included in the drive in the form of dedicated function blocks at no extra cost, thereby reducing the design costs of your machinery.



DC Drives - DC590+ Integrator Series

DRV Version -1A - 1950A

The DRV is a ready to install version of the DC590+ DC Drive.

The DC590+ is available in either module, or alternatively "DRV" format up to 1200 HP. The DRV includes all the peripheral power components associated with a DC drive system integrally fitted within the footprint of the drive. DRV options include the following integrally mounted within the drive:

- AC line or DC armature contactor
- AC line fuses
- DC fuse (On regenerative version)
- Control/field fuses
- Provision for optional motor blower starter
- Provision for optional auxiliary control transformer

All of these options can be supplied pre-wired within the drive.

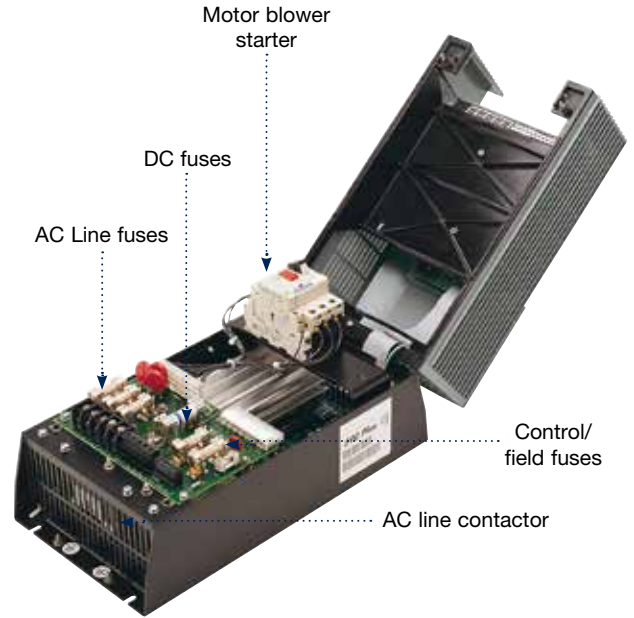

Advantages

- Simplified panel design
- Reduced component mounting and wiring
- Reduced design time
- Reduction of purchasing costs of individual components
- Less complexity



Traditional DC drive section



DC590+ DRV equivalent illustrating panel space saving

DC Drives - DC590+ Integrator Series

Technical Specifications

Specifications	
Power configuration	955+8Rxxx - 4 quadrant regenerative; 2 fully controlled 3 phase SCR bridges, DRV style
	955+8Nxxx - 2 quadrant; 1 fully controlled 3 phase SCR bridge, DRV style
	DC590+ - 4 quadrant regenerative; 2 fully controlled 3 phase thyristor bridges, chassis style
	DC591+ - 2 quadrant; 1 fully controlled 3 phase thyristor bridge, chassis style
Armature current rating (Amps DC)	Frame 1 15, 35A
	Frame 2 55, 70, 90, 110, 125, 165A
	Frame 3 206, 246A
	Frame 4 360, 425, 490, 700, 815A
	Frame 6 1200, 1600, 1950A
Overload	200% for 10 seconds
	150% for 30 seconds
	Higher ratings with reduced overload are available
Supply voltage (VAC) 50/60Hz	120-220V (±10%) All sizes
	220-500V (±10%) All sizes
	500-600V (±10%) Frame 4, 6
	600-690V (±10%) Frame 6
Field current max	Frame 1 4A
	Frame 2, 3 10A
	Frame 4 30A
	Frame 6 60A
Field voltage max	$V_{field} = V_{ac} \times 0.9$
Operating Environment	
Operating temperature	Frame 1, 2 0-45°C (32-113°F)
	Frame 3 - 6 0-40°C (32-104°F)
	Derate by 1%/°C up to 55°C (131°F)
Altitude	Up to 1640 ft (500m) above sea level Derate by 1%/200m above 500m to 5000m max



Standard 6901 MMI/Programming Keypad is provided with every DC590+ drive. It is easy to use, and may be remotely mounted.



Find out more...visit our DC Drives product page at www.parker.com/ssdusa/dc590plus

DC Drives - DC590+ Integrator Series

Technical Specifications

Protection	
	High Energy MOV's Heatsink Overtemperature Instantaneous Overcurrent SCR (thyristor) Trigger Failure Inverse Time Overcurrent Interline Snubber Network Field Failure Zero Speed Detection Speed Feedback Failure Stall Protection Motor Overtemperature
Inputs/Outputs	
Analog inputs	(5 Total - 12 bit plus sign) 1 - Speed demand setpoint (-10/0/+10V) 4 - Configurable
Analog outputs	(3 Total - 11 bit plus sign) 1 - Armature current output (-10/0/+10V or 0-10V) 2 - Configurable
Digital inputs	(9 Total - 24V, max 15mA) 1 - Program stop 1 - Coast stop 1 - External stop 1 - Start/Run 5 - Configurable
Thermistor Input	1 - Isolated
Digital outputs	(3 Total - 24V (max 30V) 100mA) 3 - Configurable
Reference Supplies	1 - +10V dc 1 - -10V dc 1 - +24V dc

Dimensions

Type	Frame	Dimensions (in/mm)		
		H	W	D
DRV	1	14.8/375	7.9/200	8.7/220
	2	21.5/546	7.9/200	11.5/292
	3	28.9/735	17.0/432	8.4/213
	4	54.0/1372	18.0/457	14.9/378
	6	38.0/966	56.0/1422	17.5/444
	Chassis	3	19.1/485	11.8/300
4		27.6/700	10.0/253	14.1/358
6		28.1/715	27.0/686	17.3/440

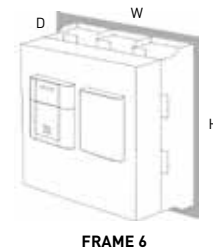
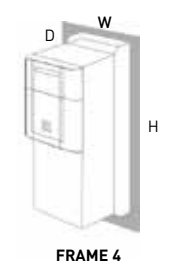
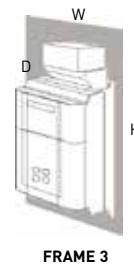
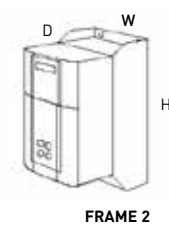

Gray panels represent footprint of DRV units for frames 3, 4, and 6.

Frame 1-4 have integral cooling fan assemblies where required. Optional ducting kit for cubicle roof external ventilation available for frame 4.

Note: Dimension table includes only the 230/460 volt ratings. Drives for a wide range of input voltages are available. For product codes, current ratings, and dimensional data on 110-220 volt, 575 volt, and 690 volt units, please consult factory. Drives of higher power ratings can also be provided upon request.

DC Drives - DC590+ Integrator Series

Overview of Frames 1,2 and 3 (Chassis)

1	Main drive assembly
2	Terminal cover
3	Terminal cover retaining screws
4	Blank cover
5	6901 keypad
6	COMMS technology box (optional)
7	Speed feedback technology card (optional)
8	Gland plate
9	Power terminal shield
10	Power terminals
11	Control terminals
12	Grounding points
13	Keypad port
14	RS232 programming port
15	Auxiliary power, external contactor and isolated thermistor terminals

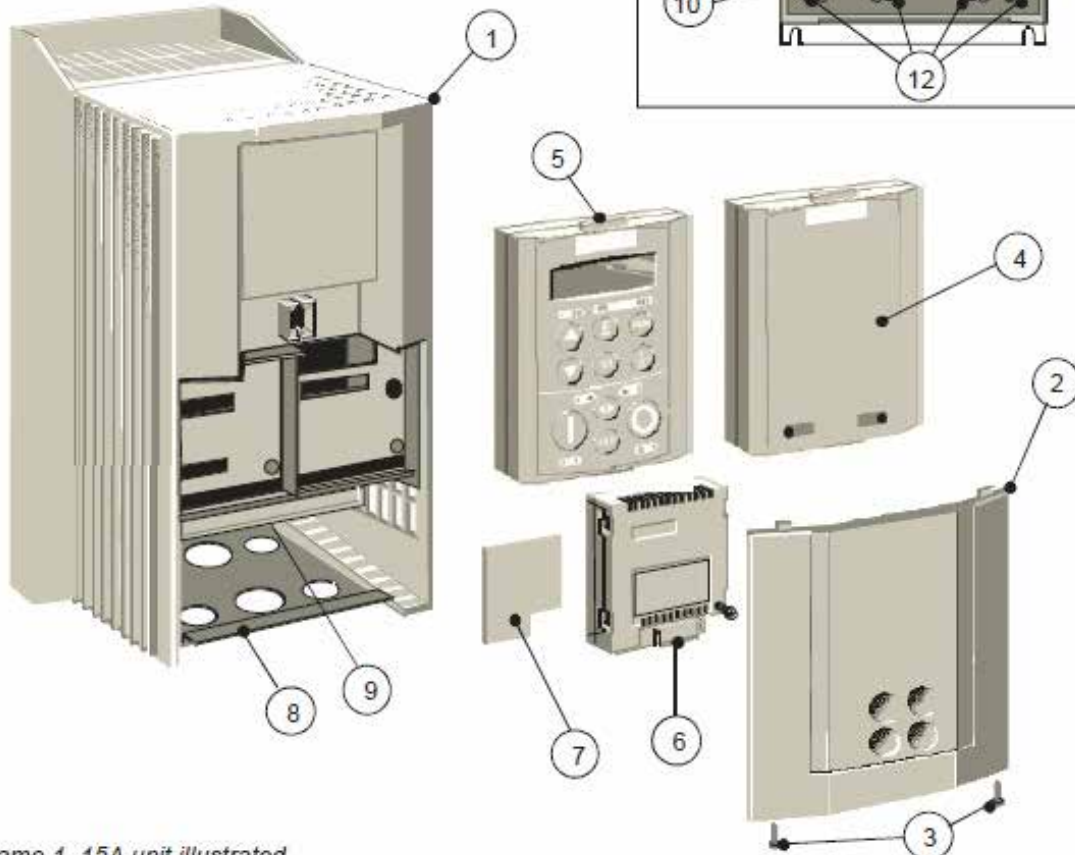
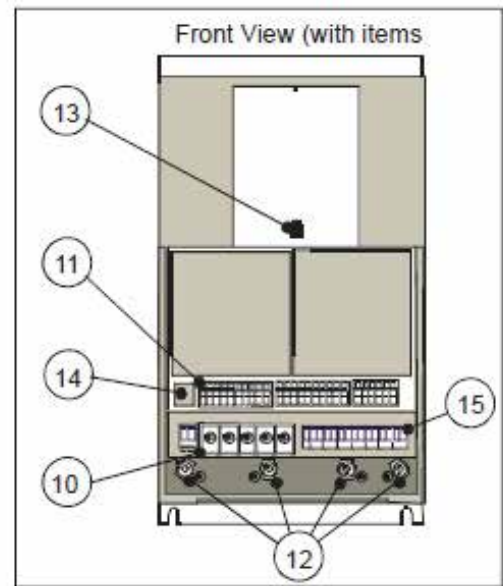

Frame 1, 15A unit illustrated

DC Drives - DC590+ Integrator Series

Overview of Frame 3/4 (Chassis)

1	Main drive assembly
2	Door assembly
3	Field wiring terminals
4	Busbars - main power input
5	Busbars - main power output
6	IP20 Top cover
7	IP20 Fan housing (where fitted)

1	Main drive assembly
2	Standard door assembly
3	Motor field terminals
4	Busbars - main power input
5	Busbars - main power output
6	Auxiliary supply, contactor and motor thermistor terminals
7	Frame 4 external vent (where fitted)
8	Contactor control select
9	Frame 5 External vent (where fitted)
10	Terminal cover (frame 5)

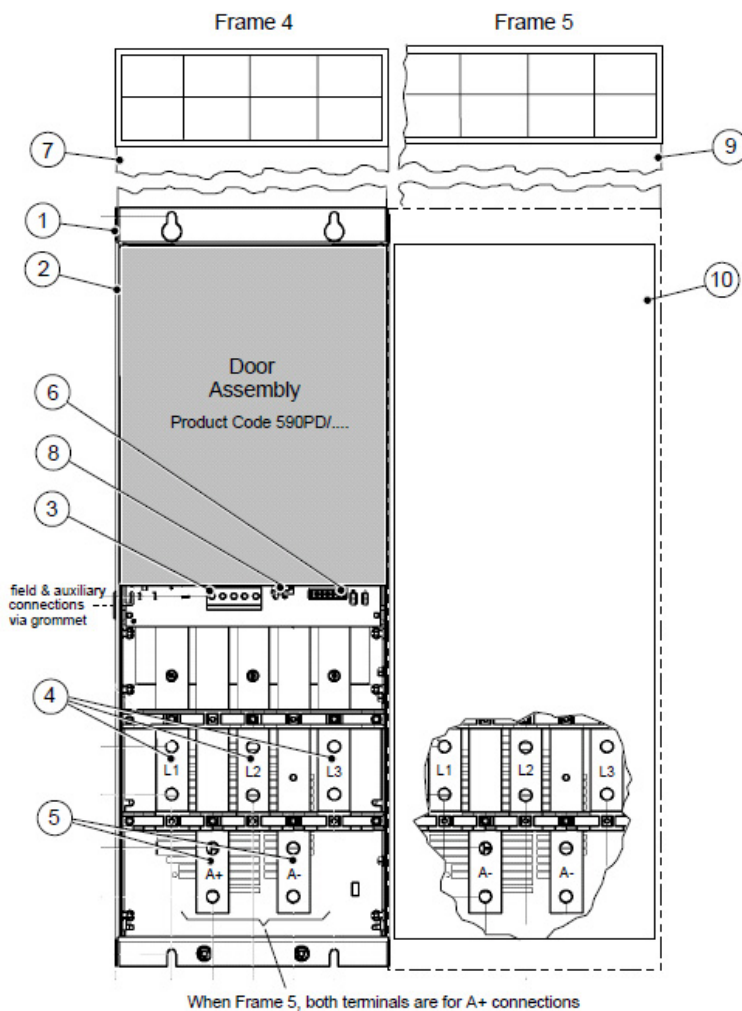
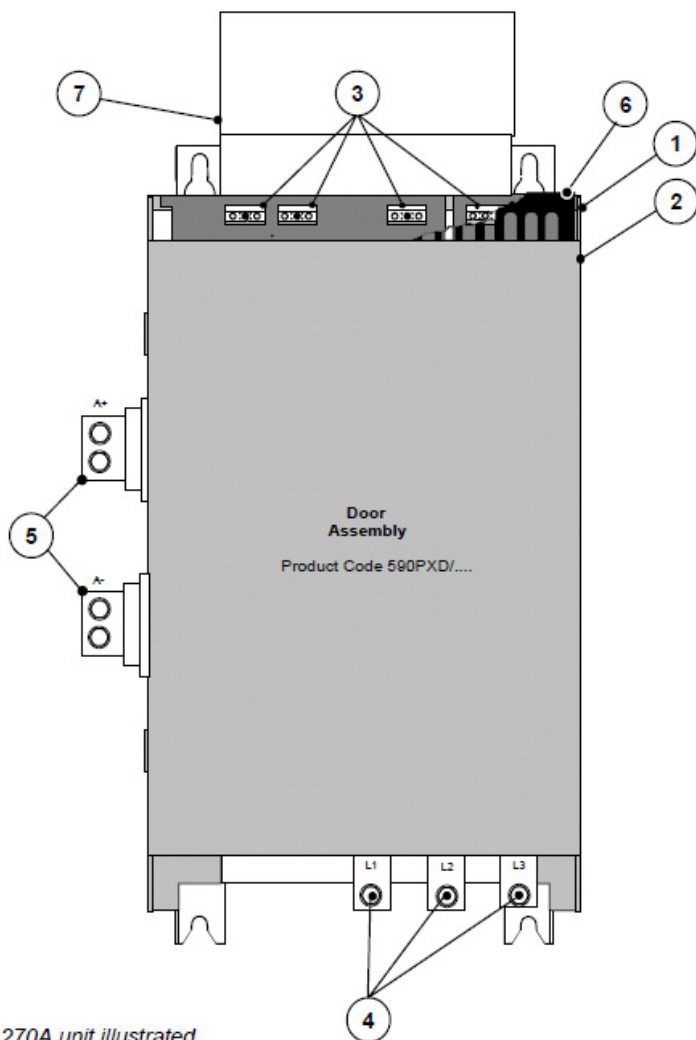

DC Drives - DC590+ Integrator Series

Overview of Frame 6 (Chassis)

- | | |
|---|-------------------------------|
| 1 | Phase assemblies - L1, L2, L3 |
| 2 | Fishplate |
| 3 | Control panel assembly |
| 4 | Front cover |
| 5 | Standard door assembly |
| 6 | Field controller |
| 7 | Busbars - main power input |
| 8 | Busbars - main power output |

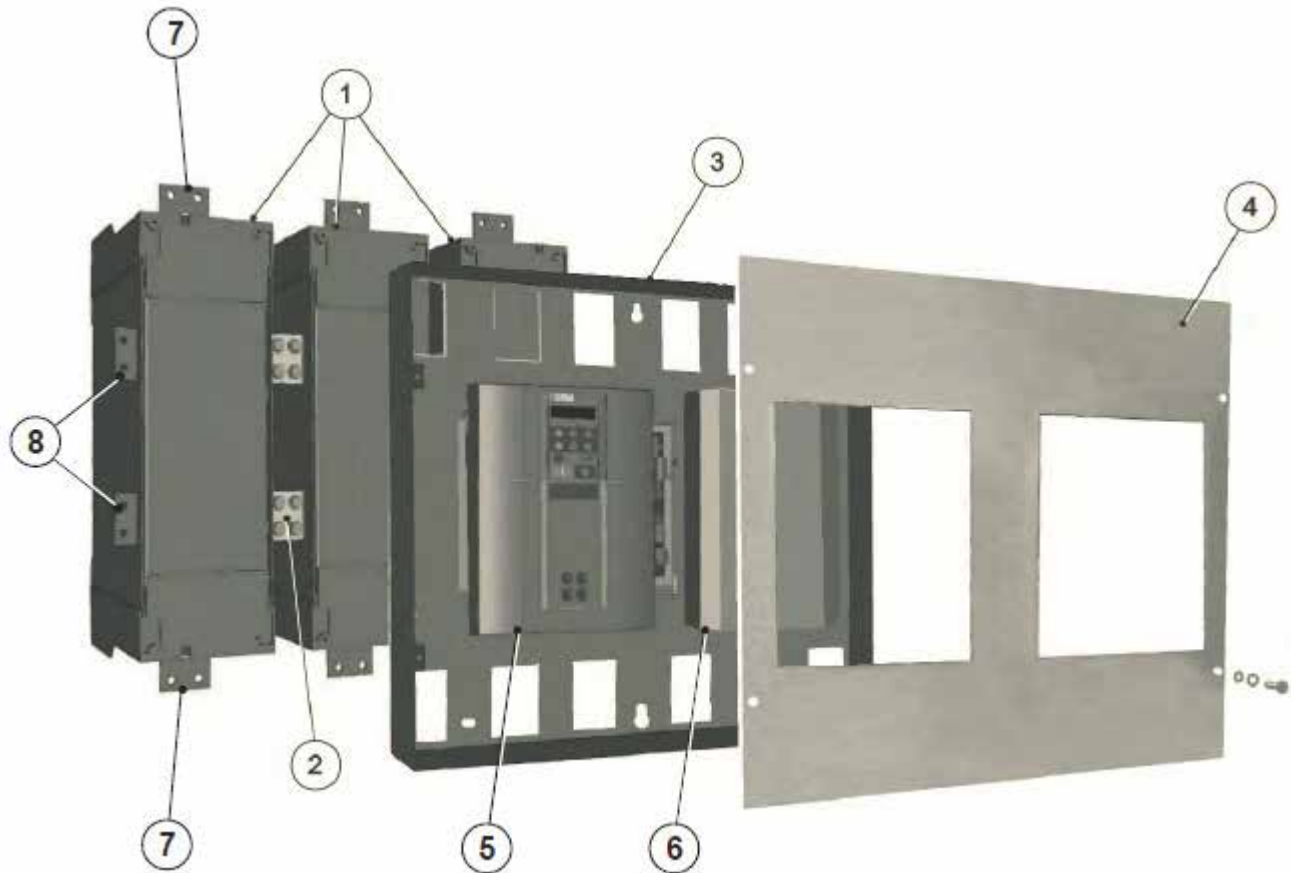

DC Drives - DC590+ Integrator Series

Electrical Characteristics

Type	Part Number		HP Rating	Max Amps	Frame
	Non-Regenerative	Regenerative	(230V/460V)		
DRV	955+8N0007	955+8R0007	3/7.5	15	1
	955+8N0020	955+8R0020	10/20	35	1
	955+8N0030	955+8R0030	15/30	55	2
	955+8N0040	955+8R0040	20/40	70	2
	955+8N0050	955+8R0050	25/50	90	2
	955+8N0060	955+8R0060	30/60	110	2
	955+8N0075	955+8R0075	40/75	125	2
	955+8N0100	955+8R0100	50/100	165	2
	955+8N0125-A3	955+8R0125-A3	60/125	206	3
	955+8N0125	955+8R0125	60/125	206	3
	955+8N0150-A3	955+8R0150-A3	75/150	246	3
	955+8N0150	955+8R0150	75/150	246	3
	955+8N0200-A4	955+8R0200-A4	100/200	360	4
	955+8N0200-D4	955+8R0200-D4	100/200	360	4
	955+8N0250-A4	955+8R0250-A4	125/250	425	4
	955+8N0250-D4	955+8R0250-D4	125/250	425	4
	955+8N0300-A4	955+8R0300-A4	150/300	490	4
	955+8N0300-D4	955+8R0300-D4	150/300	490	4
	955+8N0400-A4	955+8R0400-A4	200/400	700	4
	955+8N0400-D4	955+8R0400-D4	200/400	700	4
	955+8N0500-A4	955+8R0500-A4	250/500	815	4
	955+8N0500-D4	955+8R0500-D4	250/500	815	4
	955+8N0700-D6	955+8R0700-D6	700	1200	6
	955+8N1000-D6	955+8R1000-D6	1000	1600	6
	955+8N1200-D6	955+8R1200-D6	1200	1950	6
Chassis	591+0243/500	590+0243/500	75/150	243	3
	591+0380/500	590+0380/500	100/200	380	4
	591+0500/500	590+0500/500	150/300	500	4
	591+0725/500	590+0725/500	200/400	725	4
	591+0830/500	590+0830/500	250/500	830	4
	591+1250/500	590+1250/500	750	1250	6
	591+1600/500	590+1600/500	1000	1600	6
	591+1950/500	590+1950/500	1200	1950	6

Type	Non-Regenerative	Regenerative	AC Line Voltage	HP	Max Amps	Frame
DRV	955+CN0500-A4	955+CR0500-A4	575	500	700	4
	955+CN0500-D4	955+CR0500-D4	575	500	700	4
	955+CN0600-A4	955+CR0600-A4	575	600	815	4
	955+CN0600-D4	955+CR0600-D4	575	600	815	4
	955+CN0900-D6	955+CR0900-D6	575	900	1200	6
	955+CN1200-D6	955+CR1200-D6	575	1200	1600	6
	955+CN1350-D6	955+CR1350-D6	575	1350	1850	6
Chassis	591+1250/690	590+1250/690	690	1100	1250	6
	591+1600/690	590+1600/690	690	1400	1600	6
	591+1950/690	590+1950/690	690	1600	1850	6

Accessories and Options

Operator Interface and Feedback

Standard operator keypad

Part Number	Description
6901/00/G	Standard Keypad



Multilingual

English · French · German · Italian · Portuguese · Swedish · Polish

Quick setup menu

Intuitive menus allowing easy and quick setup of the drive

Auto-tuning

Automatic tuning of motor parameters ensures maximum dynamic motor performance

Diagnostics messages

Display input and output parameters as well as drive operating units

Drive configuration

Features

- **Local motor control: start, speed, direction, diagnostics**
- **Operator menus and parameter configuration**
- **Quick setup menu**
- **Password protection for parameter configuration**

Remote Mounting Kit - Optional

The optional keypad mounting kit includes bezel and lead

Part Number	Description
6052/00/G	Remote mounting kit

Feedback Cards

The feedback cards allows the use of various popular feedback devices on the motor to provide accurate measurement of motor speed. Encoder cards also provides power supply.

Part Number	Description
AH387775U005	Encoder Card +5VDC
AH387775U012	Encoder Card +12VDC
AH387775U015	Encoder Card +15VDC
AH387775U024	Encoder Card +24VDC

Specifications

Maximum input frequency	100KHz
Receiver current consumption	10mA per channel
Input format	2 channel differential and quadrature
Differential input voltage	Minimum 3.5V
Encoder power output	+5V to +24V available
Power supply rating	2W maximum
Power supply load	1.4 x output power
Terminal size	16 AWG maximum
Tightening torque	0.4Nm

Feedback Devices

Part Number	Description
AH500935U001	Analog Tach Generator
AH386025U001	Plastic fiberoptic Microtach
AH386025U002	Glass fiberoptic Microtach



Accessories and Options

Communication Cards

The communication “Tech Boxes” allow the DC590+ to be connected to the most common industry standard fieldbuses.

Devicenet Communications Interface

Part Number: 6055/DNET/00	
Supported Protocols	DeviceNet Drive Profile – Group 2 slave only
Station Address	DeviceNet Drive Profile – Group 2 slave only
Suitable for	DC590+ version 5.x+

RS485/Modbus Communications Interface

Part Number: 6055/EI00/00	
Supported Protocols	Modbus RTU, EI Bisynch ASCII
Cabling	RS485 2 or 4 wire
Communication Speed	300 to 115200 bits/s
Station Address	Selectable via software
Suitable for	DC590+ version 5.17+

LINKnet Communications Interface

Part Number: 6055/LNET/00	
Supported Protocols	Ethernet Modbus UDP/IP
Cabling	CAT-6 shielded
Communication Speed	100 Mbps
Suitable for	DC590+ firmware 8.10+

Features

- **Communication cards are provided separately for field installation**
- **Dimensions H x W D: 127mm x 76.2mm x 25.4mm**
- **LED indication of network and card status**

Ethernet Communications Interface

Part Number: 6055/ENET/00	
Supported Protocols	Modbus/TCP and Ethernet IP
Communication Speed	10/100M bits/s
Station Address	Selectable via switch or Internet Explorer
Suitable for	DC590+ version 7.1+

Profibus-DP Communications Interface

Part Number: 6055/PROF/00	
Supported Protocols	Profibus-DP
Communication Speed	Automatically detected
Station Address	Selectable via software
Suitable for	DC590+ version 5.x+



LINKnet is an Ethernet based version of the SSD LINK system. It is a peer-to-peer network designed to integrate AC and DC drives with remote I/O at high speed, with or without a supervisory PLC, allowing precise and repeatable control for complex machines and process lines. LINKnet nodes communicate using Modbus TCP over Ethernet.

LINKnet components are plugin compatible with many older Parker drives as well. An existing LINK system using AC690+ and/or DC590+ units can potentially be updated to LINKnet without requiring the replacement of functional drives. The system will connect to any Ethernet enabled PLC and with remote I/O. LINK2 touchscreens can be replaced by the Parker TS8000.

LINKnet tech boxes are connected by commercially available CAT-6 Ethernet cable, and require no external source of power when installed on a DC590+ drive. Parker has qualified third party remote fieldbus I/O modules for use in LINKnet systems. This provides users with an assortment of standard modules to choose from. Digital, analog and specialty modules may be combined, up to 64 per node, and will be recognized and supported by Parker DSE software.

Accessories and Options

Dynamic Braking and Contactors

Dynamic Braking Resistor Kits				
Drive HP	230 Volt		460 Volt	
	Part Number	Resistance (Ohms)	Part Number	Resistance (Ohms)
3	N/A	N/A	CZ353134	62
5	CZ353160	8.6	CZ353135	36
7.5	CZ353161	6.04	CZ353136	27
10	CZ353162	4.6	CZ353137	20
15	CZ353163	3	CZ353138	12
20	CZ353164	2	CZ353139	10
25	CZ353165	2	CZ353140	7
30	CZ353166	1.4	CZ353141	7
40	CZ353167	1	CZ353142	4.5
50	CZ353168	1	CZ353143	4.5
60	CZ353169	.742	CZ353144	4
75	CZ353170	.58	CZ353145	2.8
100	CZ353171	.452	CZ353146	2
125	CZ353172	.384	CZ353147	1.71
150	CZ353173	.325	CZ353148	1.28
200	CZ353174	.255	CZ353149	1.11
250	CZ353175	.196	CZ353150	.768
300	CZ353176	.176	CZ353151	.72
400	CZ353177	.137	CZ353152	.504
500	CZ353178	.1	CZ353153	.38
600	N/A	N/A	CZ353154	.38
700	N/A	N/A	CZ353155	.288
800	N/A	N/A	CZ353156	.23
900	N/A	N/A	CZ353157	.23
1000	N/A	N/A	CZ353158	.2

Armature Contactor Options			NOTES
Part Number	HP (230V)	HP (460V)	
3-pole DC loop contactor including D/B contact			For use with DC590+ frames 1 and 2, this option provides a 3 pole DC loop contactor with dynamic braking contact to isolate the motor armature from the drive. Dynamic braking requires a D/B Resistor Kit in addition.
955+ADC30	1-7.5	1-15	
955+ADC60	10-15	20-30	
955+ADC130	20-40	40-75	
955+ADC220	50	100	
D/B contact kit			All DC590+ DRV units (except 125 and 250 HP, which include a D/B contact on the DC contactor) require a separate dynamic braking contact kit if D/B is required. Through 100 HP, the kits use a 4-pole AC contactor pre-wired to the drive terminals. 300 HP and above, kits use a single pole DC contactor that requires 120 VAC control power to close. The D/B contact must be factory installed and requires a larger panel. D/B contact kits are designed to meet NEMA D/B requirements when used with D/B resistors above.
955+DBC35	1-10	1-20	
955+DBC70	15-20	30-40	
955+DBC110	25-30	50-60	
955+DBC162	40-50	75-100	
955+DBC2400*	150-700	300-1500	
955+DBC3000*	800-1000	1750-2000	



Accessories and Options

Filters, Control Transformer, BMS

EMC Filters

A range of pre-selected EMC (Electromagnetic Compatibility)/RFI (Radio Frequency Interference) Filters are available, suitable for all drives. These filters are a cost effective and easily implemented solution for the abatement of EMC in order to meet certain directives. Installation of the drive must be in accordance with the installation guidelines in the product manual.

Part Number	Rating	Type	Description
CO467844U015	15A	External	EMC Filter for DC590+ Drive
CO467844U040	35, 40A	External	EMC Filter for DC590+ Drive
CO467844U070	70A	External	EMC Filter for DC590+ Drive
CO467844U110	110A	External	EMC Filter for DC590+ Drive
CO467844U165	165A	External	EMC Filter for DC590+ Drive
CO467844U180	180A	External	EMC Filter for DC590+ Drive
CO467844U340	270A	External	EMC Filter for DC590+ Drive
CO467844U340 (2 req'd)	360A, 500A	External	EMC Filter for DC590+ Drive
CO467844U340 (3 req'd)	720A, 830A	External	EMC Filter for DC590+ Drive
LA048357	N/A	External	Line filter for DC590+ Drive, 460V
LA353827	N/A	External	Fuse kit for LA048357 line filter

Control Transformer

Operates with 208 through 500 VAC input. Mounts inside Frame 1 and 2 DRV. Not required on DRV over 100 HP/460V.

Control Transformer

Add -CX Suffix to Part Number

Factory installed only

For Frame 1 and 2 DRV

Blower Motor Starters

The blower motor starter option uses a manual motor circuit controller to provide motor overload and branch protection for a single or three phase AC blower motor. Blower motor starters are UL listed and CSA certified. They include Start/Stop-Reset switching with trip indication. One normally open auxiliary contact is included, wired to terminals.

Blower Motor Starters		
Blower Current Range	Frame 1 and 2 DRV	Frame 3 and higher DRV
0.16-0.25A	955+BMS025	955+BMS250
0.25-0.4A	955+BMS040	955+BMS40
0.4-0.63A	955+BMS063	955+BMS630
0.63-1.0A	955+BMS100	955+BMS11
1.0-1.6A	955+BMS160	955+BMS161
1.6-2.5A	955+BMS250	955+BMS251
2.5-4.0A	955+BMS400	955+BMS41
4.0-6.3A	955+BMS630	955+BMS631

Software Tools

Drive System Explorer (DSE)

DSE is the programming, monitoring and diagnostic software platform for the DC590+ drive. Thanks to the on-line help, users can achieve the optimum drive configuration without the need to navigate through complicated parameter menus. Advanced programming is carried out through a set of pre-engineered templates in order to create the required configuration. It is possible to monitor every parameter of the drive either as a digital value or as a function in the “chart recorder” during normal operation.

While the drive is in running mode the oscilloscope function allows “on-line” monitoring of selected parameters and the recording of trends. Using straightforward block programming, DSE allows the user to create, parameterize and configure user defined applications thanks to function blocks dedicated to speed control, inputs, outputs, ramps, winder functions, PID, diameter calculator, and more. Groups of function blocks can be combined into macros for more complex programs.

There are three levels of DSE software available.

- DSE Lite is provided as a free download, and is a fully functional package for drive programming, configuration, status monitoring, and diagnosis.
- DSE Development software adds the capability to create and edit projects using AC890 with Firewire communications.
- DSE Runtime allows the user to edit projects using AC890 with Firewire communications, but not create new ones.

For users of DSD software who wish to migrate to the DSE platform, we offer upgrade packages for both development and runtime versions of that product.

System Requirements

- Windows Vista® or Windows® XP, Home or Professional Edition operating system
- 100Mb of free hard disk space
- Serial port for connecting to DC590+ drive.

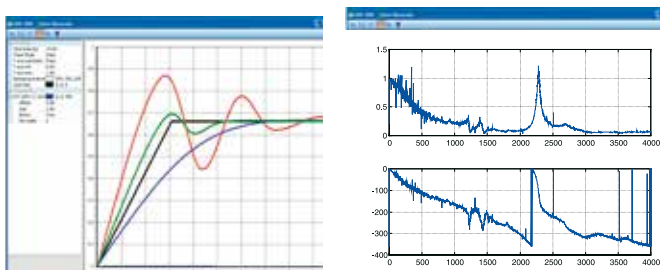

Real-time data acquisition and oscilloscope functions

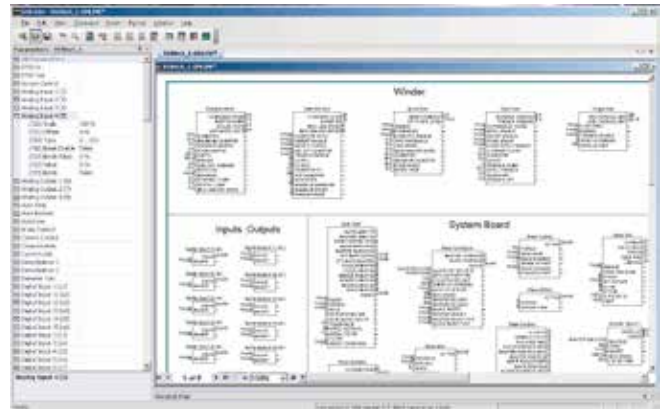

Function block configuration

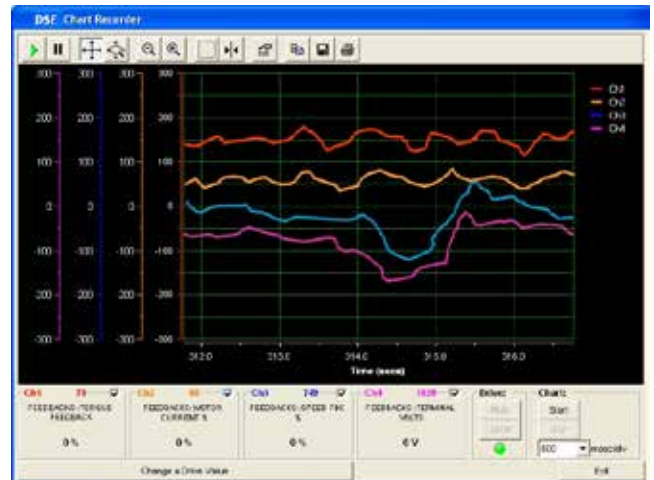

Chart recorder function

Part Number	Description
DSE-Lite	DSE Lite software (single axis) + USB cable*
8906-DSEDEV-00	DSE Development software + USB cable
8906-DSEDEV-00	DSE Runtime/Maintenance + USB cable
8906-DSEDEVUPG-00	DSD Development to DSE Development Upgrade + USB cable
8906-DSEDEVUPG-00	DSD Runtime to DSE Runtime Upgrade + USB cable

* DSE Lite may also be downloaded free of charge

Parker Engineered Solutions

Systems Build Capabilities

For customers preferring the convenience of more support in the design and implementation of their control systems, Parker and our network of integrators offer a complete in-house design and build service, enabling you to focus on your core competencies.

Based on the fundamental principles of application expertise, quality, reliability and safety, Parker's systems team is able to undertake all aspects of an electrical control system project, from pre-design specification to on-site commissioning, operator training, and preventative maintenance services.

By allowing Parker or one of our qualified integrators to undertake the design, build, programming and

commissioning of your motor control system, you can be assured that every aspect of the design, from environmental considerations through component selection to mounting of products has been carefully considered and allowed for.

Fully documenting a complete control system can be a daunting task for many equipment manufacturers, again Parker is on hand to help by providing complete electrical schematic and single line drawings as well as installation, maintenance and operating instructions.

As an accredited systems builder, Parker is also able to undertake the certification process required to enable systems to be put into service in any number of industrial markets.



Total Project Support

From concept to installation and beyond, Parker and our integrator network have a full range of complimentary capabilities to provide as much or as little support to your own team's expertise as you need. With a team of highly qualified and experienced design, build and service engineers, we take the risk out of any capital project by ensuring that all stages of the project are managed and executed precisely to your requirements.

Holding certification to the latest quality standards (ISO 9001 - 2008) means that as a customer, you can be assured of reliable, repeatable quality of design, build and documentation.

Integrators

Parker is backed by an extensive array of systems integrators with a plethora of controls experience. Each of our integrators has their own knowledge base in specific fields which allows us to provide support to a broad spectrum of markets. Our integrators offer a means for you to work with local engineering, service and support companies who pride themselves on catering to your facilities needs by improving system processes, eliminating downtime or simply helping you bring new products to market.



DC590+ External Stack Controller

DC598+, DC599+ Series

The unique, economical solution for retrofit applications

When upgrading machines equipped with older high power DC drives, the most cost-effective and quickest way is often to reuse the existing SCR power stack, which in most cases will be in perfect working order.

To preserve your investment, Parker has developed a DC598+/DC599+ power stack controller offer specially aimed at retrofit applications and based on the DC590+ controller.

Available in 2 versions, the DC599+ two quadrant non-regenerative and DC598+ four quadrant full-regenerative versions, can be used to drive the power stacks of existing DC drives manufactured by Parker or other manufacturers, delivering the benefits of the recent technological innovations of the DC590+ Series 2 drive.

The DC598+ and DC599+ offer the ability to upgrade your equipment quickly and easily and integrates with your existing control equipment or SCADA package.

The DC598+ and DC599+ retrofit solutions are recommended for currents above 800A.

Benefits

Reuse existing DC power stacks

Connectivity over standard common fieldbuses (Including Profibus, Ethernet, Devicenet, CANopen)

Easy to use operator interface

Flexible common Integrator Series programming environment.

Suitable for currents up to 2700A



The DC598/9+ external stack controllers provide the following:

- Thyristor firing signals
- Thyristor firing pulse transformers
- AC current transformer feedback rectification and scaling
- Armature voltage feedback interface
- Coding and phase rotation interface
- Mains present monitoring
- Heatsink over-temperature input
- Field power modules and input/output terminals
- Field current monitoring and scaling
- All standard DC590+ I/O terminals

DC590+ External Stack Controller

DC598+, DC599+ Series

Technical Specifications

Supply Voltage	110-240Vac ±10% 3ph coding or 1ph power 220-500Vac ±10% 3ph coding or 1ph power 380-690Vac ±10% 3ph coding or 1ph power
Supply Frequency	50/60Hz ±10%
Output Field Current	60A DC naturally cooled - 120A DC force cooled (1 x Field Current DC value) Amps 1ph. AC Nominal 3ph AC
Field Output Voltage	(0.9 x 1ph Supply Voltage) V DC
Total Losses	(3 x idc out) Watts.
Auxiliary Supply	110-240Vac ±10% 1ph - Naturally cooled 110-120Vac ±10% 1ph - Force cooled 115V fan 220-240Vac ±10% 1ph - Force cooled 230V fan
Auxiliary Supply Current	SMPS Quiescent Current = 500mA 115Vac or 250mA 230Vac ie 50VA. Fan current - 270mA @ 115Vac or 135mA @ 230Vac
Auxiliary Supply Fuse	3 Amps
Operating Temp.	0 to +45°C
Storage Temp.	-25 to +55°C
Shipping Temp.	-25 to +70°C
Enclosure Rating	IP20
Altitude Rating	Maximum Altitude 500m De-rate the output at 1% per 200 meters
Humidity	Maximum 85% relative humidity at 45% non- condensing
Atmosphere	Non flammable, non-corrosive and dust free
Climatic	Class 3k3 as defined by EN60721-3-3 (1995)

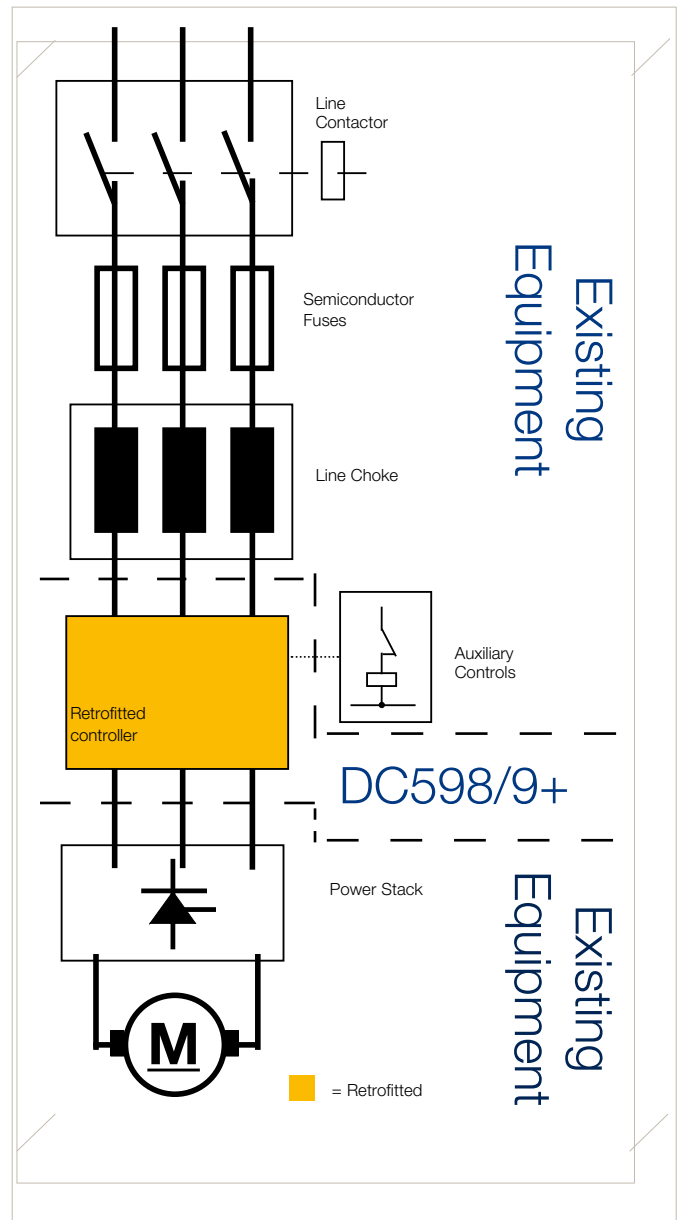

Standards

The DC598+ and DC599+ external stack controllers meet the requirements of EN50178 when mounted in an enclosure and also UL508C.

It is designed to meet Overvoltage category III and Pollution Degree 2

Application Profile

Ski Lift

Parker keeps skiers heading up the mountain at minimum cost to the operator



Summary

A ski resort with a DC drive-based lift system nearing the end of its usable life, needed to refit the lift with a new drive system to minimize downtime and maximize safety. A complete retrofit of the system, including all drive and motor sections, would be prohibitively expensive. Parker SSD Drives, while fully capable of providing the new, AC drive-based system, offered a DC drive retrofit as an economical alternative without compromising safety or reliability.

The DC590+ series of digital DC drives includes the same function-block based programming tools as its AC drive counterparts, providing the same level of system control without the costly replacement of the DC motor system. The TS8000 series touchscreen interface provided the operator with simple, intuitive visual controls, allowing the user to monitor critical parameters crucial to safety.

Benefits

- **Economic replacement of old, obsolete drives with latest control technology**
- **Visual monitoring of critical parameters ensure highest safety and reliability**
- **Simple, intuitive touchscreen control with plain language display reduces operator setup and training time**
- **Redundant safeties monitor all critical parameters**

Parker Drives Solution



DC590+ Integrator Series DC Drive

- Easily interfaces with existing application through function-block programming
- Retrofittable to existing motor applications
- Industry compatible I/O and communications
- Available to 2700A
- Proven technology with large installed base

Technical Support

- On-site commissioning and startup assistance
- Professional training courses available

Application Profile

Machine Upgrade - Winder/Unwinder



DC Drive retrofit improves system performance without a complete rebuild

Summary

A cardboard manufacturer planned to modernize an existing two-roll surface winding system, where the front and rear winding drums were driven by DC motors. Although the existing drives were obsolete and maintenance prone, the motors in use were in good working order. The company decided that the most economical solution was to retrofit the DC drives and logic, rather than replace motors and drives with an AC system. Parker DC590+ drives provided the user with an up to date system featuring improved system reliability via fiber-optic speed feedback, system monitoring with a graphic HMI terminal, an interface with an off-the-shelf PLC solution, and a complete system solution, including on-site commissioning and startup.

Benefits

- **Cost effective approach, using existing motors with new digital DC drives**
- **Complete system solution required minimum on-site wiring and labor**
- **Fiber-optic speed coordination provided EMI immunity**
- **Improved monitoring and maintenance with complete visualization solution, web enabled to allow remote access**

Parker Drives Solution

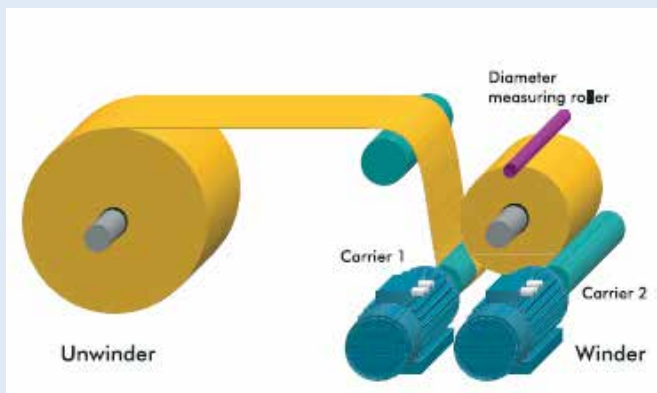

DC590+ Integrator Series DC Drive

- Microtach speed feedback, fiber-optic coordination
- Function block programming

TS8000 Operator Interface

- Color touchscreen terminal for operating and monitoring the machine
- Web-based alarm and I/O status thanks to built-in web server

System Solution

- Complete system solution including climate controlled cabinet
- Programming, commissioning, and startup of new system

Parker Worldwide

AE – UAE, Dubai

Tel: +971 4 8127100
parker.me@parker.com

AR – Argentina, Buenos Aires

Tel: +54 3327 44 4129

AT – Austria, Wiener Neustadt

Tel: +43 (0)2622 23501-0
parker.austria@parker.com

AT – Eastern Europe, Wiener Neustadt

Tel: +43 (0)2622 23501 900
parker.easteurope@parker.com

AU – Australia, Castle Hill

Tel: +61 (0)2-9634 7777

AZ – Azerbaijan, Baku

Tel: +994 50 2233 458
parker.azerbaijan@parker.com

BE/LU – Belgium, Nivelles

Tel: +32 (0)67 280 900
parker.belgium@parker.com

BR – Brazil, Cachoeirinha RS

Tel: +55 51 3470 9144

BY – Belarus, Minsk

Tel: +375 17 209 9399
parker.belarus@parker.com

CA – Canada, Milton, Ontario

Tel: +1 905 693 3000

CH – Switzerland, Etoy

Tel: +41 (0)21 821 87 00
parker.switzerland@parker.com

CL – Chile, Santiago

Tel: +56 2 623 1216

CN – China, Shanghai

Tel: +86 21 2899 5000

CZ – Czech Republic, Klecany

Tel: +420 284 083 111
parker.czechrepublic@parker.com

DE – Germany, Kaarst

Tel: +49 (0)2131 4016 0
parker.germany@parker.com

DK – Denmark, Ballerup

Tel: +45 43 56 04 00
parker.denmark@parker.com

ES – Spain, Madrid

Tel: +34 902 330 001
parker.spain@parker.com

FI – Finland, Vantaa

Tel: +358 (0)20 753 2500
parker.finland@parker.com

FR – France, Contamine s/Arve

Tel: +33 (0)4 50 25 80 25
parker.france@parker.com

GR – Greece, Athens

Tel: +30 210 933 6450
parker.greece@parker.com

HK – Hong Kong

Tel: +852 2428 8008

HU – Hungary, Budapest

Tel: +36 1 220 4155
parker.hungary@parker.com

IE – Ireland, Dublin

Tel: +353 (0)1 466 6370
parker.ireland@parker.com

IN – India, Mumbai

Tel: +91 22 6513 7081-85

IT – Italy, Corsico (MI)

Tel: +39 02 45 19 21
parker.italy@parker.com

JP – Japan, Tokyo

Tel: +81 (0)3 6408 3901

KR – South Korea, Seoul

Tel: +82 2 559 0400

KZ – Kazakhstan, Almaty

Tel: +7 7272 505 800
parker.easteurope@parker.com

LV – Latvia, Riga

Tel: +371 6 745 2601
parker.latvia@parker.com

MX – Mexico, Apodaca

Tel: +52 81 8156 6000

MY – Malaysia, Shah Alam

Tel: +60 3 7849 0800

NL – The Netherlands, Oldenzaal

Tel: +31 (0)541 585 000
parker.nl@parker.com

NO – Norway, Ski

Tel: +47 64 91 10 00
parker.norway@parker.com

NZ – New Zealand, Mt Wellington

Tel: +64 9 574 1744

PL – Poland, Warsaw

Tel: +48 (0)22 573 24 00
parker.poland@parker.com

PT – Portugal, Leca da Palmeira

Tel: +351 22 999 7360
parker.portugal@parker.com

RO – Romania, Bucharest

Tel: +40 21 252 1382
parker.romania@parker.com

RU – Russia, Moscow

Tel: +7 495 645-2156
parker.russia@parker.com

SE – Sweden, Spånga

Tel: +46 (0)8 59 79 50 00
parker.sweden@parker.com

SG – Singapore

Tel: +65 6887 6300

SK – Slovakia, Banská Bystrica

Tel: +421 484 162 252
parker.slovakia@parker.com

SL – Slovenia, Novo Mesto

Tel: +386 7 337 6650
parker.slovenia@parker.com

TH – Thailand, Bangkok

Tel: +662 717 8140

TR – Turkey, Istanbul

Tel: +90 216 4997081
parker.turkey@parker.com

TW – Taiwan, Taipei

Tel: +886 2 2298 8987

UA – Ukraine, Kiev

Tel: +380 44 494 2731
parker.ukraine@parker.com

UK – United Kingdom, Warwick

Tel: +44 (0)1926 317 878
parker.uk@parker.com

US – USA, Cleveland

Tel: +1 216 896 3000

VE – Venezuela, Caracas

Tel: +58 212 238 5422

ZA – South Africa, Kempton Park

Tel: +27 (0)11 961 0700
parker.southafrica@parker.com

