



HTTL Speed Feedback Communications Option

Technical Manual

HA467152U001 Issue 7

Compatible with Version 1.x Software - 690+
Compatible with Version 5.x Software - 605C

© Copyright 2010 Parker Hannifin Ltd

All rights strictly reserved. No part of this document may be stored in a retrieval system, or transmitted in any form or by any means to persons not employed by a Parker Hannifin Ltd., Automation Group, SSD Drives Europe without written permission from Parker Hannifin Ltd., Automation Group, SSD Drives Europe. Although every effort has been taken to ensure the accuracy of this document it may be necessary, without notice, to make amendments or correct omissions. Parker Hannifin Ltd., Automation Group, SSD Drives Europe cannot accept responsibility for damage, injury, or expenses resulting there from.

WARRANTY

Parker Hannifin Ltd., Automation Group, SSD Drives Europe, warrants the goods against defects in design, materials and workmanship for the period of 24 months from the date of manufacture, or 12 months from the date of delivery (whichever is the longer period) on the terms detailed in Parker SSD Drives Standard Conditions of Sale IA500504.

Parker Hannifin Ltd., Automation Group, SSD Drives Europe reserves the right to change the content and product specification without notice.

FAILURE OR IMPROPER SELECTION OR IMPROPER USE OF THE PRODUCTS DESCRIBED HEREIN OR RELATED ITEMS CAN CAUSE DEATH, PERSONAL INJURY AND PROPERTY DAMAGE.

This document and other information from Parker-Hannifin Corporation, its subsidiaries and authorized distributors provide product or system options for further investigation by users having technical expertise.

The user, through its own analysis and testing, is solely responsible for making the final selection of the system and components and assuring that all performance, endurance, maintenance, safety and warning requirements of the application are met. The user must analyze all aspects of the application, follow applicable industry standards, and follow the information concerning the product in the current product catalog and in any other materials provided from Parker or its subsidiaries or authorized distributors.

To the extent that Parker or its subsidiaries or authorized distributors provide component or system options based upon data or specifications provided by the user, the user is responsible for determining that such data and specifications are suitable and sufficient for all applications and reasonably foreseeable uses of the components or systems

Safety Information



Requirements

IMPORTANT: Please read this information BEFORE installing the equipment.

Intended Users

This manual is to be made available to all persons who are required to install, configure or service equipment described herein, or any other associated operation.

The information given is intended to highlight safety issues, EMC considerations, and to enable the user to obtain maximum benefit from the equipment.

Complete the following table for future reference detailing how the unit is to be installed and used.

INSTALLATION DETAILS	
Model Number <i>(see product label)</i>	
Where installed <i>(for your own information)</i>	
Unit used as a: <i>(refer to Certification for the Inverter)</i>	<input type="checkbox"/> Component <input type="checkbox"/> Relevant Apparatus
Unit fitted:	<input type="checkbox"/> Wall-mounted <input type="checkbox"/> Enclosure



Application Area

The equipment described is intended for industrial motor speed control utilising DC motors, AC induction or AC synchronous machines

Personnel

Installation, operation and maintenance of the equipment should be carried out by qualified personnel. A qualified person is someone who is technically competent and familiar with all safety information and established safety practices; with the installation process, operation and maintenance of this equipment; and with all the hazards involved.

Product Warnings

 Caution Risk of electric shock	 Caution Refer to documentation	 Earth/Ground Protective Conductor Terminal
--	--	--

Safety Information



Hazards

DANGER! - Ignoring the following may result in injury

1. This equipment can endanger life by exposure to rotating machinery and high voltages.
2. The equipment must be permanently earthed due to the high earth leakage current, and the drive motor must be connected to an appropriate safety earth.
3. Ensure all incoming supplies are isolated before working on the equipment. Be aware that there may be more than one supply connection to the drive.
4. There may still be dangerous voltages present at power terminals (motor output, supply input phases, DC bus and the brake, where fitted) when the motor is at standstill or is stopped.
5. For measurements use only a meter to IEC 61010 (CAT III or higher). Always begin using the highest range. CAT I and CAT II meters must not be used on this product.
6. Allow at least 5 minutes for the drive's capacitors to discharge to safe voltage levels (<50V). Use the specified meter capable of measuring up to 1000V dc & ac rms to confirm that less than 50V is present between all power terminals and earth.
7. Unless otherwise stated, this product must NOT be dismantled. In the event of a fault the drive must be returned. Refer to "Routine Maintenance and Repair".

WARNING! - Ignoring the following may result in injury or damage to equipment

SAFETY

Where there is conflict between EMC and Safety requirements, personnel safety shall always take precedence.

- Never perform high voltage resistance checks on the wiring without first disconnecting the drive from the circuit being tested.
- Whilst ensuring ventilation is sufficient, provide guarding and /or additional safety systems to prevent injury or damage to equipment.
- When replacing a drive in an application and before returning to use, it is essential that all user defined parameters for the product's operation are correctly installed.
- All control and signal terminals are SELV, i.e. protected by double insulation. Ensure all external wiring is rated for the highest system voltage.
- Thermal sensors contained within the motor must have at least basic insulation.
- All exposed metalwork in the Inverter is protected by basic insulation and bonded to a safety earth.
- RCDs are not recommended for use with this product but, where their use is mandatory, only Type B RCDs should be used.

EMC

- In a domestic environment this product may cause radio interference in which case supplementary mitigation measures may be required.
- This equipment contains electrostatic discharge (ESD) sensitive parts. Observe static control precautions when handling, installing and servicing this product.
- This is a product of the restricted sales distribution class according to IEC 61800-3. It is designated as "professional equipment" as defined in EN61000-3-2. Permission of the supply authority shall be obtained before connection to the low voltage supply.

CAUTION!

APPLICATION RISK

- The specifications, processes and circuitry described herein are for guidance only and may need to be adapted to the user's specific application. We can not guarantee the suitability of the equipment described in this Manual for individual applications.

RISK ASSESSMENT

Under fault conditions, power loss or unintended operating conditions, the drive may not operate as intended.

In particular:

- Stored energy might not discharge to safe levels as quickly as suggested, and can still be present even though the drive appears to be switched off
- The motor's direction of rotation might not be controlled
- The motor speed might not be controlled
- The motor might be energised

A drive is a component within a drive system that may influence its operation or effects under a fault condition.

Consideration must be given to:

- Stored energy
- Supply disconnects
- Sequencing logic
- Unintended operation

Contents

Contents

Page

HTTL SPEED FEEDBACK OPTION	1
Description	1
• <i>Features</i>	1
• <i>Used On</i>	1
• <i>Specifications</i>	1
Recommended Spare Parts	1
Installation	2
Wiring the System : 605C, 690+ Frames C-K	2
• <i>DIP Switch Settings</i>	3
• <i>Terminal Block (TB1) Connections</i>	3
• <i>Understanding the LED Indications</i>	4
Wiring the System : 690+ Frame B	4
• <i>DIP Switch Settings</i>	5
• <i>Terminal Block (TB1) Connections</i>	5
Initial Set-up	6
Configuring the 605C Inverter	6
Configuring the 690+ Inverter.....	8
Parker SSD Drives Approved Encoders	9

HTTL SPEED FEEDBACK OPTION

Description

The HTTL Speed Feedback Option allows incremental encoders to be connected directly to the motor controller to provide highly accurate speed feedback measurement.

Features

The option has the following features:

- Contains up to four optically isolated differential inputs on channels A, B, M and H
- Decoding logic to interface the encoder to the microprocessor
- Supplies variable voltage, isolated encoder power supply

Used On

The HTTL Speed Feedback Option is provided in two forms:

1. Technology Box -for use with the 605C Inverter and 690+ Frames C-K Inverter
2. Speed Feedback Board - for use with the 690+ Frame B

Specifications

	Technology Box	Speed Feedback Board
Maximum Pulse Rate	250kHz	250kHz
Receiver Current	≤10mA per channel	≤10mA per channel
Input Format	Two channels in quadrature, clock/dir or clock only	Two channels in quadrature, clock/dir or clock only
Phase Displacement	>1 μ s	>1 μ s
Input Voltage	10 - 30V differential recommended, or single-ended	10 - 30V differential recommended, or single-ended
Encoder Supply	Maximum load = 200mA or 2W, whichever is smaller. Voltage adjustable approximately 10-20V by firmware	Maximum load = 200mA or 2W, whichever is smaller. Voltage adjustable approximately 10-20V by firmware
Terminal Wire Size (maximum)	16 AWG	16 AWG
Terminal Tightening Torque	0.4Nm (3.5 pound-inches)	0.2Nm (1.75 pound-inches)

Recommended Spare Parts

We recommend that you keep one option as a spare to reduce down-time.

2

Installation

WARNING!

Disconnect all sources of power before attempting installation. Injury or death could result from unintended actuation of controlled equipment.

Caution

This option contains ESD (Electrostatic Discharge) sensitive parts. Observe static control precautions when handling, installing and servicing this option.

Wiring the System : 605C, 690+ Frames C-K

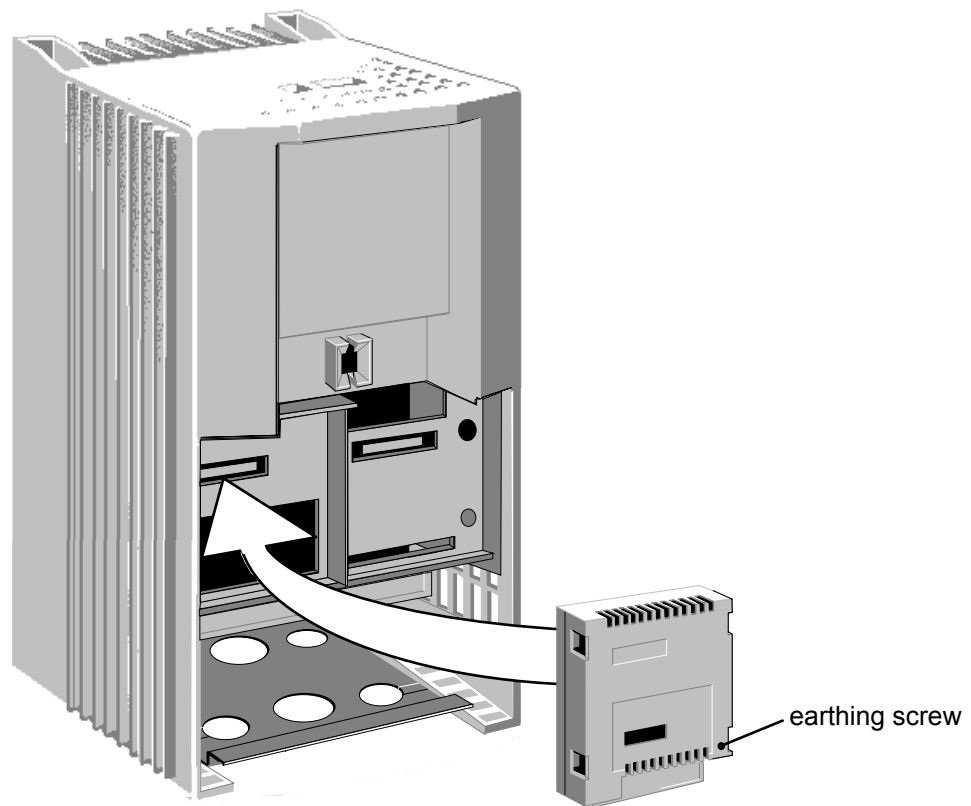

Figure 1 Installing the HTTL Speed Feedback Technology Box Option (605C illustrated)

1. Unpack and handle the Option using correct static safety procedures.
2. Remove the inverter terminal cover and securing screws.
3. Carefully plug the Option into the left-hand port (as illustrated above) ensuring correct alignment of the connector and tighten the earthing screw. You can operate the Inverter with the Speed Feedback and/or a Communications Technology Box, but you **cannot** use two options of the same kind.

DIP Switch Settings

The DIP switch can be seen through the casing of the HTTL Speed Feedback Technology Box.

The switch settings control the following inputs:

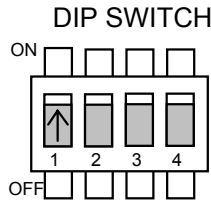

Input Threshold				
Switch Number	1	2	3	4
Input Controlled	H	A	B	M
3V±1	On	On	On	On
8V±1	Off	Off	Off	Off

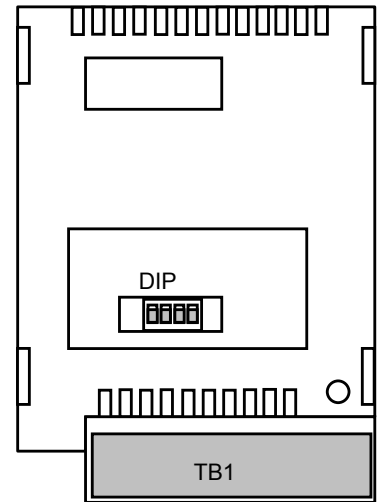

Usually the switches will be set to give a threshold of 3V when using a differential encoder, and to 8V when using a single-ended encoder. (Factory default is with switches 1 & 2 set in the ON position - 3V).

Terminal Block (TB1) Connections

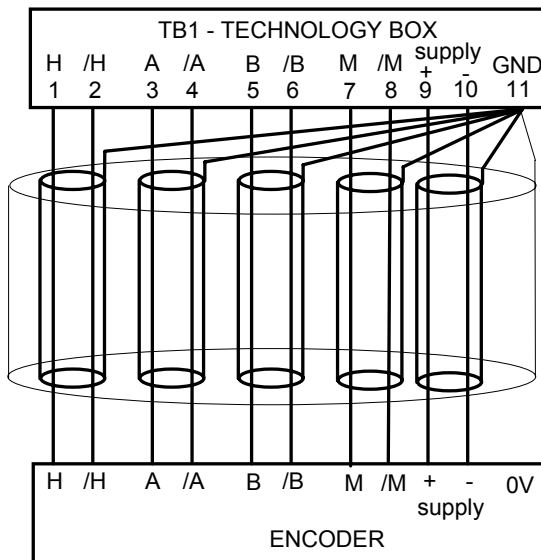

Figure 3 Differential Encoder Outputs

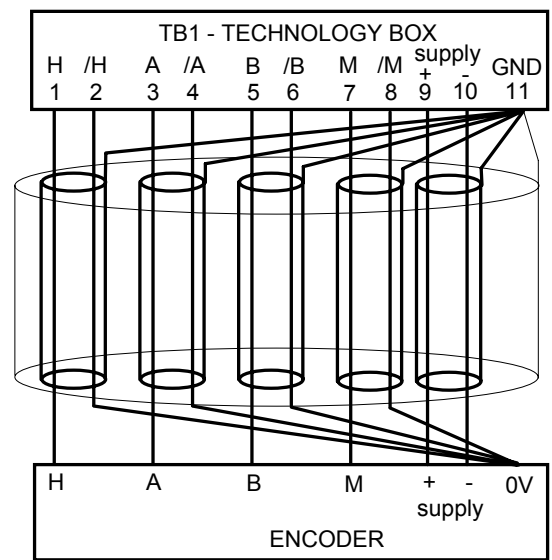

Figure 2 Single-Ended Encoder Outputs

For correct operation, A, /A, B and /B **must** be connected as shown. If any is left unconnected, the HTTL speed feedback technology box will not operate.

Note: The M and H inputs are not normally connected - these are for use with future versions of drive software.

M: For connection to the once-per-revolution marker output from the encoder to verify correct operation of the encoder.

H: For where the encoder has provision for a 'health' output.

Take special care wiring the encoders to the option due to the low level of the signals.

All wiring to the HTTL Speed Feedback Technology Box should be made in screened cable. Use cable with an overall screen and a screen over each individual pair. To ensure compliance with the EMC Directive the overall cable screen should be connected to the encoder body and to the terminal block, pin 11.

Recommended cable (pairs individually screened):

- Belden equivalent 8777
- Parker SSD Drives Part Number CM052666

Understanding the LED Indications

Module LED

In normal operation this LED will be ON. If it fails to come on within 10 seconds after power-up check that the Technology Box is correctly installed.

Encoder LED

This will indicate the status of the Health inputs, pins 1 and 2 on future versions of drive software. If the voltage across pins 1 and 2 exceeds the Minimum Differential Input Voltage set by the DIP switch, the Encoder LED will be ON (pin 1 is positive with respect to pin 2).

Wiring the System : 690+ Frame B

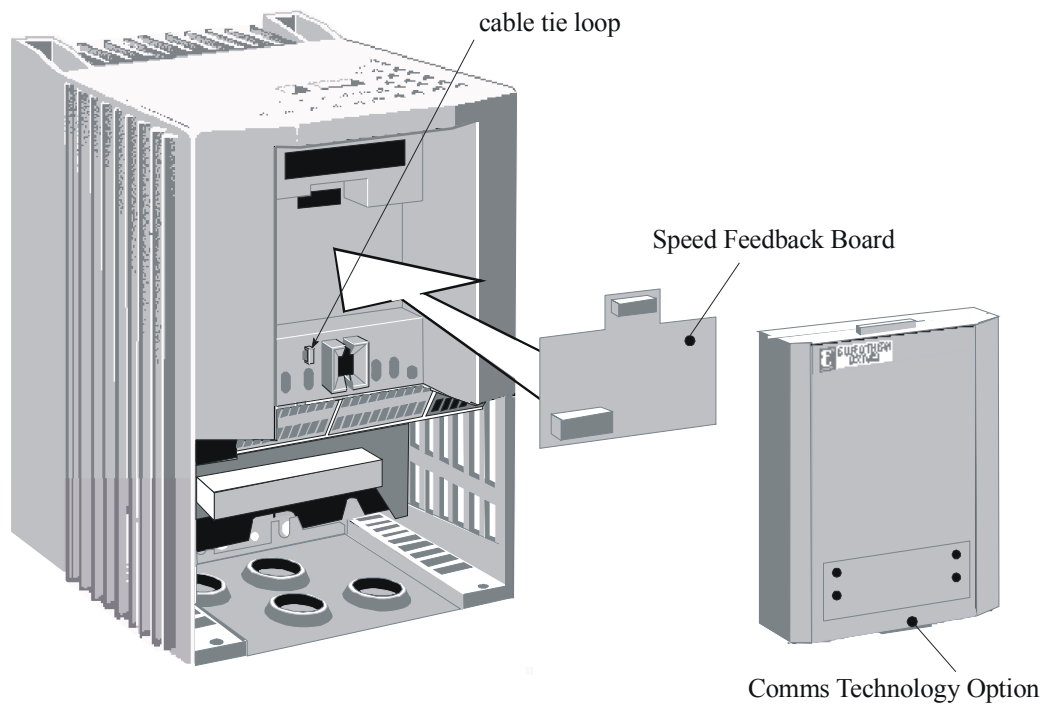

Figure 4 The HTTL Speed Feedback Board fitted to 690+ Frame B

The option is factory-fitted using correct static safety procedures. The cable tie loop is used to secure the connecting cable so that it doesn't obstruct the LED light pipes used by the Comms Technology Option.

DIP Switch Settings

The DIP switch settings control the following inputs:

Input Threshold		
Switch Number	1	2
Input Controlled	A	B
3V±1	On	On
8V±1	Off	Off

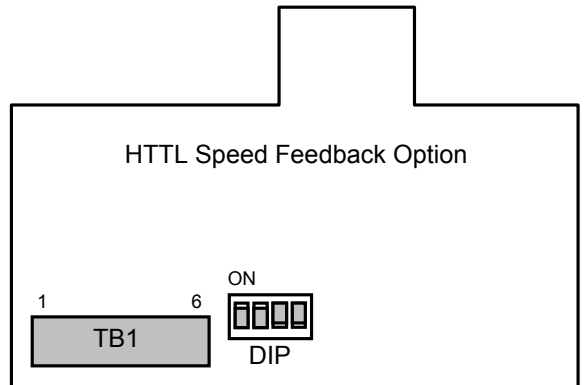

Usually the switches will be set to give a threshold of 3V when using a differential encoder (as shown), and to 8V when using a single-ended encoder. (Factory default is with switches 1 & 2 set in the ON position - 3V).

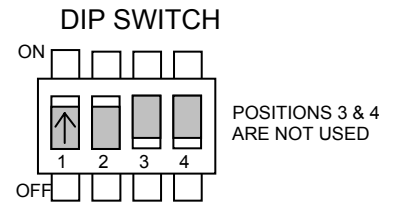

Terminal Block (TB1) Connections

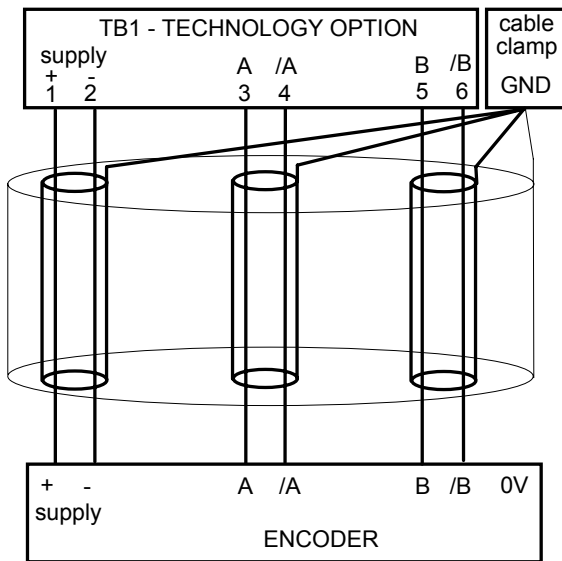

Figure 5 Differential Encoder Outputs

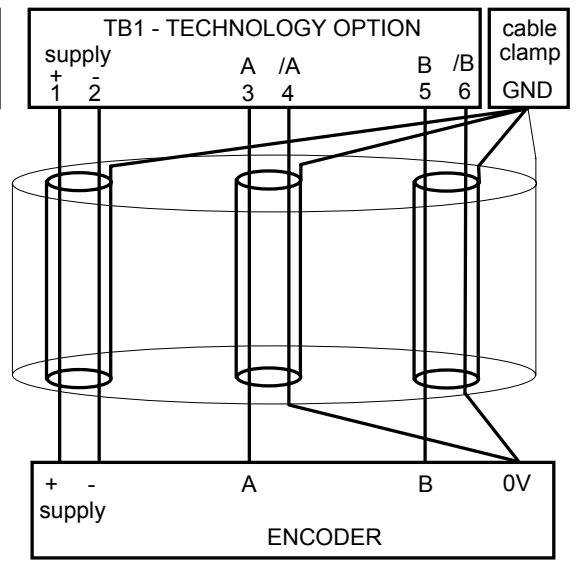

Figure 6 Single-Ended Encoder Outputs

Note: The GND connection shown above is the screen connection, some encoder manufacturers use a different terminology.

For correct operation, A, /A, B and /B **must** be connected as shown. If any is left unconnected, the HTTL speed feedback technology box will not operate.

Take special care wiring the encoders to the option due to the low level of the signals.

All wiring to the Speed Feedback option should be made in screened cable. Preferably, use cable with an overall screen and a screen over each individual pair. To ensure compliance with the EMC Directive the overall cable screen should be connected to the encoder body and to the cable clamp.

Recommended cable:

Belden equivalent 8164 - overall screen and pairs individually screened

Belden equivalent 8777 - pairs individually screened, ParkerSSD Drives Part No CM052666

Initial Set-up

Configuring the 605C Inverter

MMI Menu Map

- 1 SETUP PARAMETERS
- 2 FUNCTION BLOCKS
- 3 INPUTS & OUTPUTS
- 4 ENCODER
 - ENCODER MODE
 - ENCODER LINES
 - ENCODER INVERT
 - ENCODER RESET
 - ENCODER SUPPLY
 - ENCODER SPEED
 - ENCODER SPEED
 - ENCODER SPEED
 - ENCODER POSITION

Using the Operator Station (MMI) or other suitable PC programming tool, the ENCODER function block requires configuring before the HTTL option can be used.

DSE Lite is Parker SSD Drives' Windows-based block programming software.

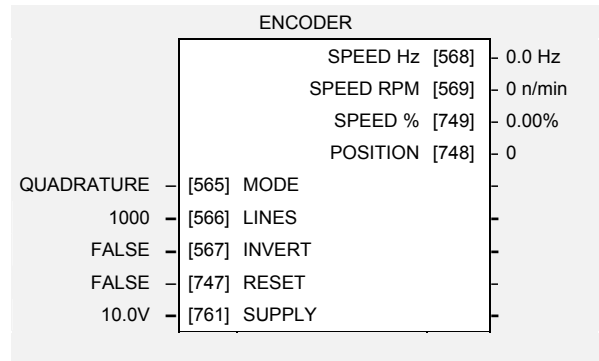

Parameter Descriptions

MODE

Range: Enumerated, see below

This must be set to QUADRATURE, CLOCK/DIR or CLOCK.

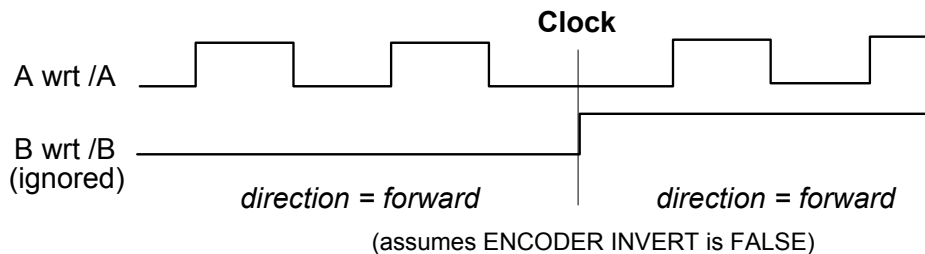
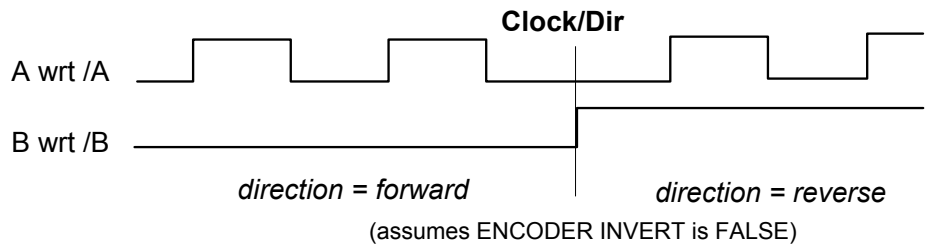
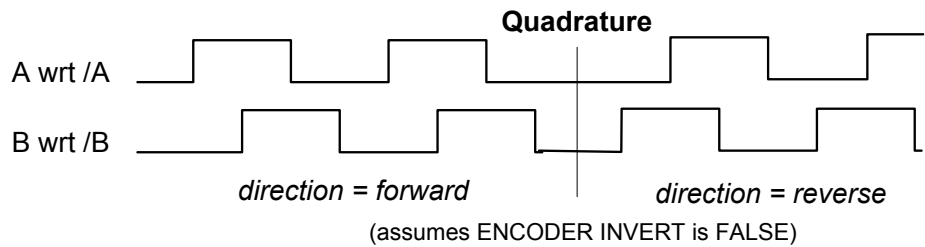

Enumerated Value : Encoder Mode

- 0 : QUADRATURE
- 1 : CLOCK/DIR
- 2 : CLOCK

LINES*Range: 1 to 10000*

The number of lines must be set to match the type of encoder being used. Incorrect setting of this parameter will result in an erroneous speed measurement.

INVERT*Range: FALSE / TRUE*

When TRUE, changes the sign of the measured speed and the direction of the position count.

RESET*Range: FALSE / TRUE*

When TRUE, the POSITION output is set (and held) at zero.

SUPPLY*Range: 10.0 to 20.0V*

Approximate encoder supply voltage.

SPEED Hz*Range: xxx.xHz*

Speed feedback in Hz.

SPEED RPM*Range: xxxxx n/min*

Speed feedback in RPM.

SPEED %*Range: xxx.xx%*

Speed feedback as a percentage of MAXIMUM SPEED.

POSITION*Range:*

(increments @ 4 x line rate, i.e. 1 revolution = 4000 for a 1000 line encoder)

Number of encoder "counts" from when RESET was set to FALSE. The value will increment or decrement depending on the direction the encoder is rotated. The value will "wrap around" between 32767 and -32768.

Configuring the 690+ Inverter

MMI Menu Map	
1	SETUP
2	MOTOR CONTROL
3	FEEDBACKS
	ENCODER SUPPLY
	ENCODER LINES
	ENCODER INVERT
	QUADRATIC TORQUE
	DC LINK VOLTS
	TERMINAL VOLTS
	SPEED FBK RPM
	SPEED FBK HZ
	SPEED FBK %
	ENCODER COUNT
	TORQUE FEEDBACK
	FIELD FEEDBACK
	MOTOR CURRENT %
	MOTOR CURRENT A

Using the Operator Station (MMI) or other suitable PC programming tool, this function block requires configuring before the HTTL option can be used.

DSE Lite is SSD Drives' Windows-based block programming software.

Ranges for some outputs are given as “—xx %”, for example, indicating an indeterminate integer for the value, to two decimal places.

Note that only parameters relevant to the Encoder are described below.

Parameter Descriptions

ENCODER SUPPLY

Range: 10.0 to 20.0V

Set this to the supply voltage required by the encoder.

ENCODER LINES

Range: 250 to 1000000

The number of lines must be set to match the type of encoder being used. Incorrect setting of this parameter will result in an erroneous speed measurement.

** Set to a value depending on the overall “power build “ of the Inverter.

ENCODER INVERT

Range: FALSE/TRUE

Used to match the encoder direction to the motor direction. When TRUE, it changes the sign of the measured speed and the direction of the position count.

It is especially necessary to set up this parameter when in CLOSED-LOOP VEC mode, as the encoder direction must be correct for this mode to operate.

SPEED FEEDBACK RPM

Range: —xx rpm

The mechanical speed of the motor shaft in revolutions per minute.

SPEED FEEDBACK HZ

Range: —xx Hz

This parameter changes according to the CONTROL MODE (MOTOR DATA function block):

- In CLOSED-LOOP VEC mode, or SENSORLESS VEC mode, the parameter shows the mechanical speed of the motor shaft in revolutions per second.
- In VOLTS / Hz mode, the parameter shows the drive output frequency.

SPEED FEEDBACK %

Range: —xx %

Shows the mechanical speed of the motor shaft as a percentage of the user maximum speed setting (MAX SPEED in the SETPOINT SCALE function block).

ENCODER COUNT

Range: —.

(increments/decrements @ 4 x line rate, i.e. 1 revolution = 4000 for a 1000 line encoder)

This is a 16-bit register which is incremented or decremented by the pulses from the encoder. It is useful to check that the encoder is operating, and to measure the encoder lines, if this is not known. Rotate the motor shaft through 1 revolution and note the difference between readings at the start and finish. The difference should be 4 times the encoder lines. For greater accuracy, rotate the shaft through several revolutions.

The direction of count is unaffected by ENCODER INVERT.

Feedbacks	
—	DC LINK VOLTS [75] 0 V
—	TERMINAL VOLTS [1020] 0 V
—	SPEED FEEDBACK [569] 0.00 rpm
—	SPEED FEEDBACK HZ [568] 0.00 Hz
—	SPEED FEEDBACK % [749] 0.00 %
—	ENCODER COUNT [1016] 0
—	TORQUE FBK [70] 0.00 %
—	FIELD FBK [73] 0.00 %
—	MOTOR CURRENT % [66] 0.00 %
—	MOTOR CURRENT [67] 0.0 A
10.0 V	[761] ENCODER SUPPLY
** 2048	[566] ENCODER LINES
FALSE	[567] ENCODER INVERT
FALSE	[50] QUADRATIC TORQUE

Parker SSD Drives Approved Encoders

Recommended Encoder (12mm bore)	Hengstler: Parker SSD Drives Part Number:	RI 58TD//2048ED.37IF DD464475U012
Alternative Encoders (20mm bore)	Hengstler: Parker SSD Drives Part Number:	RI 76TD/2048ED-4N20IF DD464475U020

Encoders are available from Hengstler in other accuracies such as 500 lines/rev or 2000 lines/rev to suit the application.

