



Level Master Control

For Valve Types P, H, M, V, and W

SPORLAN



ENGINEERING YOUR SUCCESS.

5 Benefits of the



1

Modulated Flow

The Level-Master Control provides a modulated flow and maintains practically a static liquid level in the low side.

2

No Moving Parts

The insert bulb controlling the liquid level has no moving parts. Control does not operate through use of a mechanical float device of any kind.

3

Simplified and Economical Installation

The insert bulb can be placed directly in the shell, accumulator or liquid leg for direct contact with refrigerant. Existing float control systems can be easily and economically converted.

4

Not Affected by Turbulence

When agitation occurs in the low side, the effect on the Level-Master is merely that of striking a mean level and holding that level constant.

5

Tight Closing is assured by the spring action in the thermostatic expansion valve during shut down periods when the heater element is off and liquid refrigerant is in contact with the bulb.

Level Master Control

The Sporlan Level-Master Control is a positive liquid level control device suitable for application to all flooded evaporators.

Application and Installation Description and Operation

The LMC is a standard thermostatic expansion valve equipped with a Level-Master Element. The combination provides a simple, economical and highly effective liquid level control. The bulb of the conventional thermostatic element has been modified to an insert type of bulb which incorporates a low wattage heater. **A 15 watt heater is supplied as standard. For applications below -60°F evaporating temperature specify a special 25 watt heater.**

The insert bulb is installed in the accumulator or surge drum at the point of the desired liquid level. As the level at the insert bulb drops, the electrically added heat increases the pressure within the thermostatic element and opens the valve. As the liquid level at the bulb rises, the electrical input is balanced by the heat transfer from the bulb to the liquid refrigerant and the LMC either modulates or eventually shuts off. The evaporator pressure and spring assist in providing a positive closure.

General

The Level-Master control can be applied on any system that has been specifically designed for flooded operation.

Sporlan is not responsible for system design and, therefore is not liable for any damage arising from faulty design or improper piping, or for misapplication of its products. Figures 2 through 6 are piping schematics only to illustrate possible methods of applying the LMC valves.

If these valves are applied in any manner other than as described in this bulletin, the Sporlan warranty is void. The system piping should be designed to protect the compressor at all times. This includes protection against overheating, slugging with liquid refrigerant, and trapping oil in various system locations. Sporlan recommends that recognized piping references, such as equipment manufacturers' literature and the ASHRAE Handbooks be consulted for assistance.

⚠ WARNING – USER RESPONSIBILITY

Failure or improper selection or improper use of the products described herein or related items can cause death, personal injury and property damage.

This document and other information from Parker Hannifin Corporation, its subsidiaries and authorized distributors provide product or system options for further investigation by users having technical expertise.

The user, through its own analysis and testing, is solely responsible for making the final selection of the system and components and assuring that all performance, endurance, maintenance, safety and warning requirements of the application are met. The user must analyze all aspects of the application, follow applicable industry standards, and follow the information concerning the product in the current product catalog and in any other materials provided from Parker or its subsidiaries or authorized distributors.

To the extent that Parker or its subsidiaries or authorized distributors provide component or system options based upon data or specifications provided by the user, the user is responsible for determining that such data and specifications are suitable and sufficient for all applications and reasonably foreseeable uses of the components or systems.

For safety information see the Safety Guide at www.parker.com/safety or call 1-800-CParker.

OFFER OF SALE

The items described in this document are hereby offered for sale by Parker Hannifin Corporation, its subsidiaries or its authorized distributors. This offer and its acceptance are governed by the provisions stated in the detailed "Offer of Sale" available at www.parker.com.

FOR USE ON REFRIGERATION and/or AIR CONDITIONING SYSTEMS ONLY

For more information about our products visit us at www.sporlan.com.
Bulletin 60-15, August 2017, supersedes Bulletin 60-15, August 2004, and all prior publications.

The valve is usually connected to feed into the surge drum above the liquid level. It can also feed into the liquid leg or coil header.

The insert bulb can be installed directly in the shell, surge drum or liquid leg on new or existing installations. Existing float systems can be easily converted by installing the LMC insert bulb in the float chamber.

The Level-Master Control may be installed at any ambient temperature. A thermostatic switch in the heater assembly protects the element from the excessive temperature created by the heater.

Insert Bulb

The insert bulb should be installed at the point where the liquid level is to be maintained. The bulb must be in contact with the refrigerant, i.e., NOT installed in a well. If the insert bulb is projected directly into the surge drum, it should be shielded from possible splash from either the valve feed or the return from the coil. While generally installed in a horizontal position, see Figure 1, it will operate effectively at any angle or vertical position.

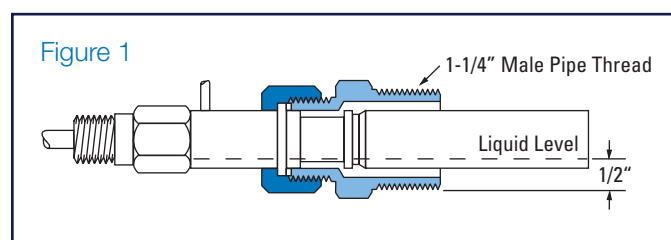

Minor adjustments in liquid level can be made with the expansion valve adjustment stem. The insert bulb assembly is provided with a lock ring and gasket joint so the bulb can be removed without breaking the pipe joint.

Electrical Connections

The heater comes with a two wire neoprene covered cord two feet in length. It runs through a moisture-proof grommet and a 1/2" male conduit connection affixed to the insert bulb assembly, see Figure 2.

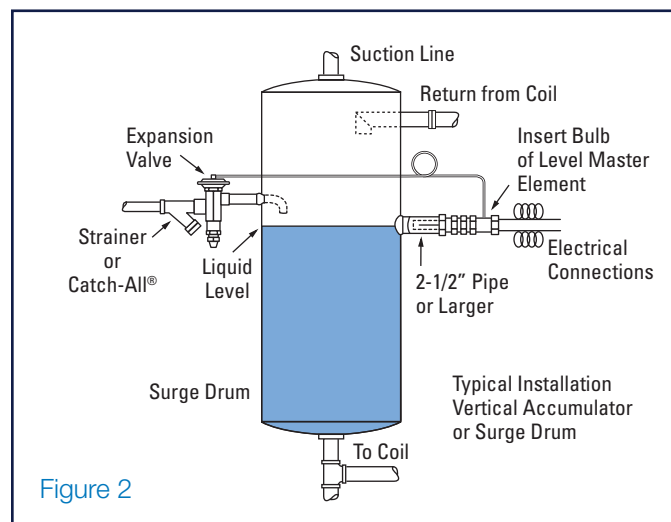

The heater circuit **must** be interrupted when refrigeration is **not** required and the compressor is cycled off. This will prolong the life of the heater thermostat. To accomplish this, the heater is wired **in parallel** (on the compressor side) with the control or power relay, the holding coil of the compressor magnetic starter, or the liquid line solenoid valve.

Design Precautions

Hand Valves

On installations where the valve is isolated from the surge drum by a hand valve, and a 2 to 3 pound pressure drop from the valve outlet to the bulb location is likely, we recommend using an externally equalized valve. (See ordering instructions.)

Oil Return

GENERAL - All reciprocating compressors allow some oil to pass into the discharge line along with the discharge gas. Mechanical oil separators are used extensively; however, they are never completely effective. The untrapped oil passes through the condenser, liquid line, expansion device and finally into the evaporator.

In a properly designed **direct expansion** system, the refrigerant velocity in the evaporator tubes, and in the suction line, is high enough to ensure a continuous return of oil to the compressor crankcase. But, this is not characteristic of flooded systems. Here we purposely design the surge drum for a relatively low vapor velocity to prevent entrainment of liquid refrigerant droplets and consequent carry over into the suction line. This design prevents oil from returning to the low side in the normal manner.

If oil is allowed to concentrate at the insert bulb location of the Sporlan Level-Master Control, overfeeding with possible floodback can occur. The tendency to overfeed is caused by the fact that oil does not convey the heat from the low wattage heater element away from the bulb as rapidly as does pure liquid refrigerant. The bulb pressure is higher than normal and the valve remains in the open or partially open position.

Oil and HFC/HCFC Systems

With HFC and HCFC systems - Refrigerants 134a, 22, 507, etc, the oil and refrigerant are miscible under certain conditions. Mineral oil is partially miscible in liquid R-22 and POE lubricant tends to be more miscible in R-134a and R-507 and other HFC refrigerants. In R-22 systems, a 5% (by weight) of naphthenic mineral oil in liquid refrigerant will remain in solution to approximately 0°F. But at temperatures below 0°F a liquid phase separation occurs. An oil rich solution will appear at the top and a refrigerant rich solution will lie at the bottom of any relatively placid remote bulb chamber. Keep in mind miscibility data for systems using R-22 and HFC refrigerants depends on the oil used and the percentage of oil present in the refrigerant.

In HFC systems, the miscibility of the POE oil depends on the oil approved for the system. Different POE oils will yield different results. POE oils formulated with lower molecular

weight alcohols tend to be more miscible than those with higher molecular weights. Depending on the system, the POE lubricant and refrigerant can be completely miscible at all temperatures normally encountered, or some liquid phase separation could exist for a particular POE oil/ refrigerant combination.

Oil in flooded evaporator applications can produce many effects. Oil as a contaminant will raise the boiling point of the liquid refrigerant if it exists in significant quantity in the evaporator. Oil can change the heat transfer properties with a consequent loss in system capacity. In addition, oil can affect the liquid level control and produce “foaming”, potentially carrying liquid into the suction line.

With a float valve you can normally expect the liquid level in the evaporator to decrease with increasing concentration of oil in the float chamber. This is due to the difference in density between the lighter oil in the chamber and lower balance leg, and the heavier refrigerant/oil mixture in the evaporator. A lower column of dense mixture in the evaporator will balance a higher column of oil in the remote chamber and piping, in a manner similar to a “U” tube manometer with a different liquid in each leg.

With the Sporlan level Master Control the heat transfer rate at the bulb is decreased producing overfeeding and possible flood back. In order to minimize that, we must keep the oil concentration as low as possible in the evaporator, surge drum, and remote insert bulb chamber - if one is used. With HFC/POE oil systems, the oil/refrigerant mixture is likely homogenous (but not necessarily) and you can drain from almost any location in the chiller, surge drum, or remote chamber that is below the liquid level. With R-22 or a possible HCFC/POE oil mixture that is not homogenous, the drain must be located at, or slightly below the surface of the liquid since the oil rich layer is at the top. There are many types of oil return devices:

1. Direct drain into the suction line.
2. Drain through a high pressure liquid warmed heat exchanger.
3. Drain through a heat exchanger with the heat supplied by an electric heater.

The following Figures 3, 4, 5, and 6 are representative of these three methods.

Draining directly into the suction line, as shown in Figure 3, is the simplest method but the hazard of possible floodback to the compressor remains.

Draining through a heat exchanger as indicated in Figure 4, is a popular method since liquid refrigerant floodback problems are minimized by using the warm liquid to vaporize the liquid refrigerant in the oil/refrigerant mixture.

The use of a heat exchanger with an insert electric heater, as shown in Figure 5, is a variation of the preceding method.

In all of the oil return arrangement discussed a solenoid valve should be installed in the drain line and arranged to close when the compressor is not in operation. Otherwise liquid refrigerant could drain from the low side into the compressor crankcase during the off cycle.

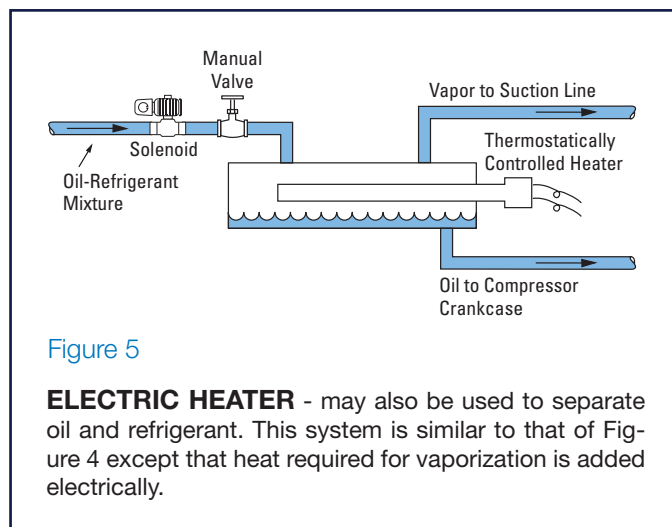
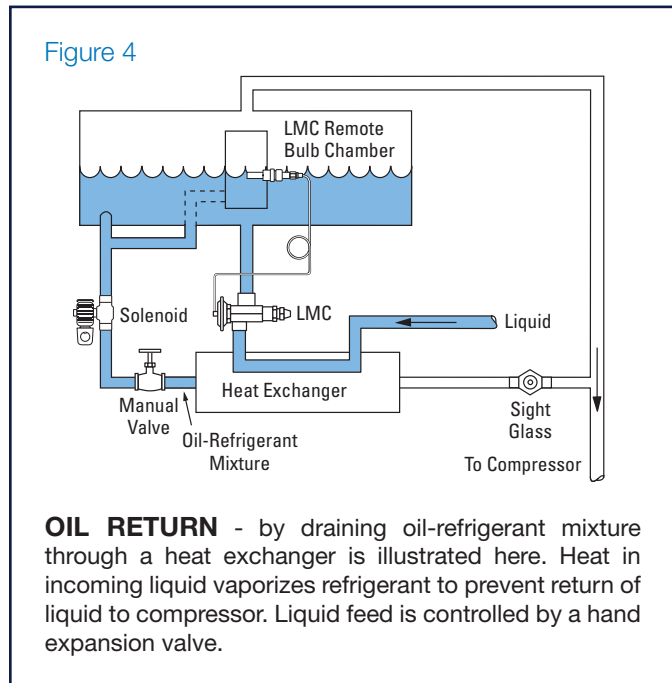
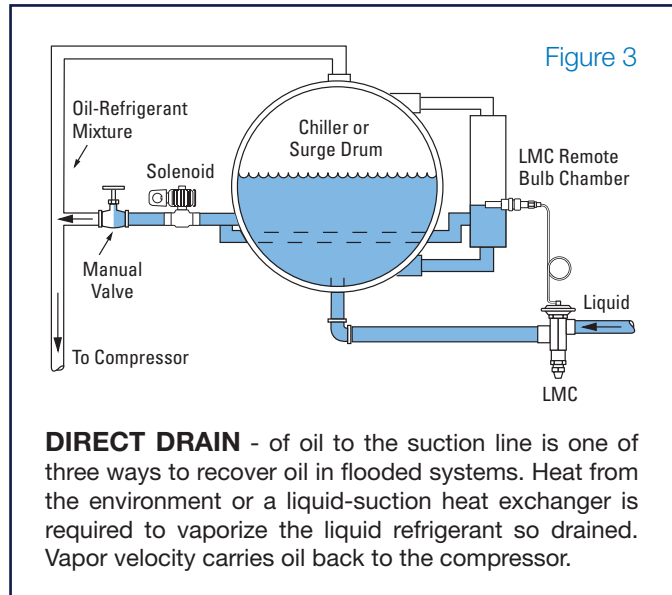

If the insert bulb is installed directly into the surge drum or chiller, then oil return from this point only is necessary. However, if the insert bulb is located in a remote chamber which is tied to the surge drum or chiller with liquid and gas balance lines then oil return should be made from both locations as shown in Figures 3, 4, and 6.

Conclusions - The problem of returning oil from a flooded system is not highly complex and there are undoubtedly other methods in use today that are comparable to those outlined above. Regardless of how it is accomplished, **oil return must be provided**, for proper operation of any flooded system – not only with the Sporlan Level-Master Control but with a float or other type of level control device.

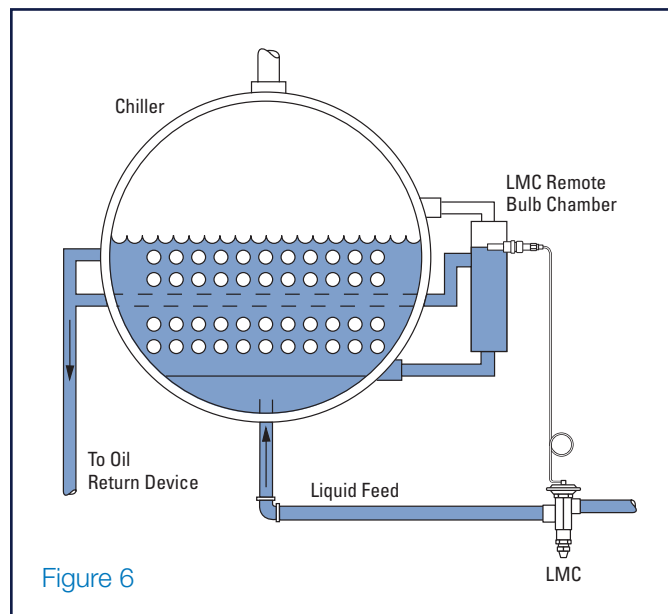

Figure 6

Capacities and Selection For Refrigerants 22, 134a, 507

REFRIGERANT-22 CAPACITIES																					
LMC Valve Types	Nominal Capacity	EVAPORATOR TEMPERATURES (°F)																			
		40° to 0°					-10°					-20°					-40°				
		PRESSURE DROP ACROSS VALVE (POUNDS PER SQUARE INCH)																			
		75	100	125	150	175	100	125	150	175	200	100	125	150	175	200	125	150	175	200	225
P-H	2-1/2	2.16	2.50	2.80	3.06	3.31	2.25	2.52	2.75	2.98	3.19	2.00	2.24	2.44	2.64	2.83	1.54	1.68	1.82	1.95	2.06
	5-1/2	4.85	5.60	6.27	6.86	7.41	5.04	5.64	6.17	6.67	7.12	4.47	5.01	5.48	5.92	6.25	3.45	3.77	4.07	4.35	5.16
	7	6.06	7.00	7.83	8.57	9.26	6.30	7.05	7.71	8.33	8.91	5.59	6.26	6.85	7.40	7.82	4.31	4.71	5.09	5.44	5.77
	11	9.1	10.5	11.7	12.8	13.9	9.45	10.5	11.5	12.5	13.4	8.39	9.35	10.2	11.1	11.7	6.43	7.04	7.61	8.17	8.66
	16	13.2	15.2	17.0	18.6	20.1	13.7	15.3	16.7	18.1	21.5	12.1	13.6	14.9	16.1	19.3	9.35	10.2	11.1	11.8	12.5
M	20	19.2	22.2	24.8	27.2	29.4	19.9	22.3	24.5	26.5	28.3	17.7	19.8	21.7	23.5	24.8	13.6	15.0	16.2	17.3	18.3
	26	22.9	26.5	29.6	32.5	35.0	23.9	26.6	29.3	31.5	33.7	21.2	23.6	25.9	28.0	29.6	16.3	17.9	19.2	20.6	21.9
	34	29.4	34.0	38.0	41.6	45.0	30.6	34.2	37.7	40.5	43.3	27.2	30.4	33.5	35.5	38.0	20.9	23.0	24.7	26.4	28.0
V	42	36.4	42.0	47.0	51.4	55.6	37.8	42.3	46.3	50.0	53.5	33.6	37.5	41.1	44.4	46.9	25.8	28.3	30.6	32.7	34.6
	52	45.0	52.0	58.1	63.7	68.7	46.8	52.3	57.3	61.8	66.2	41.5	46.4	50.9	54.9	58.1	31.9	35.0	37.8	40.4	42.1
	70	63.2	73.0	81.6	89.4	96.6	65.7	73.4	80.5	86.9	92.9	58.3	65.2	71.4	77.2	81.5	44.9	49.1	53.1	56.8	60.4
W	100	86.6	100	112	122	132	90.0	101	110	119	127	79.0	89.1	97.7	106	112	61.5	67.3	72.8	77.8	82.5
	135	124	143	160	175	189	129	144	158	170	182	113	126	138	149	160	87.9	96.3	104	111	118
	180	156	180	201	220	238	162	181	198	214	229	142	159	174	188	201	111	121	131	140	148

REFRIGERANT-134a CAPACITIES																					
LMC Valve Types	Nominal Capacity	EVAPORATOR TEMPERATURES (°F)																			
		40° to 0°						-10°						-20°							
		PRESSURE DROP ACROSS VALVE (POUNDS PER SQUARE INCH)																			
		40	60	80	100	120	80	100	120	140	160	80	100	120	140	160	80	100	120	140	160
P-H	1-1/2	1.57	1.92	2.22	2.48	2.72	1.97	2.20	2.41	2.61	2.79	1.75	1.96	2.15	2.32	2.48	1.20	1.34	1.47	1.59	1.70
	4	3.92	4.80	5.55	6.20	6.79	4.94	5.52	6.05	6.54	6.99	4.38	4.90	5.36	5.79	6.19	3.01	3.36	3.68	3.98	4.25
	5	4.90	6.00	6.93	7.74	8.48	6.18	6.90	7.56	8.17	8.73	5.47	6.12	6.70	7.24	7.74	3.76	4.21	4.61	4.98	5.32
	8	7.35	9.00	10.4	11.6	12.7	9.27	10.4	11.4	12.3	13.1	8.22	9.19	10.1	10.9	11.6	5.64	6.30	6.90	7.46	7.97
	12	11.5	14.0	16.2	18.1	19.8	14.5	16.2	17.7	19.2	20.5	12.9	14.4	15.8	17.0	18.2	8.80	9.84	10.8	11.6	12.4
M	15	15.2	18.6	21.5	24.0	26.3	19.2	21.4	23.5	25.4	27.1	17.0	19.0	20.8	22.5	24.1	11.7	13.1	14.3	15.5	16.5
	20	19.6	24.0	27.7	31.0	34.0	24.7	27.6	30.3	32.7	34.9	21.9	24.5	26.8	29.0	31.0	15.1	16.9	18.5	20.0	21.3
	25	24.5	30.0	34.7	38.8	42.5	30.9	34.5	37.8	40.8	43.7	27.4	30.7	33.6	36.3	38.8	18.8	21.0	23.0	24.8	26.5
V	35	34.3	42.0	48.5	54.2	59.4	43.3	48.5	53.1	57.3	61.3	38.4	42.9	47.0	50.8	54.3	26.3	29.4	32.2	34.8	37.2
	45	44.1	54.1	62.4	69.8	76.5	55.7	62.3	68.2	73.7	78.8	49.3	55.1	60.4	65.2	69.8	33.7	37.6	41.2	44.5	47.6
	55	53.9	66.0	76.2	85.2	93.4	68.0	76.1	83.3	90.0	96.2	60.3	67.4	73.8	79.7	85.2	41.4	46.3	50.7	54.7	58.5
W	80	83.3	102	118	132	144	105	118	129	139	149	93.1	104	114	123	132	63.9	71.5	78.3	84.6	90.4
	110	112	137	158	177	194	141	157	172	186	199	125	140	154	166	177	85.7	95.8	105	113	121

See page 6 for liquid subcooling correction factors.

REFRIGERANT-507 CAPACITIES																					
LMC Valve Types	Nominal Capacity	EVAPORATOR TEMPERATURES (°F)																			
		40° to 0°					-10°					-20°					-40°				
		PRESSURE DROP ACROSS VALVE (POUNDS PER SQUARE INCH)																			
		75	100	125	150	175	100	125	150	175	200	100	125	150	175	200	125	150	175	200	225
P-H	1-1/2	1.30	1.50	1.68	1.84	1.98	1.33	1.48	1.63	1.76	1.88	1.16	1.30	1.42	1.54	1.64	0.89	0.97	1.05	1.13	1.19
	4	3.46	4.00	4.47	4.90	5.29	3.53	3.94	4.32	4.66	4.99	3.08	3.44	3.77	4.08	4.36	2.38	2.60	2.81	3.00	3.19
	6-1/2	5.63	6.50	7.27	7.96	8.60	5.73	6.40	7.01	7.57	8.10	5.01	5.60	6.13	6.62	7.08	3.86	4.23	4.57	4.88	5.18
	9	8.23	9.50	10.6	11.6	12.6	8.32	9.30	10.2	11.0	11.8	7.29	8.15	8.93	9.65	10.3	5.66	6.20	6.69	7.15	7.59
	12	11.3	13.0	14.5	15.9	17.2	11.4	12.8	14.0	15.1	16.2	10.0	11.2	12.3	13.3	14.2	7.72	8.46	9.14	9.77	10.4
M	15	13.7	15.8	17.7	19.4	20.9	13.9	15.6	17.0	18.4	19.7	12.1	13.5	14.8	16.0	17.1	9.39	10.3	11.1	11.9	12.6
	20	17.8	20.6	23.0	25.2	27.3	18.2	20.3	22.2	24.0	25.7	15.8	17.7	19.4	21.0	22.4	12.2	13.4	14.5	15.5	16.4
	25	22.3	25.7	28.7	31.5	34.0	22.7	25.4	27.8	30.0	32.1	19.8	22.2	24.3	26.2	28.0	15.3	16.7	18.1	19.3	20.5
	30	26.8	31.0	34.7	38.0	41.0	27.3	30.6	33.5	36.2	38.7	23.9	26.7	29.2	31.6	33.8	18.4	20.1	21.7	23.2	24.6
V	38	32.9	38.0	42.5	46.5	50.3	33.5	37.5	41.0	44.3	47.4	29.2	32.7	35.8	38.6	41.3	22.6	24.8	26.7	28.6	30.3
	50	44.2	51.0	57.0	62.5	67.5	44.9	50.2	55.0	59.4	63.6	39.3	44.0	48.2	52.0	55.6	30.3	33.2	35.8	38.3	40.6
	70	60.6	70.0	78.3	85.7	92.6	61.7	68.9	75.5	81.6	87.2	53.9	60.2	66.0	71.3	76.2	41.5	45.5	49.2	52.5	55.7
W	100	88.3	102	114	125	135	89.6	100	110	118	127	78.3	87.6	95.9	104	111	59.3	64.9	70.1	75.0	79.5
	130	113	130	145	159	172	114	128	140	151	162	100	112	123	133	142	77.2	84.6	91.4	97.7	104

For evaporator temperatures below -40°F, consult Parker Hannifin, Sporlan Division, Washington, MO 63090
See below for liquid subcooling correction factors.

These ratings are based on vapor free (subcooled) liquid refrigerant entering the expansion valve (100°F for Refrigerants – 22, 134a, and 507 and standard factory setting. Because of the artificial superheat provided by the electric heater, the Level-Master will have a greater capacity than a conventional thermostatic expansion valve. For selections for other refrigerants contact Parker Hannifin, Sporlan Division, Washington, MO 63090.

These factors include corrections for liquid refrigerant density and net refrigerating effect, and are based on an average evaporator temperature of 0°F. However, they may be used for any evaporator temperature from -40°F to 40°F since the variation in the actual factors across this range is insignificant.

EXAMPLE:

At -20°F evaporator, 150 psi pressure drop and 50°F liquid temperature the capacity of an LMC-PVE-11 is... **10.2 X 1.29 = 13.2 tons.**

REFRIGERANT LIQUID TEMPERATURE CORRECTION FACTORS (°F)

Refrigerant	40°	50°	60°	70°	80°	90°	100°	110°	120°	130°	140°
22	1.34	1.29	1.23	1.17	1.12	1.06	1.00	0.94	0.88	0.82	0.76
134a	1.42	1.36	1.29	1.21	1.14	1.07	1.00	0.93	0.85	0.78	0.71
507	1.59	1.50	1.40	1.30	1.20	1.10	1.00	0.89	0.78	0.66	0.51

Ordering Instructions

COMPLETE CONTROL VALVE AND ELEMENT

1. Valve type, per specification table on page 7. If external equalizer is required, add “E” as sixth letter. Example: LMC-HVE-20 or LMC-MFE-15.
2. Connection sizes and tubing lengths, if other than standard.
3. Electrical Characteristics

LMC ELEMENT ONLY

Specify voltage, wattage and type number as shown in “Element Only” column. (A 15 watt heater is supplied as standard. For applications below -60°F evaporating temperature specify a special 25 watt heater.)

ELECTRICAL SPECIFICATIONS

15 watt, 120v or 240v AC or DC.
120v-25w, 240v-25w, 24v-15w or 25w are available on special order.

STANDARD CAPILLARY TUBING LENGTH

10 Feet

REPLACEMENT PARTS

Internal Parts Kits – Same as standard thermostatic expansion valves. Specify valve type, refrigerant and nominal capacity.

HEATER ELEMENT ASSEMBLY

Consists of heater element lead wire protective thermostatic switch, and moisture proof seal. The standard lead wire length is two feet.

Contact Parker Hannifin, Sporlan Division, Washington, Missouri for capillary tubing lengths and heater element lead wire lengths other than standard.

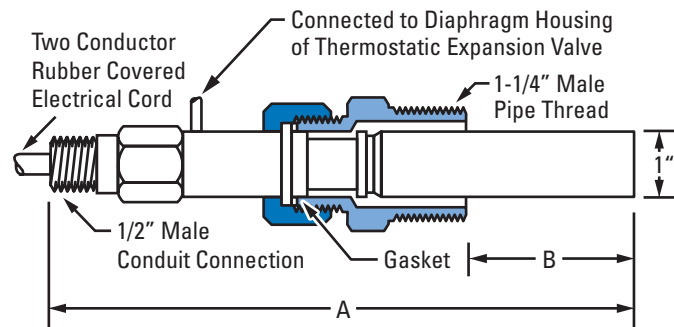

Element Size	Dimensions Inches		Refrigerant		
	A	B	22	134a	507
No. 33	8.88	2.62	P-H	P-H	P-H
No. 63	13.25	7	M-V-W135	M-V-W80	M-V-W100
No. 7	13.25	7	W-180	W-110	W-130

Specifications

REFRIGERANTS - 12, 134a SPECIFICATIONS			
Complete Control Valve & Element		Element Only	
EXTERNAL EQUALIZER	② EXTERNAL EQUALIZER		
Straight Solder Connections			
LMC-PJ-12	—	LMC 33	
Solder Flange Connections			
—	LMC-HFE-8	LMC 33	
LMC-HJE-12	—		
—	LMC-MFE-15		
—	LMC-MFE-20		
LMC-MJE-25	—	LMC 63	
LMC-VJE-35	—		
—	LMC-VFE-45		
LMC-WJE-80	LMC-WFE-80		

REFRIGERANTS - 22 SPECIFICATIONS				
Complete Control Valve & Element		Element Only	Standard Connections ODF Inches Sizes shown in Blue Figures will be furnished unless otherwise specified.	
INTERNAL EQUALIZER	② EXTERNAL EQUALIZER		Inlet	Outlet
Straight Solder Connections				
—	LMC-PVE-2-1/2	LMC 33	1/2, 5/8	5/8, 7/8
—	LMC-PVE-5-1/2		5/8	7/8, 1-1/8, 1-3/8
—	LMC-PVE-7			
—	LMC-PVE-11			
LMC-PV-16	LMC-PVE-16			1-1/8
—	LMC-PVE-20		1-3/8	
Solder Flange Connections				
—	LMC-HVE-2-1/2	LMC 33	1/2, 5/8	5/8, 7/8
—	LMC-HVE-5-1/2			
—	LMC-HVE-7		5/8, 7/8	7/8, 1-1/8
—	LMC-HVE-11			
—	LMC-HVE-16		7/8	7/8 or 1-1/8
LMC-HV-20	LMC-HVE-20			
—	LMC-MVE-26	LMC 63	7/8, ①1-1/8	1-1/8, ①1-3/8
—	LMC-MVE-34		7/8, ①1-1/8	
LMC-MV-42	LMC-MVE-42			
—	LMC-VVE-52		1-1/8, ①1-3/8	1-1/8, ①1-3/8
—	LMC-VVE-70			
—	LMC-VVE-100			
—	LMC-WVE-135			
—	LMC-WVE-180	LMC 7	1-1/8, 1-3/8, 1-5/8, 2-1/8	1-1/8, 1-3/8, 1-5/8, 2-1/8

REFRIGERANTS - 404A & 507 SPECIFICATIONS				
Complete Control Valve & Element		Element Only	Standard Connections ODF Inches Sizes shown in Blue Figures will be furnished unless otherwise specified.	
EXTERNAL EQUALIZER	② EXTERNAL EQUALIZER		Inlet	Outlet
Straight Solder Connections				
—	LMC-PRE-1-1/2	LMC 33	1/2, 5/8	5/8, 7/8
—	LMC-PRE-4		5/8	7/8, 1-1/8, 1-3/8
LMC-PSE-6-1/2	LMC-PRE-6-1/2			
—	LMC-PRE-9		7/8	1-1/8
LMC-PSE-12	LMC-PRE-12			1-3/8
Solder Flange Connections				
LMC-HSE-6-1/2	—	LMC 33	5/8, 7/8	7/8, 1-1/8
—	LMC-HRE-9			
LMC-HSE-12	—		7/8	7/8 or 1-1/8
LMC-MSE-15	LMC-MRE-15	LMC 63	7/8, ①1-1/8	1-1/8, ①1-3/8
LMC-MSE-20	LMC-MRE-20			
LMC-MSE-25	LMC-MRE-25			
LMC-MSE-30	—		7/8, ①1-1/8	
LMC-VSE-38	LMC-VRE-38			
LMC-VSE-50	LMC-VRE-50		1-1/8, ①1-3/8	
LMC-VSE-70	—			
LMC-WSE-100	LMC-WRE-100		1-1/8, 1-3/8, 1-5/8, 2-1/8	1-1/8, 1-3/8, 1-5/8, 2-1/8
—	LMC-WRE-130	LMC 7		

① 1/2", 3/4", or 1" EPT connections also available on request.
 ② Standard External Equalizer Connection available when specified.

Replacement Element Kits

Part Number	Element Size	Application Refrigerants	Capillary Tube Lengths	Electrical Specifications	Sporlan Description
680001	33	R-12/R-134a	10'	120V-15W	LMC-33FL 10' 120V-15W
680003		R-22			LMC-33VL 10' 120V-15W
680005		R-507/R404A			LMC-33RL 10' 120V-15W
680009	R-22	LMC-63VL 10' 120V-15W			
680011	R-507/R404A	LMC-63RL 10' 120V-15W			
680025	33	R-22		240V-15W	LMC-33VL 10' 240V-15W
680027		R-507/R404A		LMC-33RL 10' 240V-15W	
680028				120V-15W	LMC-33SL 10' 120V-15W
680031	63	R-22		240V-15W	LMC-63VL 10' 240V-15W
680033		R-507/R404A		LMC-63RL 10' 240V-15W	
680034			120V-15W	LMC-63SL 10' 120V-15W	
680038	33	R-12/R-134a	240V-15W	LMC-33JL 10' 240V-15W	
680044	63		120V-15W	LMC-63JL 10' 120V-15W	



Parker Hannifin Corporation
Sporlan Division
206 Lange Drive • Washington, MO 63090 USA
phone 636 239 1111
fax 636 239 9130
www.sporlan.com