



aerospace  
climate control  
electromechanical  
filtration  
fluid & gas handling  
hydraulics  
pneumatics  
process control  
sealing & shielding



# CAT 4690-MH/US Metal Hose

Flexible Braided Hose



ENGINEERING YOUR SUCCESS.



Parflex Division - Ravenna, OH

 **WARNING**

FAILURE OR IMPROPER SELECTION OR IMPROPER USE OF THE PRODUCTS AND/OR SYSTEMS DESCRIBED HEREIN OR RELATED ITEMS CAN CAUSE DEATH, PERSONAL INJURY AND PROPERTY DAMAGE.

This document and other information from Parker Hannifin Corporation, its subsidiaries and authorized distributors provide product and/or system options for further investigation by users having technical expertise. It is important that you analyze all aspects of your application and review the information concerning the product or system in the current product catalog. Due to the variety of operating conditions and applications for these products or systems, the user, through its own analysis and testing, is solely responsible for making the final selection of the products and systems and assuring that all performance, safety and warning requirements of the application are met.

The products described herein, including without limitation, product features, specifications, designs, availability and pricing, are subject to change by Parker Hannifin Corporation and its subsidiaries at any time without notice.

**Offer of Sale**

The items described in this document are hereby offered for sale by Parker Hannifin Corporation, its subsidiaries or its authorized distributors. This offer and its acceptance are governed by the provisions stated in the "Offer of Sale".

# Table of Contents

Why Parflex Metal Hoses and Assemblies are Superior .....	1
Metal Hose Size and Performance Specifications .....	2-4
• 9A General Purpose Metal Hose .....	2
• 9M Flexible Metal Hose .....	3
• 9H High Pressure Metal Hose .....	4
How to Build Parflex Metal Hose Assemblies .....	5
Fitting Information .....	6
Flange Information .....	7
Technical Information .....	8-16
Pressure Rating vs. Bend Radius Charts .....	8
Velocity in Metal Hoses .....	9
Working Pressure & Pressure Drop Charts .....	9
Testing, Cleaning & Packaging Chart .....	10
Corrosion Resistance Chart .....	11-12
Do's & Don'ts Illustration Chart .....	13
Length Calculations Illustration Chart .....	14
Metal Hose Selection (STAMPED Form) .....	15
Parker Safety Guide .....	16-19
Offer of Sale .....	20-21

# Parflex Metal Hoses

## The Superior Product

Parflex metal hose assemblies are designed for applications where chemicals and temperature extremes either from media or atmosphere are present. Factory welded and ready to install, these Parflex metal hose assemblies are leak-free, full vacuum hose solutions.

The 9A and 9M Parflex Metal Hose products are constructed with a hydroformed corrugated stainless steel core tube. Hydroforming, which utilizes high pressure water to form the corrugations, minimizes residual stress in the metal and maintains a consistent tube wall thickness throughout the hose.

Any hose assembly is only as good as its weakest link. In the case of a metal hose assembly, the weakest link can be the welding process. The proprietary methods of seam and butt welding, as well as fitting attachment, utilized in Parflex assemblies are second to none and yield a consistent, reliable, leak-free connection.



## Product Features

- Excellent chemical resistance
- Operates in high temperatures
- Sizes 1/4" I.D. up to 6" I.D. (for sizes over 2" I.D., contact Customer Service)
- Hydroformed design yields a uniform wall thickness, promoting even distribution of stress during flexing and reduces concentrated residual stress
- Full Vacuum - Maintains its shape under full vacuum, other hose types collapse
- Fire safety - Maintains its integrity up to 1200°F
- Zero permeation
- Leak-free fitting weld connection

## 9A - Standard

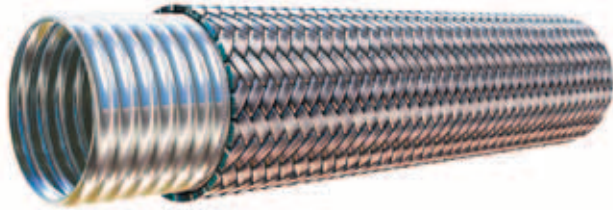

### Features:

- Hydroforming process maintains a more consistent tube wall thickness throughout the hose and maintains a smoother finish than competitive mechanical forming methods
- The brightly annealed tube material used in hydroforming minimizes the risk of Corrosion Crevice Cracking (CCR) failure and increases chemical resistance
- High percentage of braid coverage yields better cycle life and protection against tube damage

### Applications/Markets



- Abrasion and over bending - as a protective cover over wires or other hoses to prevent these problems
- Chemical transfer
- Diesel engine exhaust
- Hot oil and lube lines
- Loading/unloading of light oils, gas, and chemicals
- Petrochemical
- Power Gen
  - Connections for the fuel rail to the combustion cans on gas turbine fuel lines
  - Pump connections
- Pulp & Paper
- Solvent and steam lines

9A General Purpose Hose Metal Hose Size and Performance Specifications						
Inside Diameter (in.)	Number of Braids (#)	Outside Diameter (in.)	Min. Bend Radius (in.)	Working Pressure (psi)	Burst Pressure (psi)	Weight per Foot (lbs.)
	0	0.41		90		0.04
1/4	1	0.47	4.5	1800	7233	0.11
	2	0.53		2700	9100	0.18
3/8	0	0.65		70		0.10
	1	0.71	5.0	1558	6230	0.20
	2	0.77		2336	9345	0.30
1/2	0	0.77		70		0.11
	1	0.83	5.5	1186	4743	0.22
	2	0.89		1779	7115	0.33
5/8	0	0.96		57		0.17
	1	1.02	7.0	1205	4820	0.33
	2	1.08		1808	7230	0.49
3/4	0	1.16		43		0.19
	1	1.22	8.0	898	3591	0.37
	2	1.28		1347	5387	0.55
1	0	1.47		43		0.26
	1	1.53	9.0	718	2872	0.50
	2	1.59		1077	4308	0.74
1-1/4	0	1.75		43		0.29
	1	1.83	10.0	645	2581	0.61
	2	1.91		968	3872	0.93
1-1/2	0	2.08		28		0.47
	1	2.16	11.0	531	2125	0.85
	2	2.24		797	3188	1.23
2	0	2.61		14		0.59
	1	2.69	13.0	449	1797	1.11
	2	2.77		674	2696	1.63
2-1/2 - 6	Contact Customer Service for assistance.					

### Construction

**Tube:** 300 series SS, Annular profile

**Reinforcement:** 300 series SS braid: 0, 1 or 2 layers

### Operating Parameters

**Temperature Range:**  
-380°F to +1200°F (-228°C to +648°C)  
For carbon steel fittings:  
-70°F to +900°F (-57°C to +482°C)

### Working Pressure

Vacuum (30in/Hg) to 2700 psi depending on assembly specifications

### Notes

Hoses greater than 2" I.D. available - Contact the Parflex Division

STAMPED (Hose Selection Criteria) - pg 15

For ordering information, consult "How to Build Parflex Metal Hose Assembly Part Numbers" - pg 5

## 9M - Ultra Flexible

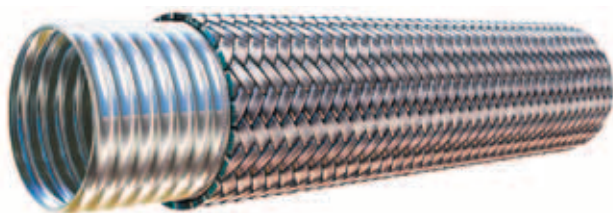

### Features:

- Compressed corrugations for increased flexibility
- Hydroforming process maintains a more consistent tube wall thickness throughout the hose and maintains a smoother finish than competitive mechanical forming methods
- The brightly annealed tube material used in hydroforming minimizes the risk of Corrosion Crevice Cracking (CCR) failure and increases chemical resistance
- High percentage of braid coverage yields better cycle life and protection against tube damage

### Applications/Markets



- Abrasion and over bending - as a protective cover over wires or other hoses to prevent these problems
- Chemical transfer
- Diesel engine exhaust
- Hot oil and lube lines
- Loading/unloading of light oils, gas, and chemicals
- Petrochemical
- Power Gen
  - Connections for the fuel rail to the combustion cans on gas turbine fuel lines
  - Pump connections
- Pulp & Paper
- Solvent and steam lines

9M Flexible Metal Hose Metal Hose Size and Performance Specifications						
Inside Diameter (in.)	Number of Braids (#)	Outside Diameter (in.)	Min. Bend Radius (in.)	Working Pressure (psi)	Burst Pressure (psi)	Weight per Foot (lbs.)
	0	0.42		90		0.07
1/4	1	0.48	3.7	1800	7233	0.14
	2	0.54		2700	9100	0.21
3/8	0	0.65	4.0	70		0.20
	1	0.71		1558	6230	0.30
	2	0.77		2336	9345	0.40
1/2	0	0.77	4.4	70		0.22
	1	0.83		1186	4743	0.33
	2	0.89		1779	7115	0.44
5/8	0	0.96	5.6	57		0.31
	1	1.02		1205	4820	0.47
	2	1.08		1808	7230	0.63
3/4	0	1.16	6.4	43		0.33
	1	1.22		898	3591	0.51
	2	1.28		1347	5387	0.69
1	0	1.47	7.1	43		0.45
	1	1.53		718	2872	0.69
	2	1.63		1077	4308	0.93
1-1/4	0	1.75	7.9	43		0.56
	1	1.83		645	2581	0.88
	2	1.91		968	3872	1.20
1-1/2	0	2.08	8.7	28		0.82
	1	2.16		531	2125	1.20
	2	2.24		797	3188	1.58
2	0	2.61	10.3	14		0.95
	1	2.69		449	1797	1.47
	2	2.77		674	2696	1.99
2-1/2 - 6	Contact Customer Service for assistance.					

### Construction

**Tube:** 300 series SS, Annular profile

**Reinforcement:** 300 series SS braid: 0, 1 or 2 layers

### Operating Parameters

**Temperature Range:**  
-380°F to +1200°F (-228°C to +648°C)  
For carbon steel fittings:  
-70°F to +900°F (-57°C to +482°C)

**Working Pressure**  
Vacuum (30in/Hg) to 2700 psi depending on assembly specifications

### Notes

Hoses greater than 2" I.D. available - Contact the Parflex Division

STAMPED (Hose Selection Criteria) - pg 15

For ordering information, consult "How to Build Parflex Metal Hose Assembly Part Numbers" - pg 5

## 9H - High Pressure

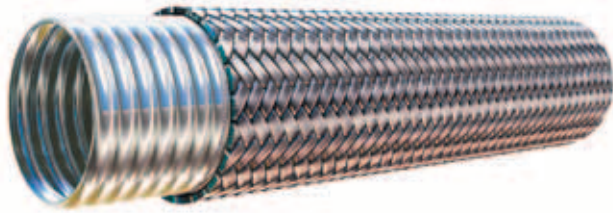

### Features:

- Specially designed to maintain extreme pressure and flexibility
- Helical construction is self-draining
- High percentage of braid coverage yields better cycle life and protection against tube damage

### Applications/Markets



- Abrasion and over bending - as a protective cover over wires or other hoses to prevent these problems
- Chemical transfer
- Diesel engine exhaust
- Hot oil and lube lines
- Loading/unloading of light oils, gas, and chemicals
- Petrochemical
- Power Gen
  - Connections for the fuel rail to the combustion cans on gas turbine fuel lines
  - Pump connections
- Pulp & Paper
- Solvent and steam lines

9H High Pressure Metal Hose  
Metal Hose Size and Performance Specifications

Inside Diameter (in.)	Number of Braids (#)	Outside Diameter (in.)	Min. Bend Radius (in.)	Working Pressure (psi)	Burst Pressure (psi)	Weight per Foot (lbs.)
1/4	1	0.52	5.0	4600	18400	0.21
	2	0.62		5800	23200	0.32
5/16	1	0.62	5.1	4000	16000	0.29
	2	0.74		4800	19200	0.45
3/8	1	0.70	5.5	3800	15200	0.36
	2	0.82		4000	16000	0.57
1/2	1	0.82	5.7	2600	10400	0.43
	2	0.94		3700	14800	0.69
5/8	1	0.97	6.1	2400	9600	0.51
	2	1.09		2700	10800	0.82
3/4	1	1.19	6.5	2000	8000	0.64
	2	1.31		2200	8800	1.03
1	1	1.39	7.9	1500	6000	0.78
	2	1.51		2000	8000	1.25
1-1/4	1	1.75	9.4	1100	4400	1.15
	2	1.87		1600	6400	1.70
1-1/2	1	2.07	12.2	1000	4000	1.45
	2	2.19		1500	6000	2.16

### Construction

**Tube:** 316 SS, Helical Profile

**Reinforcement:** 304 SS Braid  
- 1 or 2 layers

### Operating Parameters

**Temperature Range:**

-380°F to +1200°F (-228°C to +648°C)  
For carbon steel fittings:  
-70°F to +900°F (-57°C to +482°C)

**Working Pressure**

Vacuum (30in/Hg) to 5800 psi depending on assembly specifications

### Notes

STAMPED (Hose Selection Criteria) - pg 15

For ordering information, consult "How to Build Parflex Metal Hose Assembly Part Numbers" - pg 5

## How to Build Parflex Metal Hose Assembly Part Numbers



9A	Hose Series	1	Code #	TU-01*	First and Second End Connection**
9A	9A – General Purpose 9M – Flexible 9H – High Pressure	1	0 – No braid, 321 SS Tube 1 – 304 SS Single braid, 321 SS Tube 2 – 304 SS Double braid, 321 SS Tube 3 – No braid, 316 SS Tube 4 – 304 SS Single braid, 316 SS Tube 5 – 304 SS Double braid, 316 SS Tube 6 – 316 SS Single braid, 321 SS Tube 7 – 316 SS Double braid, 321 SS Tube 8 – 316 SS Single braid, 316 SS Tube 9 – 316 SS Double braid, 316 SS Tube  Only 9A & 9M products are available in the complete range of product options.  9H hose is only available in codes 4 & 5 (1 or 2 304 SS braids, and 316 SS tube)	TU-01*	01 – Male Pipe Thread (with hex) - NPTF MT – Male Pipe Toe (no hex) - NPT 02 – Female Pipe Thread - NPT 03 – Male JIC 37° Flare 06 – Female JIC 37° Flare Swivel 07 – Female Pipe Swivel U7 – Female Pipe Union - NPT TU – Universal Tube Stub JC – Female Oring Face Seal (ORFS) Swivel AL – A-lok® Compression HV – Male VacuSeal™ P6 – CPI™ Compression Q1 – UltraSeal™ Swivel VH – Female VacuSeal™ 9K – Raised Face Weld Neck 150lb Fixed Flange 9Y – Raised Face Weld Neck 300lb Fixed Flange 4K – Schedule 40 Type A Stub with 150lb Lap Joint Flange 1Y – Schedule 40 Type A Stub with 300lb Lap Joint Flange 8K – Raised Face 150lb Fixed Slip-on Flange 8Y – Raised Face 300lb Fixed Slip-on Flange

06	First End Size	06	Second End Size	06	Hose Size	C	Fitting Material	30	Overall Length
-4	= 1/4	-4	= 1/4	-4	= 1/4	Steel	No Material Designation	Expressed in inches	
-6	= 3/8	-6	= 3/8	-6	= 3/8	Stainless Steel	= C		
-8	= 1/2	-8	= 1/2	-8	= 1/2	316 Stainless Steel	= K		
-10	= 5/8	-10	= 5/8	-10	= 5/8	304 SS	is standard material.		
-12	= 3/4	-12	= 3/4	-12	= 3/4	316 SS	is available upon request.		
-16	= 1	-16	= 1	-16	= 1				
-20	= 1-1/4	-20	= 1-1/4	-20	= 1-1/4				
-24	= 1-1/2	-24	= 1-1/2	-24	= 1-1/2				
-32	= 2	-32	= 2	-32	= 2				
-40	= 2-1/2	-40	= 2-1/2	-40	= 2-1/2				

\* Always Alpha Numeric TU01, not 01TU.  
 \*\* Not all fitting configurations are available in full array of sizes.

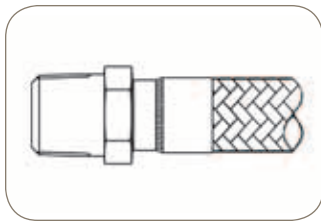

01 - Male Pipe Thread  
(with hex) - NPTF

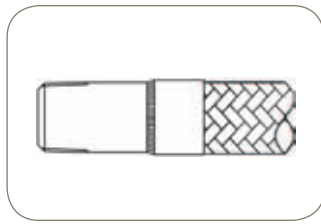

MT - Male Pipe Toe  
(no hex) - NPT

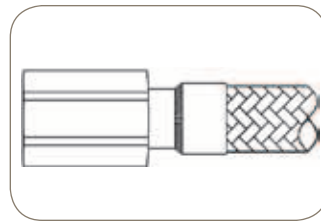

02 - Female Pipe Thread  
NPT

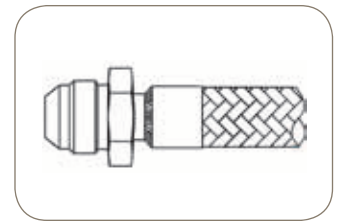

03 - Male JIC 37° Flare

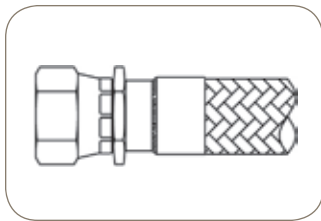

\*06 - Female JIC 37°  
Flare Swivel

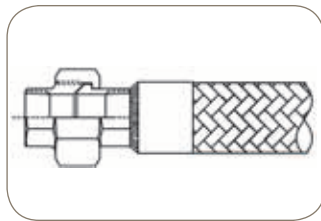

U7 - Female Pipe Union  
NPT

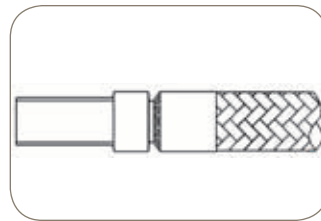

TU - Universal Tube Stub

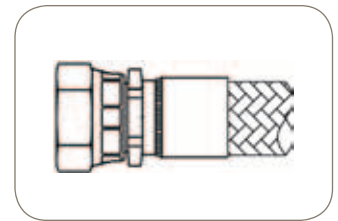

JC - Female Oring Face Seal  
(ORFS) Swivel

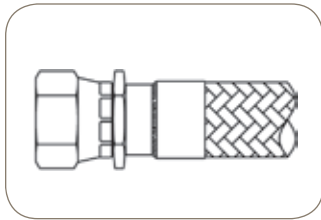

07 - Female Pipe Swivel

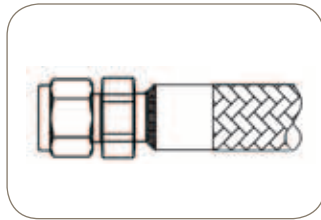

AL - A-lok® Compression

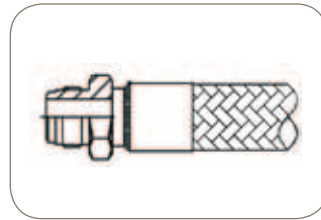

HV - Male VacuSeal™

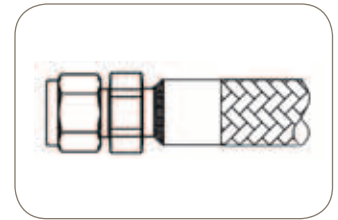

P6 - CPI™ Compression

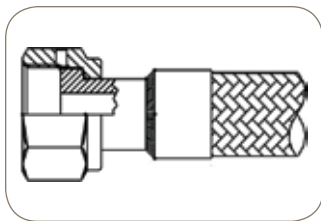

Q1 - UltraSeal™ Swivel

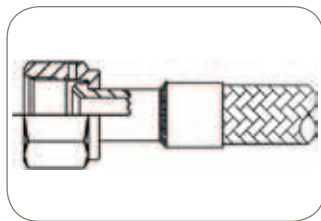

VH - Female VacuSeal™

\*06-Female JIC swivel connections are available with and without the back-up hex. End users must specify fitting preference at the time of quote.

Drawings are for illustration purposes only.

All Instrumentation connections (A-lok®, CPI™, UltraSeal™, VacuSeal™) are Genuine Parker Instrumentation products. For specific information regarding these products, consult Parker Catalog 4200-CPI.

End user must ensure that the selected fittings are chemically compatible with and are able to withstand the pressure and temperatures of the fluid media, the surrounding environment and application. Reference Safety Bulletin 4400-B.1.

# Flange Information

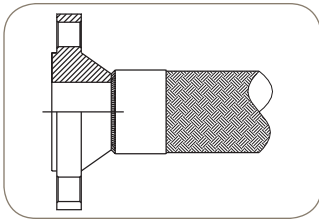

9K - Raised Face Weld Neck 150lb Fixed Flange

9Y - Raised Face Weld Neck 300lb Fixed Flange

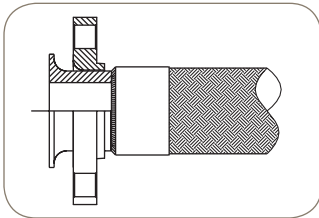

4K - Schedule 40 Type A Stub with 150lb Lap Joint Flange

1Y - Schedule 40 Type A Stub with 300lb Lap Joint Flange

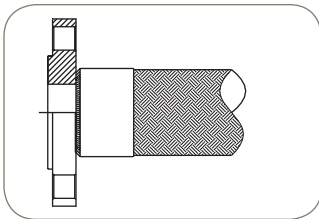

8K - Raised Face 150lb Fixed Slip-on Flange

8Y - Raised Face 300lb Fixed Slip-on Flange

## Flange Identification for Parflex Metal Hose Assemblies

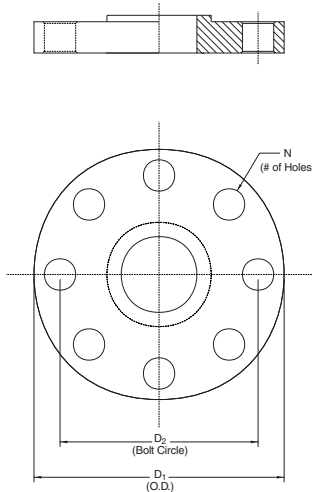

Class	Nominal Size	D <sub>1</sub>	D <sub>2</sub>	N
150	1/2"	3.50	2.38	4
150	3/4"	3.88	2.75	4
150	1"	4.25	3.12	4
150	1 1/4"	4.62	3.50	4
150	1 1/2"	5.00	3.88	4
150	2"	6.00	4.75	4
150	2 1/2"	7.00	5.50	4
300	1/2"	3.75	2.62	4
300	3/4"	4.62	3.25	4
300	1"	4.88	3.50	4
300	1 1/4"	5.25	3.88	4
300	1 1/2"	6.12	4.50	4
300	2"	6.50	5.00	8
300	2 1/2"	7.50	5.88	8

Drawings are for illustration purposes only. All flanges meet ANSI B16.5 specifications.

No hose assembly shall contain two fixed flanges to eliminate hose twisting. Combinations shall be either; 2 floating flange connections or 1 fixed and 1 floating connection.

## Pressure Rating vs. Bend Radius by Hose I.D.

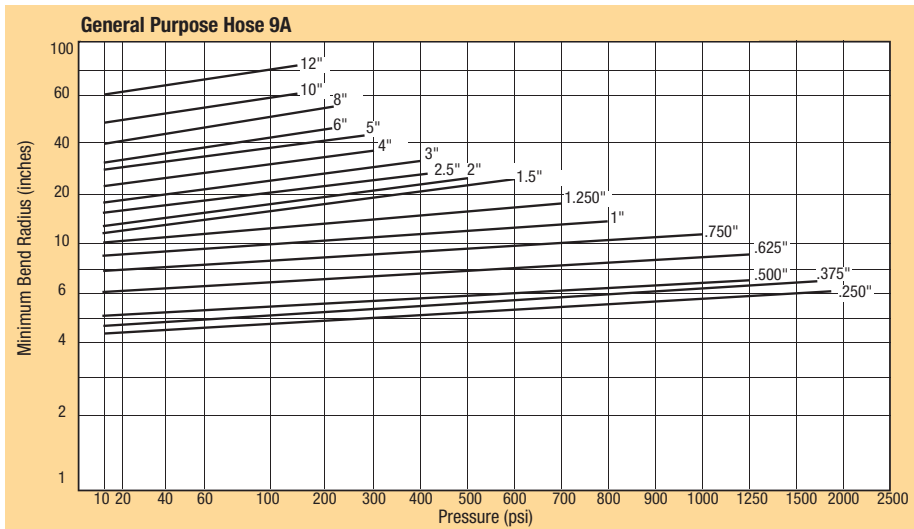

**Notes:**

- The minimum bend radius is measured from the center line of the hose.
- The minimum bend radius increases with pressure (see graphs).
- Pressure is calculated at 70°F ambient temperature.

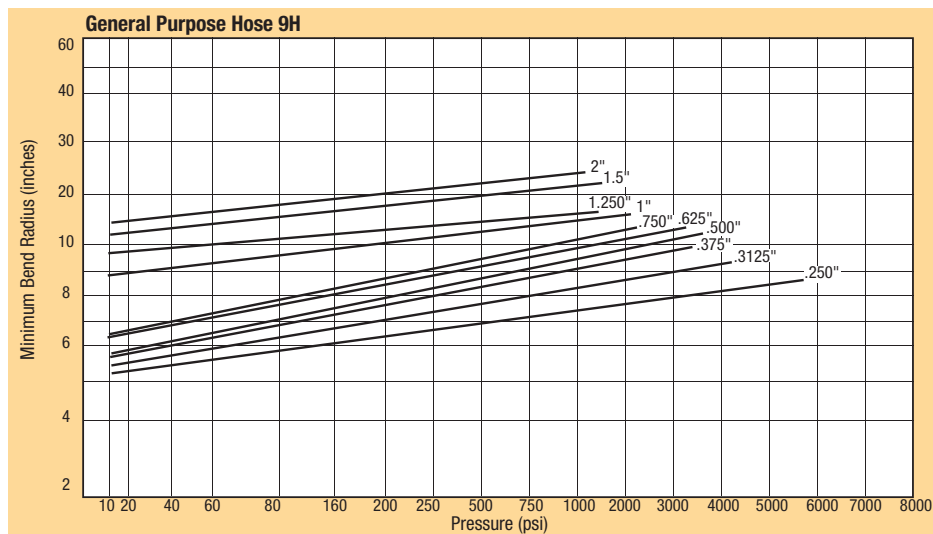
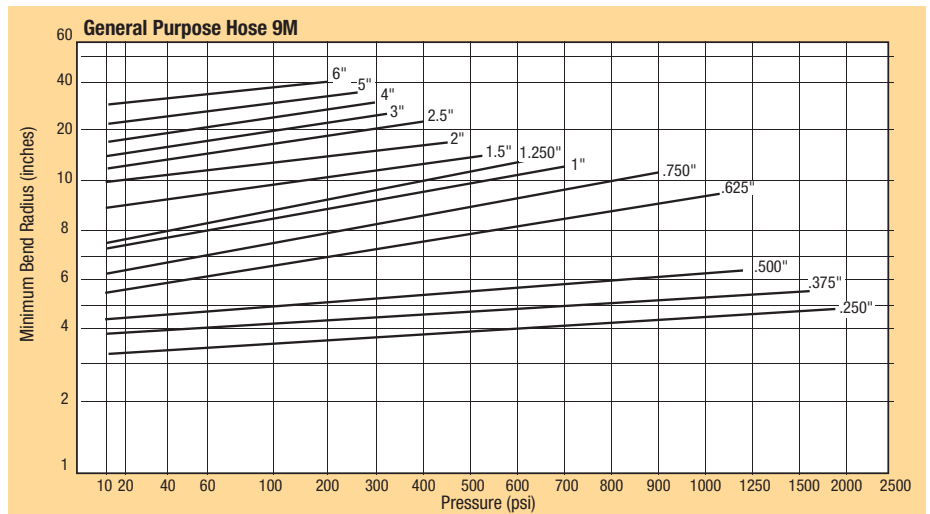

## Velocity in Metal Hose

When gas or liquid being conveyed in a corrugated metal hose exceeds certain limits, resonant vibration can occur. Resonance may cause very rapid failure of the assembly.

In those applications where product velocities exceed the limits shown in the graph below, a revision of the assembly design might include:

- 1) Addition of an interlocked metal hose liner.
- 2) An increase in the corrugated hose I.D.
- 3) A combination of the above.

## Pressure Drop

Pressure drop in a piping system is often a concern of the designer.

Compared to rigid pipe, there is always a greater pressure drop in corrugated metal hose. The following graphics are offered as aids in estimating pressure drop in corrugated hose conveying water and air. The values derived are approximate and apply only to straight line installations. Bends and fittings in the hose assembly can increase the pressure drop.

Installation Configuration	Maximum Product Velocity (Ft./Sec.)			
	Unbraided		Braided	
	Dry Gas	Liquid	Dry Gas	Liquid
Straight Run	100	50	150	75
45° Bend	75	40	115	60
90° Bend	50	25	75	40
180° Bend	25	12	38	19

Working Pressure Derating Factor for Elevated Temperatures				
Temperature	Working Pressure Derating Factor			
°F	304	316	321	Carbon Steel
70	1.00	1.00	1.00	1.00
100	1.00	1.00	1.00	1.00
200	1.00	1.00	1.00	1.00
300	1.00	1.00	1.00	1.00
400	0.93	0.93	1.00	1.00
500	0.86	0.86	0.96	0.95
600	0.81	0.81	0.91	0.87
650	0.79	0.79	0.89	0.85
700	0.77	0.77	0.87	0.83
750	0.75	0.75	0.86	0.81
800	0.74	0.74	0.84	0.78
850	0.72	0.72	0.84	0.74
900	0.71	0.71	0.83	0.70
950	0.69	0.69	0.81	
1000	0.67	0.67	0.81	
1050	0.65	0.65	0.70	
1100	0.62	0.61	0.55	
1150	0.53	0.52	0.41	
1200	0.38	0.38	0.32	

To calculate a working pressure derated for elevated temperature: Multiply the hose working pressure shown in the catalog by the appropriate derating factor from above.

Note: The working pressure of an assembly at elevated temperatures may be affected by fitting type, material and method of attachment.

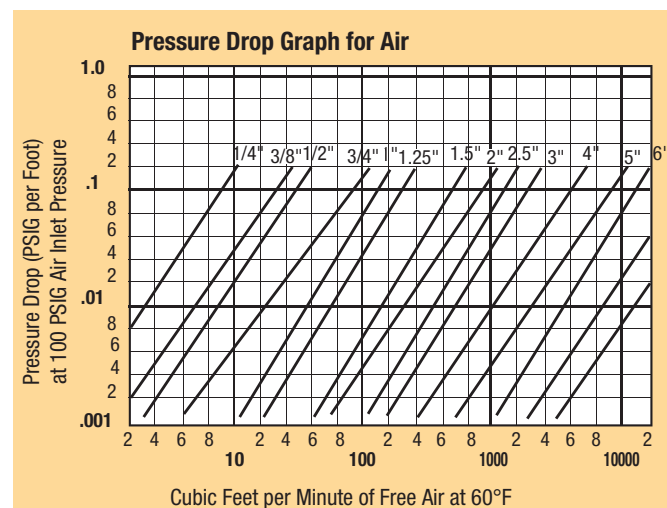
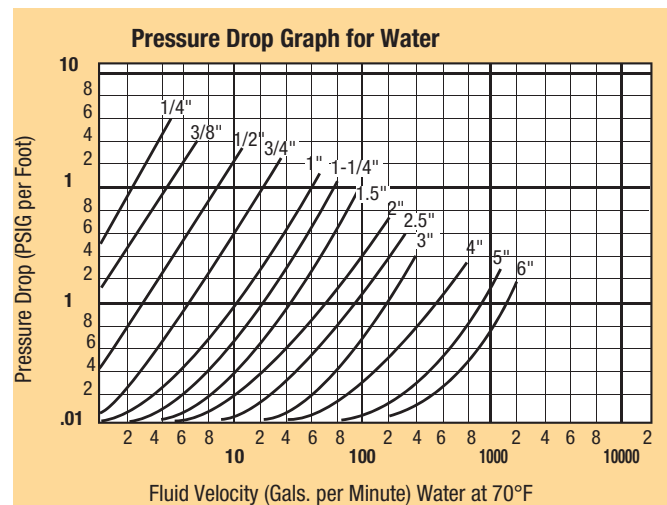

For air inlet pressures other than 100 psig:

$$PD = PD @ 100 \text{ psig} \left( \frac{100 + 14.7}{P + 14.7} \right)$$

## Testing, Cleaning & Packaging

Testing, Cleaning and Packaging of Parflex Metal Hose Assemblies				
Code	Testing <sup>2</sup>	Cleaning	Packaging	Fittings/Welds
P1	General requirement (low pressure air under water)	General requirement	Bulk packed in cardboard box	As welded
P2	Customer specified	General requirement	Customer specified	Welds buffed <sup>1</sup> fittings polished (32 Ra)
P3	General requirement (low pressure air under water)	General requirement	Bulk packed in cardboard box	Welds buffed <sup>1</sup> fittings polished (32 Ra)
P4	General requirement (low pressure air under water)	Water flushed, hot air dried	Plastic mesh protectors - assemblies sealed in plastic bag	Welds buffed <sup>1</sup> fittings polished (32 Ra)
P5	300 PSI Helium under water / 5 minutes	General requirement	Plastic mesh protectors - assemblies sealed in plastic bag	Welds buffed <sup>1</sup> fittings polished (32 Ra)
P6	300 PSI Helium under water / 5 minutes	Oxygen cleaned per CGA G-4.1	Plastic mesh protectors - assemblies sealed in plastic bag	Welds buffed <sup>1</sup> fittings polished (32 Ra)
P7	Customer specified	Oxygen cleaned per CGA G-4.1	Plastic mesh protectors - assemblies sealed in plastic bag	Welds buffed <sup>1</sup> fittings polished (32 Ra)
P8	Helium leak test - leak rate < 1x10 <sup>-5</sup> cc/sec	Water flushed, hot air dried	Plastic mesh protectors - assemblies sealed in plastic bag	Welds buffed <sup>1</sup> fittings polished (32 Ra)
P9	Helium leak test - leak rate < 1x10 <sup>-7</sup> cc/sec	Flushed with alcohol, hot air dried	Plastic mesh protectors - assemblies sealed in plastic bag	Welds buffed <sup>1</sup> fittings polished (32 Ra)
P10	Helium leak test - leak rate < 1x10 <sup>-9</sup> cc/sec	Flushed with alcohol, hot air dried	Plastic mesh protectors - assemblies sealed in plastic bag	Welds buffed <sup>1</sup> fittings polished (32 Ra)
P11	Customer specified	Customer specified	Customer specified	Customer specified

### Footnotes

1. Buffing of welds will remove any heat discoloration due to welding, marker on hose, etc. All welds are argon purged.
2. With any gas under water test, the presence of bubbles would indicate failure.

# Corrosion Resistance Chart

**Caution:** This information is offered only as a guide. Actual service life can only be determined by the end user by testing under all extreme conditions and other analysis. See Parker Safety Guide on pages 17-20.

**Ratings:** 1 – Excellent Resistance  
 2 – Good Resistance  
 3 – Fair or Conditional Resistance  
 X – Not Recommended

**Notes:** (A) Ratings are based on ambient temperature  
 (B) No rating indicates no data available

	T321	T316
Acetate Solvents (crude)	1	2
Acetate Solvents (pure)	1	1
Acetic Acid 80%	1	1
Acetic Acid 50%	2	1
Acetic Acid 20%	2	1
Acetic Acid 10%	1	1
Acetic Anhydride	2	2
Acetone	1	1
Acetylene	1	1
<b>Alcohols</b>		
Amyl Alcohol	2	2
Benzyl Alcohol	1	1
Butyl Alcohol	1	1
Diacetone Alcohol	2	2
Ethyl Alcohol	2	2
Hexyl Alcohol	–	–
Isobutyl Alcohol	–	–
Isopropyl Alcohol	2	2
Methyl Alcohol	2	2
Octyl Alcohol	–	–
Propyl Alcohol	1	1
<b>Aluminum</b>		
Aluminum Chloride	X	X
Aluminum Fluoride (sat.)	X	2
Aluminum Nitrate (sat.)	2	2
Aluminum Potassium Sulfate	X	2
Aluminum Sulfate (sat.)	2	2
Alum	X	2
<b>Ammonia</b>		
Ammonia Anhydrous	2	1
Ammonia Gas	1	1
Ammonia Nitrate	–	–
<b>Ammonium</b>		
Ammonium Bifluoride	–	–
Ammonium Carbonate (sat.)	2	2
Ammonium Casenite	–	–
Ammonium Chloride (sat.)	X	X
Ammonium Hydroxide (sat.)	2	2
Ammonium Nitrate	–	–
Ammonium Phosphate	–	–
Ammonium Sulfate (10%-40%)	X	2
Aniline	1	1
Arsenic Acid	2	2
<b>Barium</b>		
Barium Carbonate (sat.)	2	2
Barium Chloride	X	2
Barium Hydroxide	2	2
Barium Sulfate	2	2
Barium Sulfide	2	2
Beer	1	1
Benzaldehyde	2	2

	T321	T316
Benzene, Benzol	2	2
Benzene	–	–
Benzoic Acid	2	2
Black Liquor	2	2
Bleach (12.5% chlorine)	–	X
Borax	2	1
Boric Acid	–	–
Brake Fluid	1	1
Brine Acid	–	–
Bromic Acid	–	–
Bromine Liquid	X	X
Butadene, Butylene	2	2
Butane	2	2
Butyl Acetate	2	2
Butyric Acid	2	2
<b>Calcium</b>		
Calcium Bisulfate	X	2
Calcium Bisulfide	–	–
Calcium Bisulfite	2	2
Calcium Carbonate	1	2
Calcium Chloride	–	–
Calcium Hydroxide	2	2
Calcium Hypochlorite (sat.)	X	2
<b>Carbon</b>		
Carbon Bisulfide	2	2
Carbon Dioxide (dry)	2	2
Carbon Dioxide (wet)	2	2
Carbon Disulfide	2	2
Carbon Monoxide	1	1
Carbon Tetrachloride	1	1
Carbonic Acid	2	2
Castor Oil	2	2
Caustic Potash	–	–
Cellosolves	2	2
Chlorine (liquid)	–	–
Chloroform	–	1
Chlorosulfonic Acid	X	X
Chromic Acid 50%	3	2
Citric Acid	–	–
Clorox (bleach) 5.5% CL	–	2
Coke Oven Gas	2	2
<b>Copper</b>		
Copper Chloride	X	X
Copper Cyanide	2	2
Copper Sulfate (sat.)	–	2
Cresylic Acid	2	2
Cyclohexane	2	2
Detergents	1	2
Dextrose	–	–
Diesel Fuels	1	1
Diethylamine	2	2

	T321	T316
Disodium Phosphate	–	1
Ethers	1	1
<b>Ethyl</b>		
Ethyl Acetate	2	2
Ethyl Chloride	1	1
<b>Ethylene</b>		
Ethylene Chloride	–	–
Ethylene Dichloride	2	2
Ethylene Glycol	2	2
Ethylene Oxide	2	2
Fatty Acids	–	1
<b>Ferric</b>		
Ferric Chloride	X	X
Ferric Hydroxide	1	1
Ferric Nitrate (10%-50%)	2	2
Ferric Sulfate	–	–
<b>Ferrous</b>		
Ferrous Chloride (sat.)	X	X
Ferrous Sulfate	2	2
Fluoboric Acid	–	–
Formaldehyde (50%)	1	1
Formic Acid (Anhyd)	–	–
<b>Freon</b>		
Freon 11	2	2
Freon 12 (wet)	2	2
Freon 22	2	2
Fruit Juice	2	2
Fuel Oils	2	2
Furfural	2	2
<b>Gasoline</b>		
Refined Gasoline	2	2
Sour Gasoline	2	2
Gelatine	2	2
Glucose	2	2
Glue	2	2
Glycerine	1	1
Glycol	2	2
Green Liquor	–	–
Heptane	2	2
Hexane	1	1
Hydrobromic Acid (50%)	X	X
Hydrobromic Acid (20%)	X	X
Hydrochloric Acid (20%)	X	X
Hydrochloric Acid (37%)	X	X
Hydrocyanic Acid	2	2
Hydrofluoric Acid	X	2
Hydrofluosilicic Acid	X	2
<b>Hydrogen</b>		
Hydrogen Peroxide (50%)	2	–
Hydrogen Sulfide (Aqueous)	X	2
Hydrogen Chloride (Gas, Dry)	–	–

	T321	T316
Hydrogen Gas	1	1
Hypochlorous Acid	X	X
Iodine	X	X
Isopropyl Ether	1	2
Jet Fuel (JP3, JP4, JP5)	2	2
Kerosene	2	2
Ketones	2	2
Lactic Acid (25%)	-	-
Lactic Acid (80%)	2	-
Lard Oil	2	2
Lead		
Lead Acetate	2	2
Lead Chloride	2	2
Lead Sulfate	2	2
Lime Sulphur	2	2
Linoleic Acid	2	2
Linseed Oil	2	2
Lubricants (Oil)	2	2
Magnesium		
Magnesium Carbonate	2	2
Magnesium Chloride	-	-
Magnesium Hydroxide	1	1
Magnesium Nitrate	2	2
Magnesium Oxide	-	-
Magnesium Sulfate	2	2
Maleic Acid	2	2
Mercuric		
Mercuric Chloride	X	-
Mercuric Cyanide	2	2
Mercury	1	1
Methane	1	1
Methanol	2	2
Methyl		
Methyl Bromide	2	2
Methyl Ethyl Ketone	2	2
Methyl Isobutyl Ketone	2	2
Methyl Methacrylate	2	2
Methylene Chloride	-	-
Milk	1	1
Mineral Oil	1	2
Muriatic Acid	X	X
Naptha	2	2
Napthalene	1	1
Nickel		
Nickel Chloride	-	-
Nickel Sulfate	2	2
Nitric		
Nitric Acid (100%)	-	-
Nitric Acid (50%)	1	-
Nitric Acid (30%)	1	-
Nitrobenzene	2	2
Oils		
Castor Oil	2	2
Coconut Oil	2	2
Corn Oil	-	2
Cotton Seed Oil	3	2
Fuel Oil	2	2
Linseed Oil	2	2
Mineral Oil	1	2
Silicone Oil	2	2
Vegetable Oil	1	1
Oleic Acid	-	1
Oleum	2	2
Oxalic Acid (sat.)	X	X

	T321	T316
Oxygen	2	2
Palmitic Acid	2	2
Paraffin	2	2
Perchlorethylene	-	-
Petroleum	2	2
Phenol (Carbolic Acid)	-	1
Phosphoric Acid		
Phosphoric Acid (25%-50%)	-	-
Phosphoric Acid (50%-85%)	1	
Photographic Solutions	1	1
Phthalic Anhydride	1	1
Picric Acid	2	2
Plating Solutions		
Brass Plating Solution	-	2
Cadmium Plating Solution	-	2
Chrome 40% Plating Solution	-	2
Copper (Cyanide) Plat. Solution	-	-
Gold Plating Solution	-	1
Iron Plating Solution	-	-
Lead Plating Solution	1	1
Nickel Plating Solution	1	1
Silver Plating Solution	1	1
Tin Plating Solution	X	X
Zinc Plating Solution	-	-
Potassium		
Potassium Acetate	-	-
Potassium Bicarbonate (30%)	1	1
Potassium Carbonate (50%)	1	1
Potassium Chlorate (30%)	2	1
Potassium Chloride (30%)	-	-
Potassium Chromate (30%)	2	2
Potassium Cyanide Sol. (30%)	2	2
Potassium Dichromate (30%)	1	1
Potassium Hydroxide (90%)	X	-
Potassium Nitrate (80%)	2	2
Potassium Permanganate (20%)	2	2
Potassium Sulfate (10%)	-	-
Propane	2	2
Propylene Glycol	2	2
Propylene Oxide	-	-
Pyridine	2	2
Pyrogallic Acid	2	2
Silver Nitrate	2	1
Soap Solutions	2	2
Sodium		
Sodium Acetate	2	2
Sodium Bicarbonate (20%)	1	1
Sodium Bisulfate	-	-
Sodium Bisulfite	-	-
Sodium Borate	2	2
Sodium Perborate (10%)	2	2
Sodium Carbonate	-	-
Sodium Chlorate	-	-
Sodium Chloride	-	-
Sodium Cyanide	-	-
Sodium Dichromate	2	2
Sodium Hydroxide (70%)	2	2
Sodium Hydroxide (50%)	1	-
Sodium Hydroxide (30%)	1	1
Sodium Hypochlorite	X	X
Sodium Metaphosphate	2	2
Sodium Nitrate	-	-
Sodium Perborate (10%)	2	2
Sodium Peroxide (10%)	2	2

	T321	T316
Sodium Silicate	2	2
Sodium Sulfate	-	1
Sodium Sulfide (50%)	-	2
Sodium Thiosulphate	2	2
Stannic Chloride	X	X
Stannous Chloride	X	-
Steam	-	-
Stearic Acid	2	1
Stoddard Solvent	2	2
Sugar Liquors (cane)	2	2
Sugar Liquors (beet)	1	1
Sulfate Liquors	-	2
Sulfite Liquors	2	2
Sulphur Chloride	-	-
Sulphur Dioxide (dry)	-	2
Sulphur Trioxide	-	2
Sulfuric Acid (to 10%)	X	X
Sulfuric Acid (10%-75%)	-	-
Sulfurous Acid	X	-
Tannic Acid	2	2
Tanning Liquors	1	1
Tartaric Acid	1	1
Titanium Tetrachloride	-	-
Toluene	1	1
Tetrahydrofuran	1	2
Tomato Juice	2	2
Trichloroethylene	-	-
Triethanolamine	2	2
Triethylamine	2	2
Trisodium Phosphate	-	-
Turpentine	1	1
Urea	-	-
Urine	1	1
Vinegar	2	2
Water Acid (mine)	-	-
Water (distilled)	2	2
Water (sea)	2	2
Whiskey	1	1
White Liquor (pulp)	2	2
Wine	1	1
Xylene	2	2
Zinc		
Zinc Chloride	X	2
Zinc Nitrate	2	2
Zinc Sulfate (30%)	1	1

## Do's & Don'ts

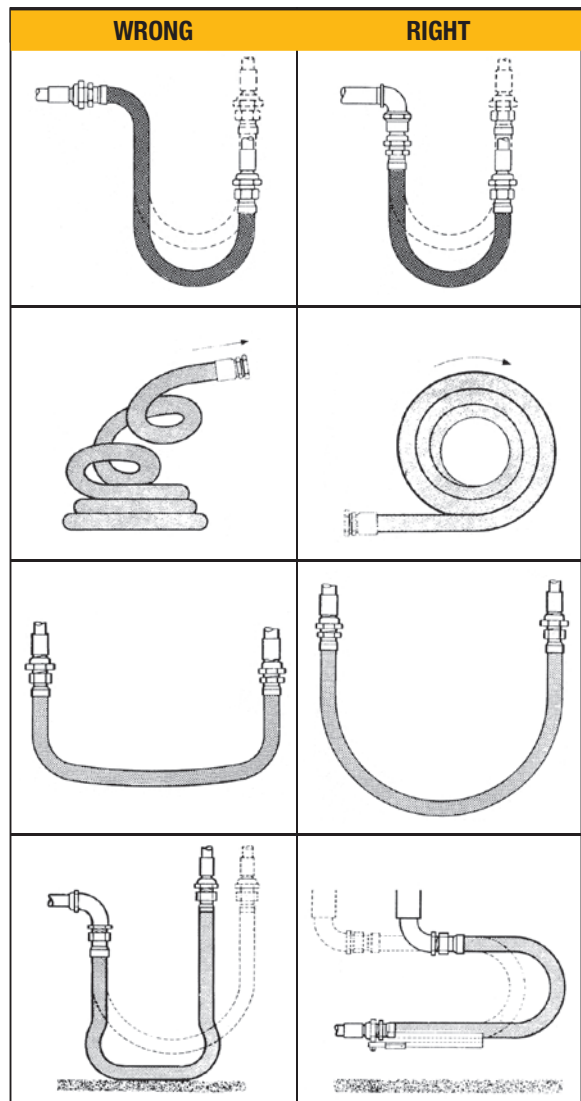
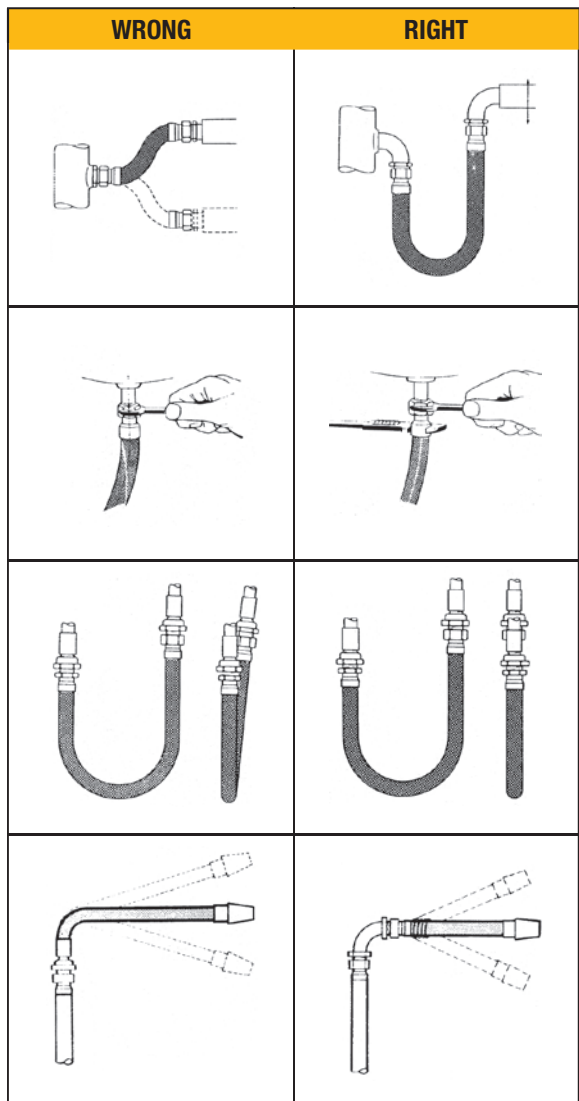

# Length Calculations

For the following formulas:

- L = Live Length of Hose (inches)
- T = Travel (inches)
- S = Hose Outside Diameter (see specification sheets)

Verify that the installed radius is less than the stated Minimum Bend Radius for the hose at the required working pressure.

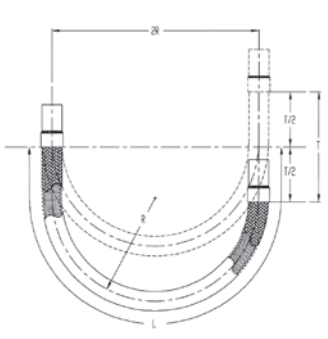
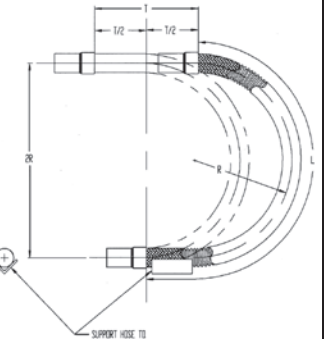
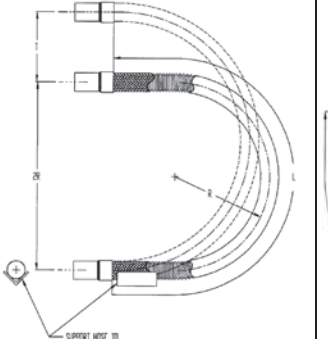
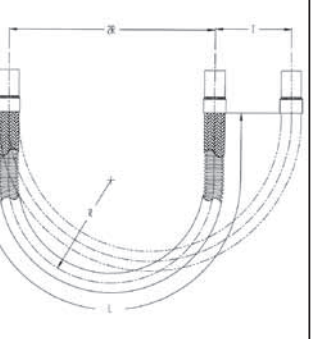
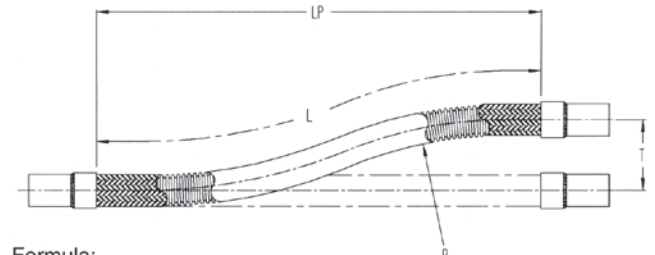
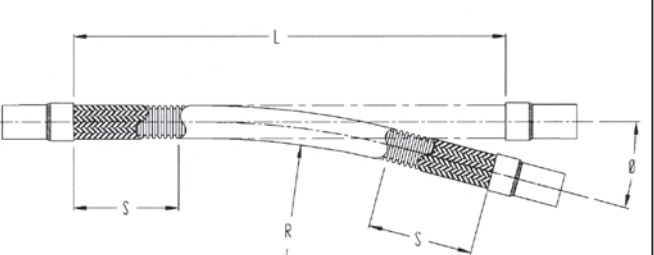
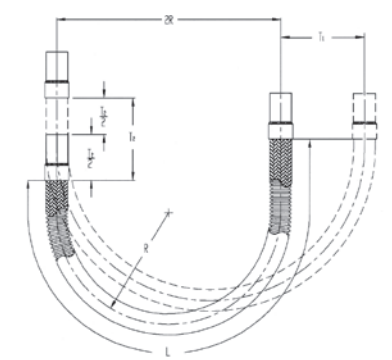
Constant Radius Travelling Loop (A-Loop) Formula: $L = 4R + 1/2T$		Variable Radius Travelling Loop (B-Loop) Formula: $L = 4R + 1.57T$	
<p><b>A. Vertical Travel</b></p> 	<p><b>B. Horizontal Travel</b></p> 	<p><b>A. Vertical Travel</b></p> 	<p><b>B. Horizontal Travel</b></p> 
<p><b>Lateral Offset</b></p>  <p>Formula:  <math>L = \sqrt{20R \times T}</math>  <math>L_p = \sqrt{L^2 - T^2}</math></p> <p><b>Note 1:</b> When the offset motion occurs on both sides of the hose centerline, use total travel in the formula.  <b>Note 2:</b> The offset distance "T" for constant flexing should never exceed 25% of the centerline bend radius.</p>		<p><b>Angular Deflection</b></p>  <p>Formula:  <math>L = 2S + (\theta/57.3)R</math></p>	
<p><b>Vertical Loop with Movement in Two Directions (Combination Loop)</b></p>  <p>Formula:  <math>L = 4R + 1.57T_1 + (T_2/2)</math></p>			

## Metal Hose Selection (STAMPED FORM DESCRIPTION)

Parflex Metal hose is available in various constructions to meet the needs of the diverse applications for which it is intended. To ensure proper product selection, the Parker Hannifin Safety Guide for selecting and using hose, tubing, fittings, and related accessories (Parker Publication No. 4400-B1) along with the STAMPED criteria should be considered.

### SIZE

Select an appropriate hose Inside Diameter for the system considering flow requirements and applicable pressure drop. The length of the hose required to properly complete the connection also needs to be determined. When determining the proper hose length, reference the tables on Length Calculations for Hose Installation - pg 14 and Pressure Rating versus Bend Radius by Hose I.D - pg 8.

### TEMPERATURE

Working Pressures listed are the maximum working pressure of the hose at 70°F. Should system Temperature exceed 70°F, the applicable derating factor should be applied. Consult the Working Pressure Derating Factor for Elevated Temperatures chart - pg 9.

### APPLICATION

Abrasion, climate, heat, flexing, crushing, kinking, and degree of bending are all factors that can impact hose performance and need to be considered during hose selection. To aid in the selection process, please review Do's & Don'ts of Hose Routing - pg. 13, Length Calculations for Hose Installation - pg. 14, and Pressure Rating versus Bend Radius by Hose I.D - pg. 8.

### MEDIA

Identify the media for the application. The various grades of Stainless Steel utilized in the construction of Parflex Metal Hose can react differently to varied media. Consult the Corrosion Resistance Chart - pgs. 11-12 when making Hose & Fitting Alloy decisions.

### PRESSURE

The Working Pressure of the hose selected must meet or exceed the maximum pressure, including any pressure spikes, of the system. Be sure to apply all applicable derating factors to determine actual working pressure for the product selected:

- Temperature - See Working Pressure Derating Factor for Elevated Temperature Chart - pg. 9
- Pressure spikes - Multiply by .17
- Pulsation - Multiply by .50

### END FITTINGS

Identify the end fitting appropriate for the application and the system.

### DYNAMICS

Identify the velocity of the media being utilized in the system. High media velocity, those exceeding limits as specified by the Velocity in Metal Hose table, can result in premature hose failure due to resonant vibration. High velocity of abrasive materials can also lead to premature hose failure.

All charts and tables referenced above can be found in the General Technical section of this catalog.

**The working pressure of all Parflex Metal Hose assemblies is equal to the pressure rating of the lowest pressure rated component.**



**Parker Safety Guide for Selecting and Using Hose, Tubing, Fittings and Related Accessories**  
**Publication No. 4400-B.1**  
**Revised: November 2007**

**WARNING:** Failure or improper selection or improper use of hose, tubing, fittings, assemblies, or related accessories ("Products") can cause death, personal injury and property damage. Possible consequences of failure or improper selection or improper use of these Products include but are not limited to:

- Fittings thrown off at high speed.
- High velocity fluid discharge.
- Explosion or burning of the conveyed fluid.
- Electrocutation from high voltage electric power lines.
- Contact with suddenly moving or falling objects that are controlled by the conveyed fluid.
- Injections by high-pressure fluid discharge.
- Dangerously whipping hose.
- Contact with conveyed fluids that may be hot, cold, toxic, or otherwise injurious.
- Sparking or explosion caused by static electricity buildup or other sources of electricity.

Before selecting or using any of these Products, it is important that you read and follow the instructions below. Only Hose from Parker's Stratoflex Products Division is approved for in-flight aerospace applications.

## 1.0 GENERAL INSTRUCTIONS

**1.1 Scope:** This safety guide provides instructions for selecting and using (including assembling, installing, and maintaining) these Products. For convenience, all rubber and/or thermoplastic products commonly called "hose" or "tubing" are called "Hose" in this safety guide. All assemblies made with Hose are called "Hose Assemblies". All products commonly called "fittings", "couplings" or "adapters" are called "Fittings". All related accessories (including crimping and swaging machines and tooling) are called "Related Accessories". This safety guide is a supplement to and is to be used with the specific Parker publications for the specific Hose, Fittings and Related Accessories that are being considered for use. Parker publications are available at [www.parker.com](http://www.parker.com). SAE J1273 ([www.sae.org](http://www.sae.org)) and ISO 17165 2 ([www.ansi.org](http://www.ansi.org)) also provide recommended practices for hydraulic Hose Assemblies.

**1.2 Fail-Safe:** Hose, Hose Assemblies and Fittings can and do fail without warning for many reasons. Design all systems and equipment in a fail safe mode, so that failure of the Hose, Hose Assembly or Fitting will not endanger persons or property.

**1.3 Distribution:** Provide a copy of this safety guide to each person responsible for selecting or using Hose and Fitting products. Do not select or use Parker Hose or Fittings without thoroughly reading and understanding this safety guide as well as the specific Parker publications for the Products.

**1.4 User Responsibility:** Due to the wide variety of operating conditions and applications for Hose and Fittings, Parker does not represent or warrant that any particular Hose or Fitting is suitable for any specific end use system. This safety guide does not analyze all technical parameters that must be considered in selecting a product. The user, through its own analysis and testing, is solely responsible for:

- Making the final selection of the Products.
- Assuring that the user's requirements are met and that the application presents no health or safety hazards.
- Providing all appropriate health and safety warnings on the equipment on which the Products are used.
- Assuring compliance with all applicable government and industry standards.

**1.5 Additional Questions:** Call the appropriate Parker technical service department if you have any questions or require any additional information. See the Parker publication for the Products being considered or used, or call 1 800 CPARKER, or go to [www.parker.com](http://www.parker.com), for telephone numbers of the appropriate technical service department.

## 2.0 HOSE AND FITTING SELECTION INSTRUCTIONS

**2.1 Electrical Conductivity:** Certain applications require that the Hose be nonconductive to prevent electrical current flow. Other applications require the Hose and the Fittings and the Hose/Fitting interface to be sufficiently conductive to drain off static electricity. Extreme care must be exercised when selecting Hose and Fittings for these or any other applications in which electrical conductivity or nonconductivity is a factor.

The electrical conductivity or nonconductivity of Hose and Fittings is dependent upon many factors and may be susceptible to change. These factors include but are not limited to the various materials used to make the Hose and the Fittings, Fitting finish (some Fitting finishes are electrically conductive while others are nonconductive), manufacturing methods (including moisture control), how the Fittings contact the Hose, age and amount of deterioration or damage or other changes, moisture content of the Hose at any particular time, and other factors.

The following are considerations for electrically nonconductive and conductive Hose. For other applications consult the individual catalog pages and the appropriate industry or regulatory standards for proper selection.

**2.1.1 Electrically Nonconductive Hose:** Certain applications require that the Hose be nonconductive to prevent electrical current flow or to maintain electrical isolation. For applications that require Hose to be electrically nonconductive, including but not limited to applications near high voltage electric lines, only special nonconductive Hose can be used. The manufacturer of the equipment in which the nonconductive Hose is to be used must be consulted to be certain that the Hose and Fittings that are selected are proper for the application. Do not use any Parker Hose or Fittings for any such application requiring nonconductive Hose, including but not limited to applications near high voltage electric lines, unless (i) the application is expressly approved in the Parker technical publication for the product, (ii) the Hose is marked "nonconductive", and (iii) the manufacturer of the equipment on which the Hose is to be used specifically approves the particular Parker Hose and Fittings for such use.

**2.1.2 Electrically Conductive Hose:** Parker manufactures special Hose for certain applications that require electrically conductive Hose.

Parker manufactures special Hose for conveying paint in airless paint spraying applications. This Hose is labeled "Electrically Conductive Airless Paint Spray Hose" on its layline and packaging. This Hose must be properly connected to the appropriate Parker Fittings and properly grounded in order to dissipate dangerous static charge buildup, which occurs in all airless paint spraying applications. Do not use any other Hose for airless paint spraying, even if electrically conductive. Use of any other Hose or failure to properly connect the Hose can cause a fire or an explosion resulting in death, personal injury, and property damage.

Parker manufactures a special Hose for certain compressed natural gas ("CNG") applications where static electricity buildup may occur. Parker CNG Hose assemblies comply with the requirements of ANSI/IAS NGV 4.2-1999; CSA 12.52-M99, "Hoses for Natural Gas Vehicles and Dispensing Systems" ([www.ansi.org](http://www.ansi.org)). This Hose is labeled "Electrically Conductive for CNG Use" on its layline and packaging. This Hose must be properly connected to the appropriate Parker Fittings and properly grounded in order to dissipate dangerous static charge buildup, which occurs in, for example, high velocity CNG dispensing or

transfer. Do not use any other Hose for CNG applications where static charge buildup may occur, even if electrically conductive. Use of other Hoses in CNG applications or failure to properly connect or ground this Hose can cause a fire or an explosion resulting in death, personal injury, and property damage. Care must also be taken to protect against CNG permeation through the Hose wall. See section 2.6, Permeation, for more information. Parker CNG Hose is intended for dispenser and vehicle use at a maximum temperature of 180°F (82°C). Parker CNG Hose should not be used in confined spaces or unventilated areas or areas exceeding 180°F (82°C). Final assemblies must be tested for leaks. CNG Hose Assemblies should be tested on a monthly basis for conductivity per ANSI/IAS NGV 4.2-1999; CSA 12.52-M99.

Parker manufactures special Hose for aerospace in flight applications. Aerospace in flight applications employing Hose to transmit fuel, lubricating fluids and hydraulic fluids require a special Hose with a conductive inner tube. This Hose for in flight applications is available only from Parker's Stratoflex Products Division. Do not use any other Parker Hose for in flight applications, even if electrically conductive. Use of other Hoses for in flight applications or failure to properly connect or ground this Hose can cause a fire or an explosion resulting in death, personal injury and property damage. These Hose assemblies for in flight applications must meet all applicable aerospace industry, aircraft engine & aircraft requirements.

**2.2 Pressure:** Hose selection must be made so that the published maximum working pressure of the Hose and Fittings are equal to or greater than the maximum system pressure. The maximum working pressure of a Hose Assembly is the lower of the respective published maximum working pressures of the Hose and the Fittings used. Surge pressures or peak transient pressures in the system must be below the published maximum working pressure for the Hose. Surge pressures and peak pressures can usually only be determined by sensitive electrical instrumentation that measures and indicates pressures at millisecond intervals. Mechanical pressure gauges indicate only average pressures and cannot be used to determine surge pressures or peak transient pressures. Published burst pressure ratings for Hose is for manufacturing test purposes only and is no indication that the Product can be used in applications at the burst pressure or otherwise above the published maximum recommended working pressure.

**2.3 Suction:** Hoses used for suction applications must be selected to insure that the Hose will withstand the vacuum and pressure of the system. Improperly selected Hose may collapse in suction application.

**2.4 Temperature:** Be certain that fluid and ambient temperatures, both steady and transient, do not exceed the limitations of the Hose. Temperatures below and above the recommended limit can degrade Hose to a point where a failure may occur and release fluid. Properly insulate and protect the Hose Assembly when routing near hot objects (e.g. manifolds). Do not use any Hose in any application where failure of the Hose could result in the conveyed fluids (or vapors or mist from the conveyed fluids) contacting any open flame, molten metal, or other potential fire ignition source that could cause burning or explosion of the conveyed fluids or vapors.

**2.5 Fluid Compatibility:** Hose Assembly selection must assure compatibility of the Hose tube, cover, reinforcement, and Fittings with the fluid media used. See the fluid compatibility chart in the Parker publication for the product being considered or used. This information is offered only as a guide. Actual service life can only be determined by the end user by testing under all extreme conditions and other analysis. Hose that is chemically compatible with a particular fluid must be assembled using Fittings and adapters containing likewise compatible seals.

**2.6 Permeation:** Permeation (that is, seepage through the Hose) will occur from inside the Hose to outside when Hose is used with gases, liquid and gas fuels, and refrigerants (including but not limited to such materials as helium, diesel fuel, gasoline, natural gas, or LPG). This permeation may result in high concentrations of vapors which are potentially flammable, explosive, or toxic, and in loss of fluid. Dangerous explosions, fires, and other hazards can result when using the wrong Hose for such applications. The system designer must take into ac-

count the fact that this permeation will take place and must not use Hose if this permeation could be hazardous. The system designer must take into account all legal, government, insurance, or any other special regulations which govern the use of fuels and refrigerants. Never use a Hose even though the fluid compatibility is acceptable without considering the potential hazardous effects that can result from permeation through the Hose Assembly.

Permeation of moisture from outside the Hose to inside the Hose will also occur in Hose assemblies, regardless of internal pressure. If this moisture permeation would have detrimental effects (particularly, but not limited to refrigeration and air conditioning systems), incorporation of sufficient drying capacity in the system or other appropriate system safeguards should be selected and used.

**2.7 Size:** Transmission of power by means of pressurized fluid varies with pressure and rate of flow. The size of the components must be adequate to keep pressure losses to a minimum and avoid damage due to heat generation or excessive fluid velocity.

**2.8 Routing:** Attention must be given to optimum routing to minimize inherent problems (kinking or flow restriction due to Hose collapse, twisting of the Hose, proximity to hot objects or heat sources). For additional routing recommendations see SAE J1273 and ISO 17165-2. Hose Assemblies have a finite life and if possible, should be installed in a manner that allows for ease of inspection and future replacement. Rubber Hose because of its relative short life, should not be used in residential and commercial buildings for HVAC (heating, ventilating and air conditioning) applications.

**2.9 Environment:** Care must be taken to insure that the Hose and Fittings are either compatible with or protected from the environment (that is, surrounding conditions) to which they are exposed. Environmental conditions including but not limited to ultraviolet radiation, sunlight, heat, ozone, moisture, water, salt water, chemicals and air pollutants can cause degradation and premature failure.

**2.10 Mechanical Loads:** External forces can significantly reduce Hose life or cause failure. Mechanical loads which must be considered include excessive flexing, twist, kinking, tensile or side loads, bend radius, and vibration. Use of swivel type Fittings or adapters may be required to insure no twist is put into the Hose. Unusual applications may require special testing prior to Hose selection.

**2.11 Physical Damage:** Care must be taken to protect Hose from wear, snagging, kinking, bending smaller than minimum bend radius and cutting, any of which can cause premature Hose failure. Any Hose that has been kinked or bent to a radius smaller than the minimum bend radius, and any Hose that has been cut or is cracked or is otherwise damaged should be removed and discarded.

**2.12 Proper End Fitting:** See instructions 3.2 through 3.5. These recommendations may be substantiated by testing to industry standards such as SAE J517 for hydraulic applications, or MIL-A-5070, AS1339, or AS3517 for Hoses from Parker's Stratoflex Products Division for aerospace applications.

**2.13 Length:** When establishing a proper Hose length, motion absorption, Hose length changes due to pressure, and Hose and machine tolerances and movement must be considered.

**2.14 Specifications and Standards:** When selecting Hose and Fittings, government, industry, and Parker specifications and recommendations must be reviewed and followed as applicable.

**2.15 Hose Cleanliness:** Hose components may vary in cleanliness levels. Care must be taken to insure that the Hose Assembly selected has an adequate level of cleanliness for the application.

**2.16 Fire Resistant Fluids:** Some fire resistant fluids that are to be conveyed by Hose require use of the same type of Hose as used with petroleum base fluids. Some such fluids require a special Hose, while a few fluids will not work with any Hose at all. See instructions 2.5 and 1.5. The wrong Hose may fail after a very short service. In addition, all liquids but pure water may burn fiercely under certain conditions, and even pure water leakage may be hazardous.

**2.17 Radiant Heat:** Hose can be heated to destruction without contact by such nearby items as hot manifolds or molten metal. The same heat source may then initiate a fire. This can occur despite the presence of cool air around the Hose.

**2.18 Welding or Brazing:** When using a torch or arc welder in close proximity to hydraulic lines, the hydraulic lines should be removed or shielded with appropriate fire resistant materials. Flame or weld spatter could burn through the Hose and possibly ignite escaping fluid resulting in a catastrophic failure. Heating of plated parts, including Hose Fittings and adapters, above 450°F (232°C) such as during welding, brazing or soldering may emit deadly gases.

**2.19 Atomic Radiation:** Atomic radiation affects all materials used in Hose assemblies. Since the long-term effects may be unknown, do not expose Hose assemblies to atomic radiation.

**2.20 Aerospace Applications:** The only Hose and Fittings that may be used for in flight aerospace applications are those available from Parker's Stratoflex Products Division. Do not use any other Hose or Fittings for in flight applications. Do not use any Hose or Fittings from Parker's Stratoflex Products Division with any other Hose or Fittings, unless expressly approved in writing by the engineering manager or chief engineer of Stratoflex Products Division and verified by the user's own testing and inspection to aerospace industry standards.

**2.21 Unlocking Couplings:** Ball locking couplings or other Fittings with quick disconnect ability can unintentionally disconnect if they are dragged over obstructions, or if the sleeve or other disconnect member, is bumped or moved enough to cause disconnect. Threaded Fittings should be considered where there is a potential for accidental uncoupling.

### 3.0 HOSE AND FITTING ASSEMBLY & INSTALLATION INSTRUCTIONS

**3.1 Component Inspection:** Prior to assembly, a careful examination of the Hose and Fittings must be performed. All components must be checked for correct style, size, catalog number, and length. The Hose must be examined for cleanliness, obstructions, blisters, cover looseness, kinks, cracks, cuts or any other visible defects. Inspect the Fitting and sealing surfaces for burrs, nicks, corrosion or other imperfections. Do NOT use any component that displays any signs of nonconformance.

**3.2 Hose and Fitting Assembly:** Do not assemble a Parker Fitting on a Parker Hose that is not specifically listed by Parker for that Fitting, unless authorized in writing by the engineering manager or chief engineer of the appropriate Parker division. Do not assemble a Parker Fitting on another manufacturer's Hose or a Parker Hose on another manufacturer's Fitting unless (i) the engineering manager or chief engineer of the appropriate Parker division approves the Assembly in writing or that combination is expressly approved in the appropriate Parker literature for the specific Parker product, and (ii) the user verifies the Assembly and the application through analysis and testing. For Parker Hose that does not specify a Parker Fitting, the user is solely responsible for the selection of the proper Fitting and Hose Assembly procedures. See instruction 1.4.

To prevent the possibility of problems such as leakage at the Fitting or system contamination, it is important to completely remove all debris from the cutting operation before installation of the Fittings. The Parker published instructions must be followed for assembling the Fittings on the Hose. These instructions are provided in the Parker Fitting catalog for the specific Parker Fitting being used, or by calling 1 800 CPARKER, or at [www.parker.com](http://www.parker.com).

**3.3 Related Accessories:** Do not crimp or swage any Parker Hose or Fitting with anything but the listed swage or crimp machine and dies in accordance with Parker published instructions. Do not crimp or swage another manufacturer's Fitting with a Parker crimp or swage die unless authorized in writing by the engineering manager or chief engineer of the appropriate Parker division.

**3.4 Parts:** Do not use any Parker Fitting part (including but not limited to socket, shell, nipple, or insert) except with the cor-

rect Parker mating parts, in accordance with Parker published instructions, unless authorized in writing by the engineering manager or chief engineer of the appropriate Parker division.

**3.5 Field Attachable/Permanent:** Do not reuse any field attachable Hose Fitting that has blown or pulled off a Hose. Do not reuse a Parker permanent Hose Fitting (crimped or swaged) or any part thereof. Complete Hose Assemblies may only be reused after proper inspection under section 4.0. Do not assemble Fittings to any previously used hydraulic Hose that was in service, for use in a fluid power application.

**3.6 Pre-Installation Inspection:** Prior to installation, a careful examination of the Hose Assembly must be performed. Inspect the Hose Assembly for any damage or defects. DO NOT use any Hose Assembly that displays any signs of nonconformance.

**3.7 Minimum Bend Radius:** Installation of a Hose at less than the minimum listed bend radius may significantly reduce the Hose life. Particular attention must be given to preclude sharp bending at the Hose to Fitting juncture. Any bending during installation at less than the minimum bend radius must be avoided. If any Hose is kinked during installation, the Hose must be discarded.

**3.8 Twist Angle and Orientation:** Hose Assembly installation must be such that relative motion of machine components does not produce twisting.

**3.9 Securement:** In many applications, it may be necessary to restrain, protect, or guide the Hose to protect it from damage by unnecessary flexing, pressure surges, and contact with other mechanical components. Care must be taken to insure such restraints do not introduce additional stress or wear points.

**3.10 Proper Connection of Ports:** Proper physical installation of the Hose Assembly requires a correctly installed port connection insuring that no twist or torque is transferred to the Hose when the Fittings are being tightened or otherwise during use.

**3.11 External Damage:** Proper installation is not complete without insuring that tensile loads, side loads, kinking, flattening, potential abrasion, thread damage or damage to sealing surfaces are corrected or eliminated. See instruction 2.10.

**3.12 System Checkout:** All air entrapment must be eliminated and the system pressurized to the maximum system pressure (at or below the Hose maximum working pressure) and checked for proper function and freedom from leaks. Personnel must stay out of potential hazardous areas while testing and using.

**3.13 Routing:** The Hose Assembly should be routed in such a manner so if a failure does occur, the escaping media will not cause personal injury or property damage. In addition, if fluid media comes in contact with hot surfaces, open flame or sparks, a fire or explosion may occur. See section 2.4.

#### 3.14 Ground Fault Equipment Protection Devices (GFEPDs):

**WARNING! Fire and Shock Hazard:** To minimize the danger of fire if the heating cable of a Multitube bundle is damaged or improperly installed, use a Ground Fault Equipment Protection Device. Electrical fault currents may be insufficient to trip a conventional circuit breaker.

For ground fault protection, the IEEE 515:1989 ([www.ansi.org](http://www.ansi.org)) standard for heating cables recommends the use of GFEPDs with a nominal 30 milliampere trip level for "piping systems in classified areas, those areas requiring a high degree of maintenance, or which may be exposed to physical abuse or corrosive atmospheres".

### 4.0 HOSE AND FITTING MAINTENANCE & REPLACEMENT INSTRUCTIONS

**4.1** Even with proper selection and installation, Hose life may be significantly reduced without a continuing maintenance program. The severity of the application, risk potential from a possible Hose failure, and experience with any Hose failures in the application or in similar applications should determine the frequency of the inspection and the replacement for the Products so that Products are re-

placed before any failure occurs. A maintenance program must be established and followed by the user and, at minimum, must include instructions 4.2 through 4.7.

**4.2 Visual Inspection Hose/Fitting:** Any of the following conditions require immediate shut down and replacement of the Hose Assembly:

- Fitting slippage on Hose;
- Damaged, cracked, cut or abraded cover (any reinforcement exposed);
- Hard, stiff, heat cracked, or charred Hose;
- Cracked, damaged, or badly corroded Fittings;
- Leaks at Fitting or in Hose;
- Kinked, crushed, flattened or twisted Hose; and
- Blistered, soft, degraded, or loose cover.

**4.3 Visual Inspection All Other:** The following items must be tightened, repaired, corrected or replaced as required:

- Leaking port conditions;
- Excess dirt buildup;
- Worn clamps, guards or shields; and
- System fluid level, fluid type, and any air entrapment.

**4.4 Functional Test:** Operate the system at maximum operating pressure and check for possible malfunctions and leaks. Personnel must avoid potential hazardous areas while testing and using the system. See section 2.2.

**4.5 Replacement Intervals:** Hose assemblies and elastomeric seals used on Hose Fittings and adapters will eventually age, harden, wear and deteriorate under thermal cycling and compression set. Hose Assemblies and elastomeric seals should be inspected and replaced at specific replacement intervals, based on previous service life, government or industry recommendations, or when failures could result in unacceptable downtime, damage, or injury risk. See section 1.2. Hose and Fittings may be subjected to internal mechanical and/or chemical wear from the conveying fluid and may fail without warning. The user must determine the product life under such circumstances by testing. Also see section 2.5. See section 1.2.

**4.6 Hose Inspection and Failure:** Hydraulic power is accomplished by utilizing high pressure fluids to transfer energy and do work. Hoses, Fittings and Hose Assemblies all contribute to this by transmitting fluids at high pressures. Fluids under pressure can be dangerous and potentially lethal and, therefore, extreme caution must be exercised when working with fluids under pressure and handling the Hoses transporting the fluids. From time to time, Hose Assemblies will fail if they are not replaced at proper time intervals. Usually these failures are the result of some form of misapplication, abuse, wear or failure to perform proper maintenance. When Hoses fail, generally the high pressure fluids inside escape in a stream which may or may not be visible to the user. Under no circumstances should the user attempt to locate the leak by "feeling" with their hands or any other part of their body. High pressure fluids can and will penetrate the skin and cause severe tissue damage and possibly loss of limb. Even seemingly minor hydraulic fluid injection injuries must be treated immediately by a physician with knowledge of the tissue damaging properties of hydraulic fluid.

If a Hose failure occurs, immediately shut down the equipment and leave the area until pressure has been completely released from the Hose Assembly. Simply shutting down the hydraulic pump may or may not eliminate the pressure in the Hose Assembly. Many times check valves, etc., are employed in a system and can cause pressure to remain in a Hose Assembly even when pumps or equipment are not operating. Tiny holes in the Hose, commonly known as pinholes, can eject small, dangerously powerful but hard to see streams of hydraulic fluid. It may take several minutes or even hours for the pressure to be relieved so that the Hose Assembly may be examined safely.

Once the pressure has been reduced to zero, the Hose Assembly may be taken off the equipment and examined. It must always be replaced if a failure has occurred. Never attempt to patch or repair a Hose Assem-

ply that has failed. Consult the nearest Parker distributor or the appropriate Parker division for Hose Assembly replacement information.

Never touch or examine a failed Hose Assembly unless it is obvious that the Hose no longer contains fluid under pressure. The high pressure fluid is extremely dangerous and can cause serious and potentially fatal injury.

**4.7 Elastomeric seals:** Elastomeric seals will eventually age, harden, wear and deteriorate under thermal cycling and compression set. Elastomeric seals should be inspected and replaced.

**4.8 Refrigerant gases:** Special care should be taken when working with refrigeration systems. Sudden escape of refrigerant gases can cause blindness if the escaping gases contact the eye and can cause freezing or other severe injuries if it contacts any other portion of the body.

**4.9 Compressed natural gas (CNG):** Parker CNG Hose Assemblies should be tested after installation and before use, and at least on a monthly basis per ANSI/IAS NGV 4.2-1999; CSA 12.52-M99 Section 4.2 "Visual Inspection Hose/Fitting". The recommended procedure is to pressurize the Hose and check for leaks and to visually inspect the Hose for damage.

**Caution:** Matches, candles, open flame or other sources of ignition shall not be used for Hose inspection. Leak check solutions should be rinsed off after use.

## 5.0 HOSE STORAGE

**5.1 Age Control:** Hose and Hose Assemblies must be stored in a manner that facilitates age control and first-in and first-out usage based on manufacturing date of the Hose and Hose Assemblies. The shelf life of rubber Hose or Hose Assemblies that have passed visual inspection and a proof test is 10 years (40 quarters) from the date of manufacture. The shelf life of thermoplastic and polytetrafluoroethylene Hose or Hose Assemblies is considered to be unlimited.

**5.2 Storage:** Stored Hose and Hose Assemblies must not be subjected to damage that could reduce their expected service life and must be placed in a cool, dark and dry area with the ends capped. Stored Hose and Hose Assemblies must not be exposed to temperature extremes, ozone, oils, corrosive liquids or fumes, solvents, high humidity, rodents, insects, ultraviolet light, electromagnetic fields or radioactive materials.

## OFFER OF SALE

The items described in this document and other documents and descriptions provided by Parker Hannifin Corporation, its subsidiaries and its authorized distributors (“Seller”) are hereby offered for sale at prices to be established by Seller. This offer and its acceptance by any customer (“Buyer”) shall be governed by all of the following Terms and Conditions. Buyer’s order for any item described in its document, when communicated to Seller verbally, or in writing, shall constitute acceptance of this offer. All goods or work described will be referred to as “Products”.

- 1. Terms and Conditions.** Seller’s willingness to offer Products, or accept an order for Products, to or from Buyer is expressly conditioned on Buyer’s assent to these Terms and Conditions and to the terms and conditions found on-line at [www.parker.com/saleterms/](http://www.parker.com/saleterms/). Seller objects to any contrary or additional term or condition of Buyer’s order or any other document issued by Buyer.
- 2. Price Adjustments; Payments.** Prices stated on the reverse side or preceding pages of this document are valid for 30 days. After 30 days, Seller may change prices to reflect any increase in its costs resulting from state, federal or local legislation, price increases from its suppliers, or any change in the rate, charge, or classification of any carrier. The prices stated on the reverse or preceding pages of this document do not include any sales, use, or other taxes unless so stated specifically. Unless otherwise specified by Seller, all prices are F.O.B. Seller’s facility, and payment is due 30 days from the date of invoice. After 30 days, Buyer shall pay interest on any unpaid invoices at the rate of 1.5% per month or the maximum allowable rate under applicable law.
- 3. Delivery Dates; Title and Risk; Shipment.** All delivery dates are approximate and Seller shall not be responsible for any damages resulting from any delay. Regardless of the manner of shipment, title to any products and risk of loss or damage shall pass to Buyer upon tender to the carrier at Seller’s facility (i.e., when it’s on the truck, it’s yours). Unless otherwise stated, Seller may exercise its judgment in choosing the carrier and means of delivery. No deferment of shipment at Buyers’ request beyond the respective dates indicated will be made except on terms that will indemnify, defend and hold Seller harmless against all loss and additional expense. Buyer shall be responsible for any additional shipping charges incurred by Seller due to Buyer’s changes in shipping, product specifications or in accordance with Section 13, herein.
- 4. Warranty.** Seller warrants that the Products sold hereunder shall be free from defects in material or workmanship for a period of twelve months from the date of delivery to Buyer or 2,000 hours of normal use, whichever occurs first. This warranty is made only to Buyer and does not extend to anyone to whom Products are sold after purchased from Seller. The prices charged for Seller’s products are based upon the exclusive limited warranty stated above, and upon the following disclaimer: **DISCLAIMER OF WARRANTY: THIS WARRANTY COMPRISES THE SOLE AND ENTIRE WARRANTY PERTAINING TO PRODUCTS PROVIDED HEREUNDER. SELLER DISCLAIMS ALL OTHER WARRANTIES, EXPRESS AND IMPLIED, INCLUDING MERCHANTABILITY AND FITNESS FOR A PARTICULAR PURPOSE.**
- 5. Claims; Commencement of Actions.** Buyer shall promptly inspect all Products upon delivery. No claims for shortages will be allowed unless reported to the Seller within

10 days of delivery. No other claims against Seller will be allowed unless asserted in writing within 60 days after delivery or, in the case of an alleged breach of warranty, within 30 days after the date within the warranty period on which the defect is or should have been discovered by Buyer. Any action based upon breach of this agreement or upon any other claim arising out of this sale (other than an action by Seller for any amount due to Seller from Buyer) must be commenced within thirteen months from the date of tender of delivery by Seller or, for a cause of action based upon an alleged breach of warranty, within thirteen months from the date within the warranty period on which the defect is or should have been discovered by Buyer.

**6. LIMITATION OF LIABILITY.** UPON NOTIFICATION, SELLER WILL, AT ITS OPTION, REPAIR OR REPLACE A DEFECTIVE PRODUCT, OR REFUND THE PURCHASE PRICE. IN NO EVENT SHALL SELLER BE LIABLE TO BUYER FOR ANY SPECIAL, INDIRECT, INCIDENTAL OR CONSEQUENTIAL DAMAGES ARISING OUT OF, OR AS THE RESULT OF, THE SALE, DELIVERY, NON-DELIVERY, SERVICING, USE OR LOSS OF USE OF THE PRODUCTS OR ANY PART THEREOF, OR FOR ANY CHARGES OR EXPENSES OF ANY NATURE INCURRED WITHOUT SELLER’S WRITTEN CONSENT, EVEN IF SELLER HAS BEEN NEGLIGENT, WHETHER IN CONTRACT, TORT OR OTHER LEGAL THEORY. IN NO EVENT SHALL SELLER’S LIABILITY UNDER ANY CLAIM MADE BY BUYER EXCEED THE PURCHASE PRICE OF THE PRODUCTS.

**7. Contingencies.** Seller shall not be liable for any default or delay in performance if caused by circumstances beyond the reasonable control of Seller.

**8. User Responsibility.** The user, through its own analysis and testing, is solely responsible for making the final selection of the system and Product and assuring that all performance, endurance, maintenance, safety and warning requirements of the application are met. The user must analyze all aspects of the application and follow applicable industry standards and Product information. If Seller provides Product or system options, the user is responsible for determining that such data and specifications are suitable and sufficient for all applications and reasonably foreseeable uses of the Products or systems.

**9. Loss to Buyer’s Property.** Any designs, tools, patterns, materials, drawings, confidential information or equipment furnished by Buyer or any other items which become Buyer’s property, may be considered obsolete and may be destroyed by Seller after two consecutive years have elapsed without Buyer placing an order for the items which are manufactured using such property. Seller shall not be responsible for any loss or damage to such property while it is in Seller’s possession or control.

**10. Special Tooling.** A tooling charge may be imposed for any special tooling, including without limitation, dies, fixtures, molds and patterns, acquired to manufacture Products. Such special tooling shall be and remain Seller's property notwithstanding payment of any charges by Buyer. In no event will Buyer acquire any interest in apparatus belonging to Seller which is utilized in the manufacture of the Products, even if such apparatus has been specially converted or adapted for such manufacture and notwithstanding any charges paid by Buyer. Unless otherwise agreed, Seller shall have the right to alter, discard or otherwise dispose of any special tooling or other property in its sole discretion at any time.

**11. Buyer's Obligation; Rights of Seller.** To secure payment of all sums due or otherwise, Seller shall retain a security interest in the goods delivered and this agreement shall be deemed a Security Agreement under the Uniform Commercial Code. Buyer authorizes Seller as its attorney to execute and file on Buyer's behalf all documents Seller deems necessary to perfect its security interest. Seller shall have a security interest in, and lien upon, any property of Buyer in Seller's possession as security for the payment of any amounts owed to Seller by Buyer.

**12. Improper use and Indemnity.** Buyer shall indemnify, defend, and hold Seller harmless from any claim, liability, damages, lawsuits, and costs (including attorney fees), whether for personal injury, property damage, patent, trademark or copyright infringement or any other claim, brought by or incurred by Buyer, Buyer's employees, or any other person, arising out of: (a) improper selection, improper application or other misuse of Products purchased by Buyer from Seller; (b) any act or omission, negligent or otherwise, of Buyer; (c) Seller's use of patterns, plans, drawings, or specifications furnished by Buyer to manufacture Product; or (d) Buyer's failure to comply with these terms and conditions. Seller shall not indemnify Buyer under any circumstance except as otherwise provided.

**13. Cancellations and Changes.** Orders shall not be subject to cancellation or change by Buyer for any reason, except with Seller's written consent and upon terms that will indemnify, defend and hold Seller harmless against all direct, incidental and consequential loss or damage. Seller may change product features, specifications, designs and availability with notice to Buyer.

**14. Limitation on Assignment.** Buyer may not assign its rights or obligations under this agreement without the prior written consent of Seller.

**15. Entire Agreement.** This agreement contains the entire agreement between the Buyer and Seller and constitutes the final, complete and exclusive expression of the terms of the agreement. All prior or contemporaneous written or oral agreements or negotiations with respect to the subject matter are herein merged.

**16. Waiver and Severability.** Failure to enforce any provision of this agreement will not waive that provision nor will any such failure prejudice Seller's right to enforce that provision in the future. Invalidation of any provision of this agreement by legislation or other rule of law shall not invalidate any other provision herein. The remaining provisions of this agreement will remain in full force and effect.

**17. Termination.** This agreement may be terminated by Seller for any reason and at any time by giving Buyer thirty (30) days written notice of termination. In addition, Seller

may by written notice immediately terminate this agreement for the following: (a) Buyer commits a breach of any provision of this agreement (b) the appointment of a trustee, receiver or custodian for all or any part of Buyer's property (c) the filing of a petition for relief in bankruptcy of the other Party on its own behalf, or by a third party (d) an assignment for the benefit of creditors, or (e) the dissolution or liquidation of the Buyer.

**18. Governing Law.** This agreement and the sale and delivery of all Products hereunder shall be deemed to have taken place in and shall be governed and construed in accordance with the laws of the State of Ohio, as applicable to contracts executed and wholly performed therein and without regard to conflicts of laws principles. Buyer irrevocably agrees and consents to the exclusive jurisdiction and venue of the courts of Cuyahoga County, Ohio with respect to any dispute, controversy or claim arising out of or relating to this agreement. Disputes between the parties shall not be settled by arbitration unless, after a dispute has arisen, both parties expressly agree in writing to arbitrate the dispute.

**19. Indemnity for Infringement of Intellectual Property Rights.** Seller shall have no liability for infringement of any patents, trademarks, copyrights, trade dress, trade secrets or similar rights except as provided in this Section. Seller will defend and indemnify Buyer against allegations of infringement of U.S. patents, U.S. trademarks, copyrights, trade dress and trade secrets ("Intellectual Property Rights"). Seller will defend at its expense and will pay the cost of any settlement or damages awarded in an action brought against Buyer based on an allegation that a Product sold pursuant to this Agreement infringes the Intellectual Property Rights of a third party. Seller's obligation to defend and indemnify Buyer is contingent on Buyer notifying Seller within ten (10) days after Buyer becomes aware of such allegations of infringement, and Seller having sole control over the defense of any allegations or actions including all negotiations for settlement or compromise. If a Product is subject to a claim that it infringes the Intellectual Property Rights of a third party, Seller may, at its sole expense and option, procure for Buyer the right to continue using the Product, replace or modify the Product so as to make it noninfringing, or offer to accept return of the Product and return the purchase price less a reasonable allowance for depreciation. Notwithstanding the foregoing, Seller shall have no liability for claims of infringement based on information provided by Buyer, or directed to Products delivered hereunder for which the designs are specified in whole or part by Buyer, or infringements resulting from the modification, combination or use in a system of any Product sold hereunder. The foregoing provisions of this Section shall constitute Seller's sole and exclusive liability and Buyer's sole and exclusive remedy for infringement of Intellectual Property Rights.

**20. Taxes.** Unless otherwise indicated, all prices and charges are exclusive of excise, sales, use, property, occupational or like taxes which may be imposed by any taxing authority upon the manufacture, sale or delivery of Products.

**21. Equal Opportunity Clause.** For the performance of government contracts and where dollar value of the Products exceed \$10,000, the equal employment opportunity clauses in Executive Order 11246, VEVRAA, and 41 C.F.R. §§ 60-1.4(a), 60-741.5(a), and 60-250.4, are hereby incorporated.

01/09

**Notes:**

**Notes:**



# Parker's Motion & Control Product Groups

At Parker, we're guided by a relentless drive to help our customers become more productive and achieve higher levels of profitability by engineering the best systems for their requirements. It means looking at customer applications from many angles to find new ways to create value. Whatever the motion and control technology need, Parker has the experience, breadth of product and global reach to consistently deliver. No company knows more about motion and control technology than Parker. For further info call 00800 27 27 5374



## Aerospace

### Key Markets

Aftermarket services  
Commercial transports  
Engines  
General & business aviation  
Helicopters  
Launch vehicles  
Military aircraft  
Missiles  
Power generation  
Regional transports  
Unmanned aerial vehicles

### Key Products

Control systems & actuation products  
Engine systems & components  
Fluid conveyance systems & components  
Fluid metering, delivery & atomization devices  
Fuel systems & components  
Fuel tank inerting systems  
Hydraulic systems & components  
Thermal management  
Wheels & brakes



## Automation

### Key Markets

Alternative energy  
Conveyor & material handling  
Factory automation  
Food & beverage  
Life sciences & medical  
Machine tools  
Packaging machinery  
Paper machinery  
Plastics machinery  
Primary metals  
Safety & security  
Semiconductor & electronics  
Transportation & automotive

### Key Products

AC/DC drives & systems  
Air preparation  
Electric actuators, gantry robots & slides  
Human machine interfaces  
Inverters  
Manifolds  
Miniature fluidics  
Pneumatic actuators & grippers  
Pneumatic valves & controls  
Rotary actuators  
Stepper motors, servo motors, drives & controls  
Structural extrusions  
Vacuum generators, cups & sensors



## Climate & Industrial Controls

### Key Markets

Agriculture  
Air conditioning  
Construction Machinery  
Food & beverage  
Industrial machinery  
Life sciences  
Oil & gas  
Precision cooling  
Process  
Refrigeration  
Transportation

### Key Products

Accumulators  
Advanced actuators  
CO<sub>2</sub> controls  
Electronic controllers  
Filter driers  
Hand shut-off valves  
Heat exchangers  
Hose & fittings  
Pressure regulating valves  
Refrigerant distributors  
Safety relief valves  
Smart pumps  
Solenoid valves  
Thermostatic expansion valves



## Filtration

### Key Markets

Aerospace  
Food & beverage  
Industrial plant & equipment  
Life sciences  
Marine  
Mobile equipment  
Oil & gas  
Power generation & renewable energy  
Process  
Transportation  
Water Purification

### Key Products

Analytical gas generators  
Compressed air filters & dryers  
Engine air, coolant, fuel & oil filtration systems  
Fluid condition monitoring systems  
Hydraulic & lubrication filters  
Hydrogen, nitrogen & zero air generators  
Instrumentation filters  
Membrane & fiber filters  
Microfiltration  
Sterile air filtration  
Water desalination & purification filters & systems



## Fluid Connectors

### Key Markets

Aerial lift  
Agriculture  
Bulk chemical handling  
Construction machinery  
Food & beverage  
Fuel & gas delivery  
Industrial machinery  
Life sciences  
Marine  
Mining  
Mobile  
Oil & gas  
Renewable energy  
Transportation

### Key Products

Check valves  
Connectors for low pressure fluid conveyance  
Deep sea umbilicals  
Diagnostic equipment  
Hose couplings  
Industrial hose  
Mooring systems & power cables  
PTFE hose & tubing  
Quick couplings  
Rubber & thermoplastic hose  
Tube fittings & adapters  
Tubing & plastic fittings



## Hydraulics

### Key Markets

Aerial lift  
Agriculture  
Alternative energy  
Construction machinery  
Forestry  
Industrial machinery  
Machine tools  
Marine  
Material handling  
Mining  
Oil & gas  
Power generation  
Refuse vehicles  
Renewable energy  
Truck hydraulics  
Turf equipment

### Key Products

Accumulators  
Cartridge valves  
Electrohydraulic actuators  
Human machine interfaces  
Hybrid drives  
Hydraulic cylinders  
Hydraulic motors & pumps  
Hydraulic systems  
Hydraulic valves & controls  
Hydrostatic steering  
Integrated hydraulic circuits  
Power take-offs  
Power units  
Rotary actuators  
Sensors



## Instrumentation

### Key Markets

Alternative fuels  
Biopharmaceuticals  
Chemical & refining  
Food & beverage  
Marine & shipbuilding  
Medical & dental  
Microelectronics  
Nuclear Power  
Offshore oil exploration  
Oil & gas  
Pharmaceuticals  
Power generation  
Pulp & paper  
Steel  
Water/wastewater

### Key Products

Analytical Instruments  
Analytical sample conditioning products & systems  
Chemical injection fittings & valves  
Fluoropolymer chemical delivery fittings, valves & pumps  
High purity gas delivery fittings, valves, regulators & digital flow controllers  
Industrial mass flow meters/controllers  
Process control double block & bleeds  
Process control fittings, valves, regulators & manifold valves  
Permanent no-weld tube fittings  
Precision industrial regulators & flow controllers



## Seal

### Key Markets

Aerospace  
Chemical processing  
Consumer  
Fluid power  
General industrial  
Information technology  
Life sciences  
Microelectronics  
Military  
Oil & gas  
Power generation  
Renewable energy  
Telecommunications  
Transportation

### Key Products

Dynamic seals  
Elastomeric o-rings  
Electro-medical instrument design & assembly  
EMI shielding  
Extruded & precision-cut, fabricated elastomeric seals  
High temperature metal seals  
Homogeneous & inserted elastomeric shapes  
Medical device fabrication & assembly  
Metal & plastic retained composite seals  
Shielded optical windows  
Silicone tubing & extrusions  
Thermal management  
Vibration dampening

Parker Hannifin Corporation  
**Parflex Division**  
1300 North Freedom Street  
Ravenna, Ohio 44266  
Phone 330.296.2871  
Fax 330.296.8433  
[www.parker.com/pfd](http://www.parker.com/pfd)



ENGINEERING YOUR SUCCESS.

CAT 4690/MH/US GL10/11