



Prep-Air® II

Miniature FRL Series

Catalog 0714P/USA



⚠ WARNING

FAILURE OR IMPROPER SELECTION OR IMPROPER USE OF THE PRODUCTS AND/OR SYSTEMS DESCRIBED HEREIN OR RELATED ITEMS CAN CAUSE DEATH, PERSONAL INJURY AND PROPERTY DAMAGE.

This document and other information from Parker Hannifin Corporation, its subsidiaries and authorized distributors provide product and/or system options for further investigation by users having technical expertise. It is important that you analyze all aspects of your application including consequences of any failure, and review the information concerning the product or system in the current product catalog. Due to the variety of operating conditions and applications for these products or systems, the user, through its own analysis and testing, is solely responsible for making the final selection of the products and systems and assuring that all performance, safety and warning requirements of the application are met.

The products described herein, including without limitation, product features, specifications, designs, availability and pricing, are subject to change by Parker Hannifin Corporation and its subsidiaries at any time without notice.

Offer of Sale

The items described in this document are hereby offered for sale by Parker Hannifin Corporation, its subsidiaries or its authorized distributors. This offer and its acceptance are governed by the provisions stated on the separate page of this document entitled "Offer of Sale".

© Copyright 2004, Parker Hannifin Corporation. All Rights Reserved.

Table of Contents

Air Line Filters	
Miniature 14F	2-3
Air Line Coalescing Filters	
Miniature 10F	4-5
Air Line Regulators	
Miniature 14R	6-7
Miniature P3A-R	8-9
Miniature P3A-W	10-11
Economy 15R	12-13
Miniature R45	14-15
Air Line Filter / Regulators	
Miniature 14E	16-17
Air Line Lubricators	
Miniature 04L	18-19
Air Line Combinations	
Miniature 2-Unit 14G	20-21
Miniature 3-Unit 14A	20-21
Mounting Bracket Kits	21
Relief Valves - Diaphragm Type	
P130 and P134 Series	22
Offer of Sale	IBC

**CAUTION:**

Polycarbonate bowls, being transparent and tough, are ideal for use with Filters and Lubricators. They are suitable for use in normal industrial environments, but should not be located in areas where they could be subjected to direct sunlight, an impact blow, nor temperatures outside of the rated range. As with most plastics, some chemicals can cause damage. Polycarbonate bowls should not be exposed to chlorinated hydro-carbons, ketones, esters and certain alcohols. They should not be used in air systems where compressors are lubricated with fire-resistant fluids such as phosphate ester and di-ester types.

Metal bowls are recommended where ambient and/or media conditions are not compatible with polycarbonate bowls. Metal bowls resist the action of most such solvents, but should not be used where strong acids or bases are present or in salt laden atmospheres. Consult the factory for specific recommendations where these conditions exist.

TO CLEAN POLYCARBONATE BOWLS USE MILD SOAP AND WATER ONLY! DO NOT use cleansing agents such as acetone, benzene, carbon tetrachloride, gasoline, toluene, etc., which are damaging to this plastic.

Metal bowl guards are recommended for all applications.

**CAUTION:**

REGULATOR PRESSURE ADJUSTMENT – The working range of knob adjustment is designed to permit outlet pressures within their full range. Pressure adjustment beyond this range is also possible because the knob is not a limiting device. This is a common characteristic of most industrial regulators, and limiting devices may be obtained only by special design.

14F Filters – Miniature

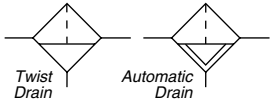

Features

- Excellent water removal efficiency.
- Unique deflector plate that creates swirling of the air stream ensuring maximum water and dirt separation.
- Easily disassembled for servicing without the use of tools.
- Interchangeable twist and automatic pulse drains.
- High Flow: 1/8" – 22 SCFM §
 1/4" – 24 SCFM §

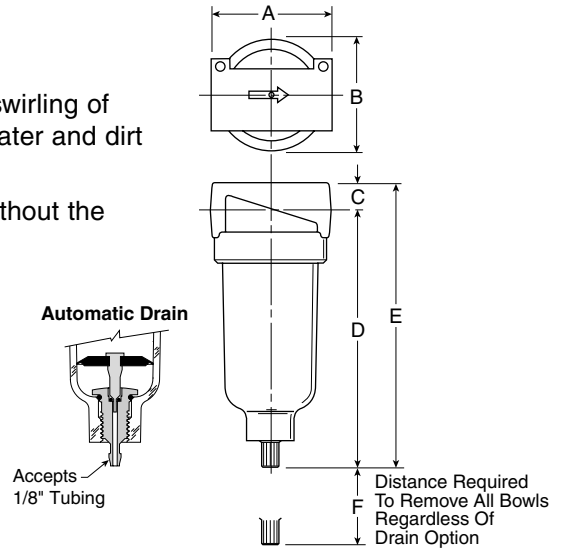

Port Size	NPT	
	Twist Drain	Automatic Pulse Drain
Poly Bowl †		
1/8"	14F01B*	14F05B*
1/4"	14F11B*	14F15B*
Metal Bowl without Sight Gauge		
1/8"	14F03B*	14F07B*
1/4"	14F13B*	14F17B*

14F Filter Dimensions		
A 1.69 (43)	B 1.56 (39.6)	C 0.39 (10)
D 3.82 (97)	D† 3.67 (93)	E 4.21 (107)
E† 4.06 (103)	F 1.60 (41)	

Standard part numbers shown bold. For other models refer to ordering information below.
 † For polycarbonate bowl see Caution on page 1.
 § SCFM = Standard cubic feet per minute at 90 PSIG inlet and 5 PSIG pressure drop.

Inches (mm)
 † With Automatic Pulse Drain

Ordering Information

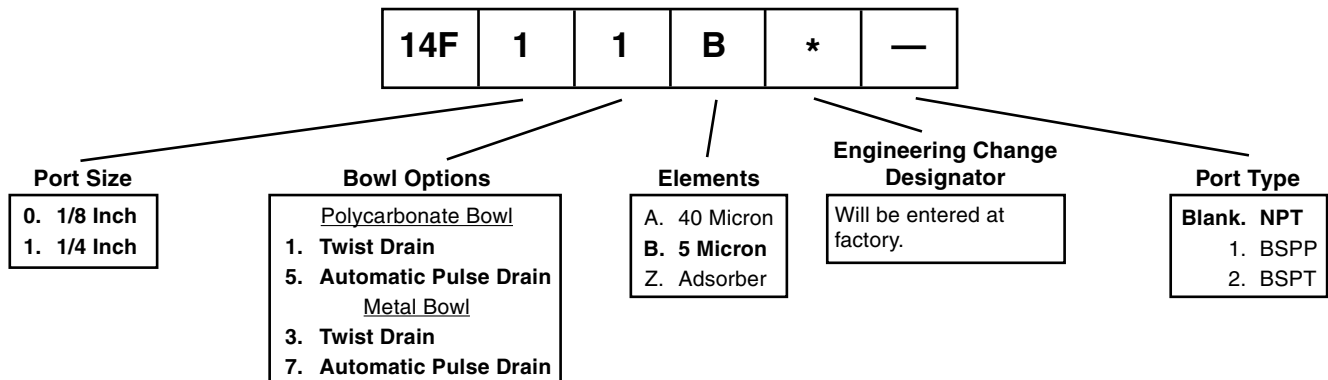

NOTE: BOLD OPTIONS ARE STANDARD.

Technical Information

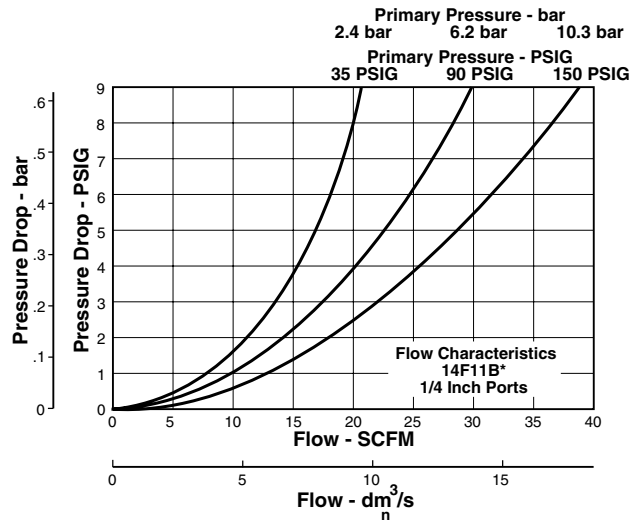
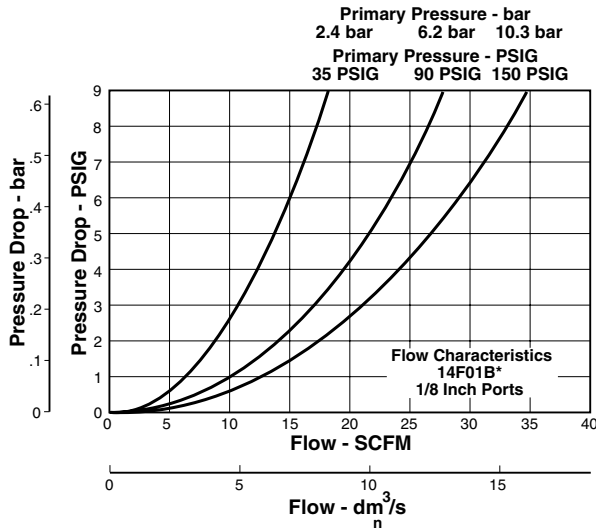

14F Filter Kits & Accessories

Bowl Kits –

- Poly Bowl – Automatic Pulse Drain PS408P
- Twist Drain PS404P
- Metal Bowl – Automatic Pulse Drain PS451P
- Twist Drain PS447BP

Filter Element Kits –

- 40 Micron PS401P
- 5 Micron PS403P
- 5 Micron Cartridge Kit PS407P
- Adsorber PS452P

- Mounting Bracket Kit PS417BP

Specifications

- Automatic Pulse Drain Tube Barb 1/8 Inch
- Bowl Capacity 1 Ounce
- Port Threads 1/8, 1/4 Inch
- Pressure & Temperature Ratings –
 - Polycarbonate Bowl – 0 to 150 PSIG (0 to 10.3 bar)
32°F to 125°F (0°C to 52°C)
 - Metal Bowl – 0 to 250 PSIG (0 to 17.2 bar)
32°F to 175°F (0°C to 80°C)
 - Automatic Pulse Drain – 10 to 250 PSIG (0.7 to 17.2 bar)
at 125°F (52°C) or less
- Weight 0.41 lb. (0.18 kg)

Materials of Construction

- Body Zinc
- Bowls Transparent Polycarbonate
Metal (Zinc) Bowl w/o Sight Gauge
- Deflector, Element Holder & Baffle Plastic
- Drains – Twist Drain –
 - Body & Stem Plastic
 - Seals Nitrile
- Automatic Pulse Drain –
 - Piston & Seals Nitrile
 - Stem, Seat, Adaptor & Washers Aluminum
- Filter Elements –5 Micron (Standard) Plastic
40 Micron (Optional) Plastic
Adsorber (Optional) Activated Charcoal
- Seals Nitrile

Technical Information

Grade 6

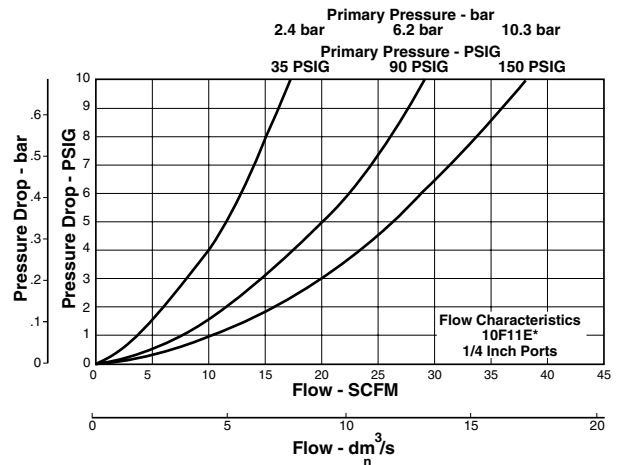
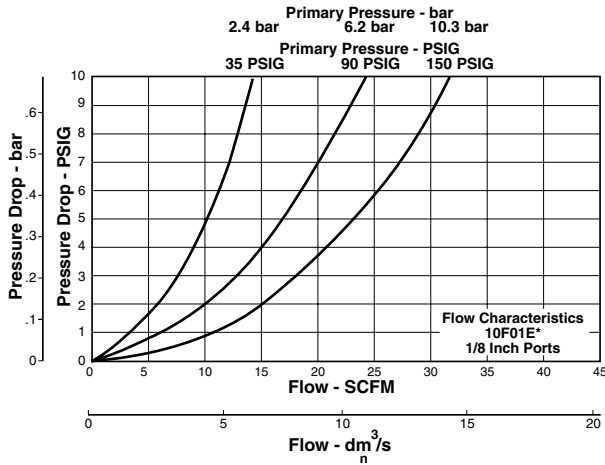

Grade 10

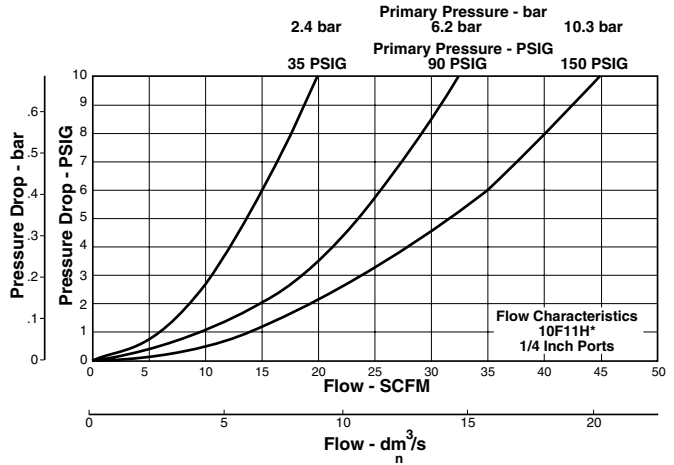
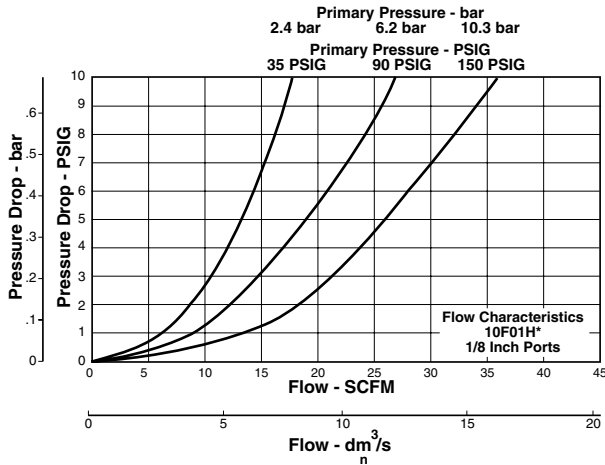

10F Coalescing Filter Kits & Accessories

Bowl Kits –

- Poly Bowl – Automatic Pulse Drain PS408P
- Twist Drain PS404P
- Metal Bowl – Automatic Pulse Drain PS451P
- Twist Drain PS447BP

- Filter Element Kits – Grade 6 (Standard) PS446P
- Grade 10 (Optional) PS456P

- Mounting Bracket Kit PS417BP

Specifications

- Automatic Pulse Drain Tube Barb 1/8 Inch
- Bowl Capacity 1 Ounce
- Operation –
 - Normal Operating Pressure Drop 2 PSIG
 - Maximum Recommended Pressure Drop 10 PSIG (Element should be replaced)
- Port Threads 1/8, 1/4 Inch
- Pressure & Temperature Ratings –
 - Polycarbonate Bowl – 0 to 150 PSIG (0 to 10.3 bar)
 - 32°F to 125°F (0°C to 52°C)
 - Metal Bowl – 0 to 250 PSIG (0 to 17.2 bar)
 - 32°F to 175°F (0°C to 80°C)
- Weight 0.41 lb. (0.18 kg)

Media Specifications

Grade	D.O.P. Coalescing Efficiency 0.3 to 0.6 Micron Particles	Maximum Oil Carryover ¹ PPM w/w	Pressure Drop (PSID) ² @ Rated Flow		Particulate Micron Rating
			Media Dry	Media Wet With 10-20 wt. oil	
6	99.97%	0.008	1.0	2-3	0.01
10	95%	0.85	0.5	0.5	0.7

¹ Tested per BCAS 860900 at 40 ppm inlet.
² Add dry + wet for total pressure drop.

D.O.P. = Dioctylphthalate

Materials of Construction

- Body Zinc
- Bowls Transparent Polycarbonate
- Metal (Zinc) Without Sight Gauge
- Drains – Twist Drain –
 - Body & Stem Plastic
 - Seals Nitrile
- Automatic Pulse Drain –
 - Piston & Seals Nitrile
 - Stem, Seat, Adaptor & Washers Aluminum
- Element Holder Plastic
- Filter Elements Borosilicate & Felt Glass Fibers
- Seals Nitrile

14R Regulators – Miniature

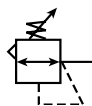

Features

- Unbalanced poppet standard.
- Solid control piston with lip seal for extended life.
- Non-rising adjusting knob.
- Compact, 2.88 inch (73.2mm) high by 1.65 inch (42mm) wide.
- Easily serviced.
- High Flow: 1/8" – 13 SCFM §
 1/4" – 15 SCFM §

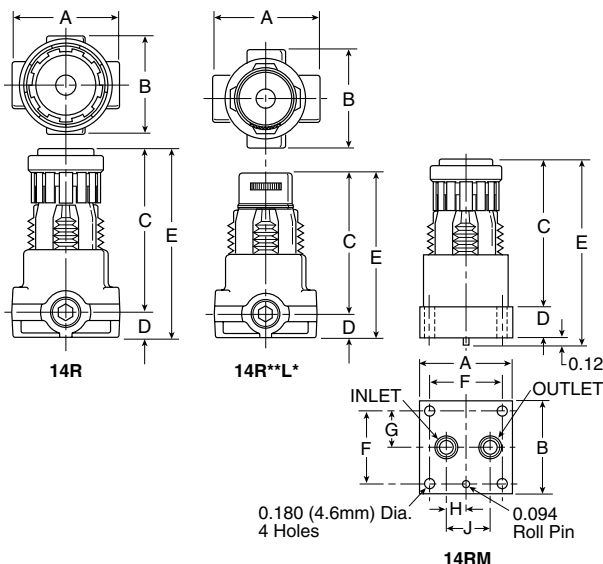

Port Size	NPT
Without Gauge	
1/8"	14R013F*
1/4"	14R113F*
With Gauge	
1/8"	14R018F*
1/4"	14R118F*

14R Regulator Dimensions					
14R	A	B	C	D	E
	1.65 (42)	1.56 (40)	2.50 (63.5)	0.38 (10)	2.88 (73)
14R**L*	A	B	C	D	E
	1.65 (42)	1.56 (40)	2.28 (57.9)	0.38 (10)	2.68 (68)
14RM	A	B	C	D	E
	1.50 (38)	1.50 (38)	2.36 (60)	0.50 (13)	2.98 (73)
	F	G	H	J	
	1.188 (30)	0.594 (15)	0.325 (8)	0.725 (18)	

Standard part numbers shown bold. For other models refer to ordering information below.

NOTE: 1.218 Dia. (31mm) hole required for panel mounting.

§ SCFM = Standard cubic feet per minute at 100 PSIG inlet, 90 PSIG no flow secondary setting and 10 PSIG pressure drop.

Inches (mm)

Ordering Information

NOTE: BOLD OPTIONS ARE STANDARD.

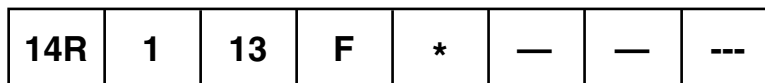

Port Size	Pressure Range	Relief	Port Type	Options	Preset / Pressure Limited
0. 1/8 Inch Pipe, 1/8 Inch Gauge Port 1. 1/4 Inch Pipe, 1/8 Inch Gauge Port B. 1/4 Inch Pipe, 1/4 Inch Gauge Port C. 1/8 Inch Pipe, No Gauge Port D. 1/4 Inch Pipe, No Gauge Port M. Manifold Mounting	<u>Without Gauge</u> Yellow Knob Black Knob 10. 30 PSIG B0. 30 PSIG 11. 60 PSIG B1. 60 PSIG 12. 15 PSIG B2. 15 PSIG 13. 125 PSIG B3. 125 PSIG <u>With Gauge</u> 15. 30 PSIG B5. 30 PSIG 16. 60 PSIG B6. 60 PSIG 17. 15 PSIG B7. 15 PSIG 18. 125 PSIG B8. 125 PSIG	F. Relieving G. Non-Relieving	Blank. NPT 1. BSPP 2. BSPT	Blank. No Options L. † Preset Non-Adjustable P. † Preset Adjustable S. † Pressure Limiter Max. Adjustable T. † Pressure Limiter Max. Non-Adjustable	Blank. None XXX* Preset Pressure XXX* Pressure Limited * Available Preset / Pressure Limited Range, 10 to 90 PSIG in 5 PSIG increments. For higher pressures, contact factory. (Example: 065 = 65 PSIG)

Engineering Change Designator
 Will be entered at factory.

Spring Type by Preset / Limited Pressure:
 For Preset / Limited Pressure 10 to 25 use 30 PSI Spring
 For Preset / Limited Pressure 26 to 50 use 60 PSI Spring
 For Preset / Limited Pressure 51 to 90 use 125 PSI Spring

† Inlet Pressure is 100 PSIG. For other pressures, contact factory.

P3A-R Regulators – Miniature

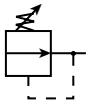

Features

- Lightweight plastic body.
- Non-rising adjusting knob.
- Solid control piston with lip seal for extended life.
- Unbalanced poppet standard.
- Two full flow 1/8" gauge ports.
- Reverse flow capability.
- High Flow: 1/8" – 18 SCFM[§]

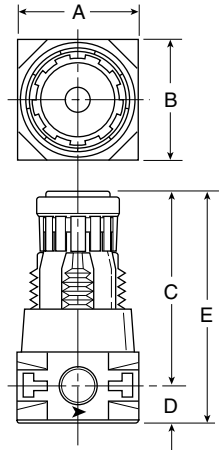

Port Size	NPT
Without Gauge	
1/8"	P3A-RN91YNN
1/4"	P3A-RN92YNN
With Gauge	
1/8"	P3A-RN91YGN
1/4"	P3A-RN92YGN

P3A-R Regulator Dimensions			
A	B	C	D
1.57 (40)	1.57 (40)	2.46 (63)	0.46 (12)
E			
2.92 (74)			

Inches (mm)

Standard part numbers shown bold. For other models refer to ordering information below.

NOTE: 1.218 Dia. (31mm) hole required for panel mounting.
[§] SCFM = Standard cubic feet per minute at 100 PSIG inlet, 90 PSIG no flow secondary setting and 10 PSIG pressure drop.

⚠ WARNING

**Product rupture can cause serious injury.
 Do not connect regulator to bottled gas.
 Do not exceed maximum primary pressure rating.**

Ordering Information

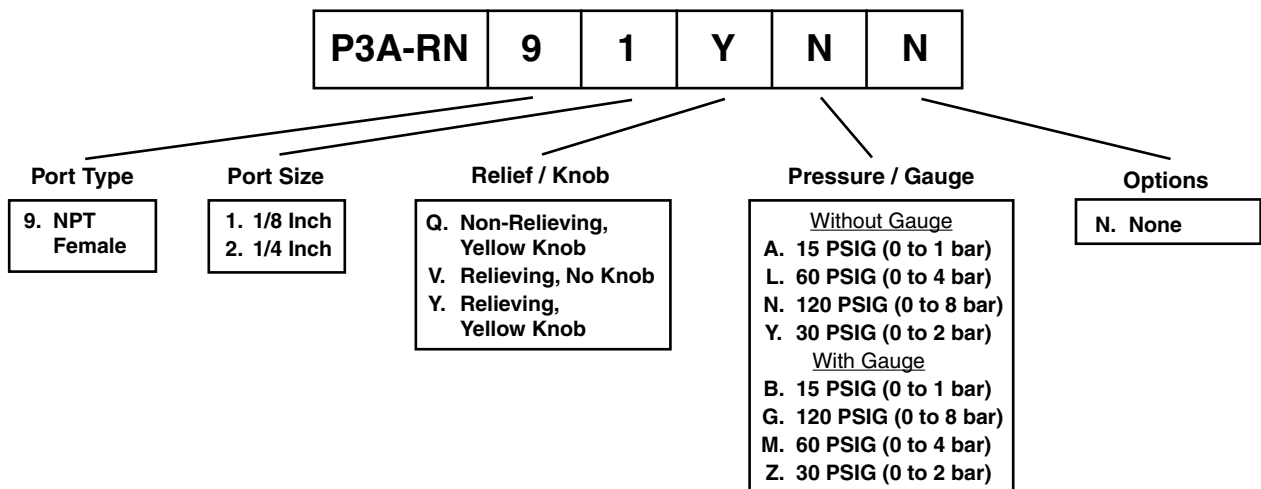

NOTE: BOLD OPTIONS ARE STANDARD.

Technical Information

Relief And Flow Characteristics
P3A-RN91YNN

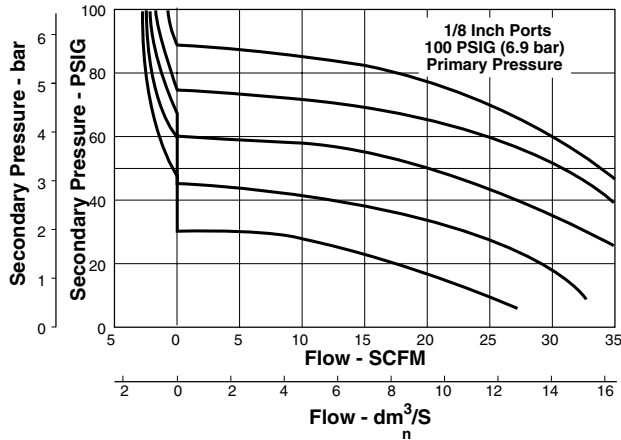

Relief And Flow Characteristics
P3A-RN92YNN

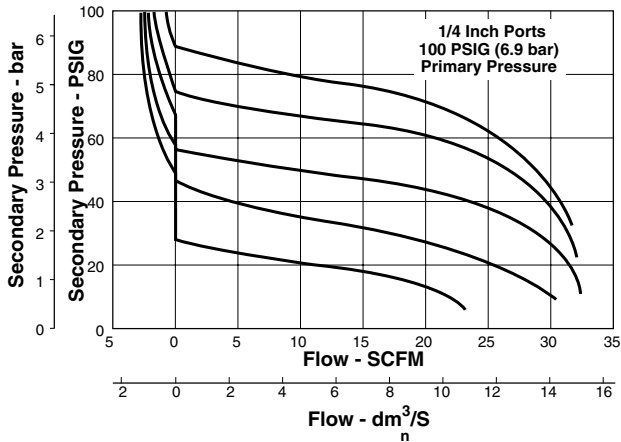

Regulator Kits and Accessories

- Gauges – 30 PSIG, 1/8" NPT (0 to 2.1 bar) P530156
- 60 PSIG, 1/8" NPT (0 to 4.1 bar) P530154
- 160 PSIG, 1/8" NPT (0 to 11.0 bar) P77413
- Panel Mount Nut P78652
- Mounting Bracket Kit PS417BP
- Service Kits – Piston Non-Relieving PS422
- Piston Relieving PS423
- Poppet Service Kits – Balanced PS425B
- Unbalanced PS424B
- Springs – 1-15 PSIG Spring (Yellow) P01176
- 1-30 PSIG Spring (Black) P01175
- 1-60 PSIG Spring (White) P01174
- 5-110 PSIG Spring (Gold) P01173

Specifications

- Gauge Ports (2) 1/8 Inch
- Operating Pressure Range –

Primary –	Maximum	PSIG	bar
		120	8.3
Secondary –			
15 PSIG Spring	Minimum	1	0.07
	Maximum	15	1.0
30 PSIG Spring	Minimum	6	0.4
	Maximum	30	2.1
60 PSIG Spring	Minimum	6	0.4
	Maximum	60	4.1
110 PSIG Spring	Minimum	6	0.4
	Maximum	110	7.6
- Operating Temperature Range 32°F to 125°F (0°C to 52°C)
- Port Threads 1/8, 1/4 Inch
- Weight 0.23 lb. (0.10 kg)

Materials of Construction

- Adjusting Nut Brass
- Adjusting Stem and Spring Steel
- Poppet Return Spring Stainless Steel
- Body Plastic
- Bonnet, Seat and Piston Plastic
- Seals Nitrile
- Valve Poppet Plastic & Nitrile

P3A-W Regulators – Miniature (Water Service)

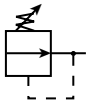

Features

- Lightweight plastic body.
- Constructed of F.D.A. listed materials.
- Unbalanced poppet standard.
- Non-rising adjusting knob.
- Compact, 2.96 inch (75mm) high by 1.57 inch (40mm) wide.
- Lightweight.
- Rolling diaphragm for superior performance and life.

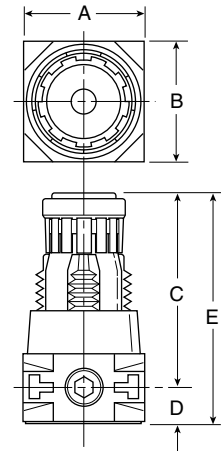

Port Size	NPT
Without Gauge	
1/8"	P3A-WN91QNN
1/4"	P3A-WN92QNN

Standard part numbers shown bold. For other models refer to ordering information below.

NOTE: 1.218 Dia. (31mm) hole required for panel mounting.

P3A-W Regulator Dimensions			
A	B	C	D
1.57 (40)	1.57 (40)	2.50 (64)	0.46 (12)
E			
2.96 (75)			

Inches (mm)

⚠ WARNING
<p>Product rupture can cause serious injury. Do not connect regulator to bottled gas. Do not exceed maximum primary pressure rating.</p>

Ordering Information

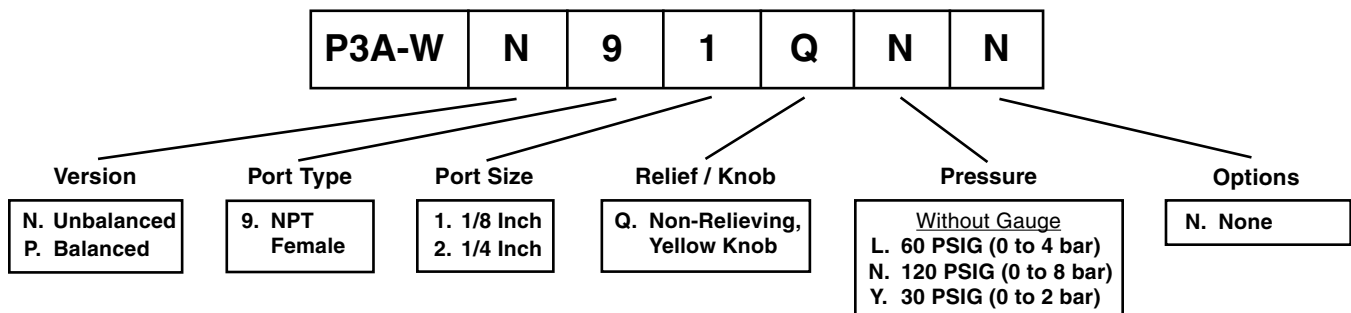

NOTE: BOLD OPTIONS ARE STANDARD.

Technical Information

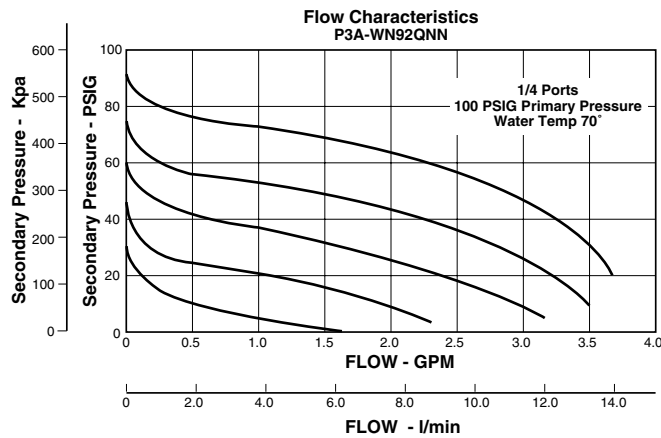
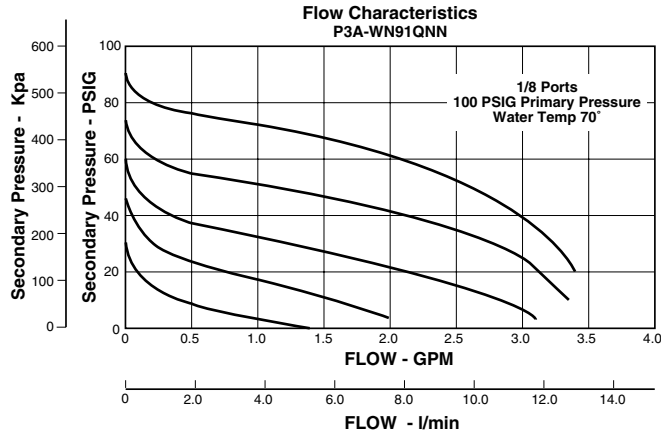

Regulator Kits and Accessories

- Panel Mount Nut P78652
- Mounting Bracket Kit PS417BP
- Service Kits – Piston Non-Relieving PS422
- Poppet Service Kits – Balanced PS425B
- Unbalanced PS424B
- Springs – 1-30 PSIG Spring P78659B
- 1-60 PSIG Spring P00411
- 5-125 PSIG Spring P78660B

Specifications

- Gauge Ports (2) 1/8 Inch
(Can be used for full flow)
- Pressure Rating –
Maximum Inlet Pressure 150 PSIG (10.0 bar)
- Port Threads 1/8, 1/4 Inch
- Temperature Rating Water 40°F to 125°F (4°C to 52°C)
- Weight 0.23 lb. (0.10 kg)

Materials of Construction

- Adjusting Nut Brass
- Adjusting Stem Brass
- Body Plastic
- Bonnet, Seat and Piston Plastic
- Diaphragm Santoprene
- Seals Buna N or Thermo Plastic Elastomer
- Springs Stainless Steel
- Valve Poppet Plastic / Nitrile

15R Regulators – Economy

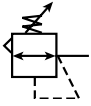

Features

- Unique balanced poppet valve minimizes secondary pressure fluctuations.
- Solid control piston with resilient seat for service-free operation.
- Non-rising “locking” adjusting knob.
- Compact, 3.30 inch (84mm) high by 2.12 inch (54mm) wide.
- Easily serviced.

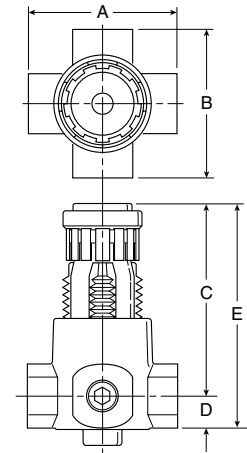

Port Size	NPT
Without Gauge	
1/4"	15R113F*
3/8"	15R213F*
With Gauge	
1/4"	15R118F*
3/8"	15R218F*

15R Regulator Dimensions			
A	B	C	D
2.12 (54)	2.00 (51)	2.60 (66)	0.70 (18)
E			
3.30 (84)			

Inches (mm)

Standard part numbers shown bold. For other models refer to ordering information below.

NOTE: 1.218 Dia. (31mm) hole required for panel mounting.

§ SCFM = Standard cubic feet per minute at 100 PSIG inlet, 90 PSIG no flow secondary setting and 10 PSIG pressure drop.

WARNING

**Product rupture can cause serious injury.
 Do not connect regulator to bottled gas.
 Do not exceed maximum primary pressure rating.**

Ordering Information

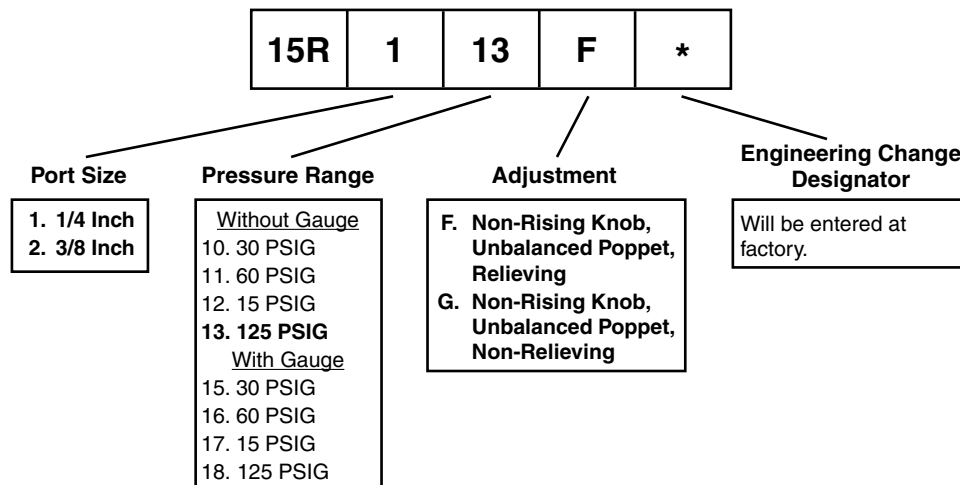

NOTE: BOLD OPTIONS ARE STANDARD.

Technical Information

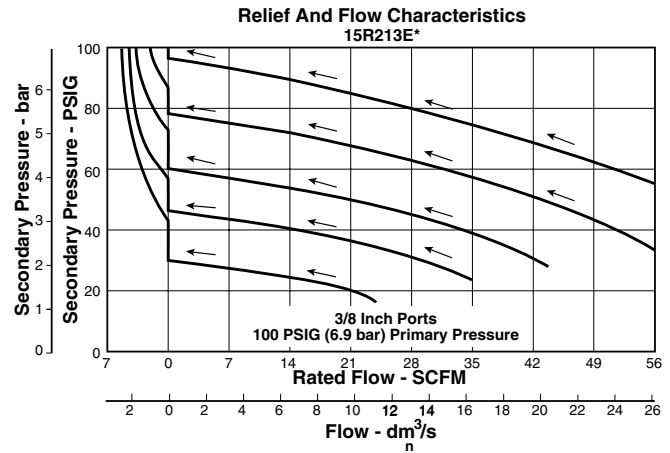
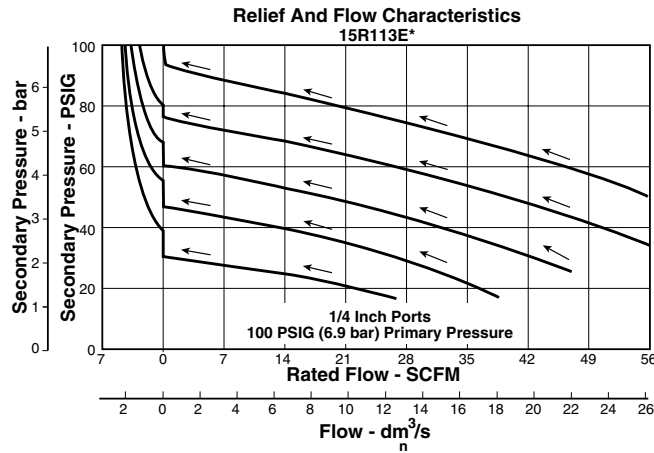

CAUTION:

REGULATOR PRESSURE ADJUSTMENT – The working range of knob adjustment is designed to permit outlet pressures within their full range. Pressure adjustment beyond this range is also possible because the knob is not a limiting device. This is a common characteristic of most industrial regulators, and limiting devices may be obtained only by special design.

15R Regulator Kits & Accessories

- Body Service Kit – Unbalanced PS424BP
- Bonnet Assembly Kit L01369
- Gauges – 30 PSIG, 1/8" NPT (0 to 2.1 bar) P530156
- 60 PSIG, 1/8" NPT (0 to 4.1 bar) P530154
- 160 PSIG, 1/8" NPT (0 to 11.0 bar) P77413
- 60 PSIG, 1/4" NPT (0 to 4.1 bar) P781641
- 160 PSIG, 1/4" NPT (0 to 11.0 bar) P781642
- Mounting Bracket Kit (Includes Panel Mount Nut) PS417BP
- Panel Mount Nuts –Plastic P78652
- Metal P01531
- Service Kits – Non-Relieving PS422P
- Relieving PS423P
- Springs – 1-15 PSIG Range (Yellow) P01176
- 1-30 PSIG Range (Black) P01175
- 1-60 PSIG Range (White) P01174
- 2-125 PSIG Range (Gold) P01173

Specifications

- Gauge Ports (2) 1/4 Inch
(Can be used for Full Flow)
- Port Threads 1/4, 3/8 Inch
- Pressure & Temperature Ratings – 0 to 250 PSIG (0 to 17.2 bar)
32°F to 125°F (0°C to 52°C)
- Secondary Pressure Ranges –
 - Standard Pressure 2 to 125 PSIG (0 to 8.6 bar)
 - Medium Pressure 1 to 60 PSIG (0 to 4.1 bar)
 - Medium Pressure 1 to 30 PSIG (0 to 2.1 bar)
 - Low Pressure 1 to 15 PSIG (0 to 1 bar)
- Weight 0.5 lb. (0.23 kg)

Materials of Construction

- Adjusting Nut Brass
- Adjusting Stem & Spring Steel
- Body Zinc
- Bonnet, Seat, Piston & Valve Poppet Plastic
- Seals Nitrile

Technical Information

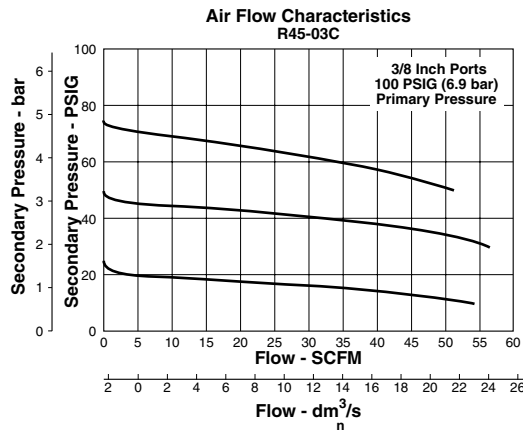
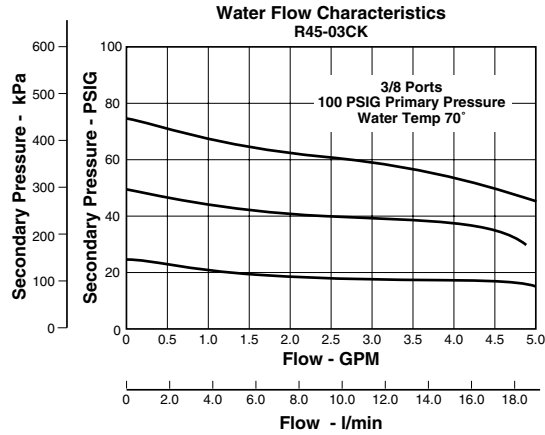

Regulator Kits and Accessories

- Panel Mount Nut –
 - Plastic R05X51
 - Aluminum R05X51A
- Mounting Bracket and Nut SA161X57
- Service Kits –
 - Relieving RKR45Y
 - Non-Relieving RKR45KY
- Springs –
 - 0-25 PSIG Spring SPR-46
 - 0-60 PSIG Spring SPR-47
 - 0-125 PSIG Spring SPR-48

Specifications

- Gauge Ports (2) 1/4 Inch
(Can be used for full flow)
- Pressure Rating –
Maximum Inlet Pressure 150 PSIG (10.0 bar)
- Port Threads 1/4, 3/8 Inch
- Temperature Rating 40°F to 125°F (4°C to 52°C)
- Weight 0.38 lb. (0.17 kg)

Materials of Construction

- Adjusting Screw Steel
- Body Acetal
- Bonnet and Seat Acetal
- Diaphragm Buna N
- Seals Buna N
- Springs Stainless Steel
- Valve Poppet Buna N

Technical Information

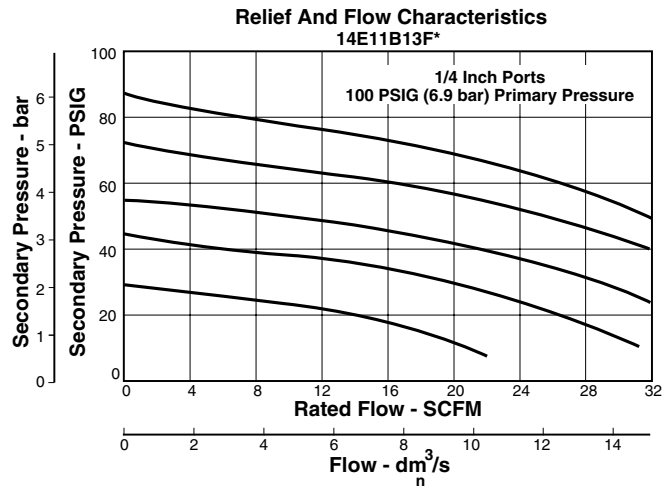
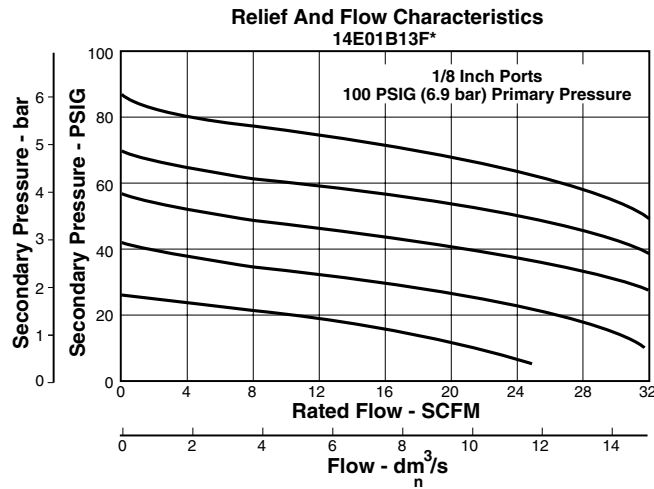

CAUTION:

REGULATOR PRESSURE ADJUSTMENT – The working range of knob adjustment is designed to permit outlet pressures within their full range. Pressure adjustment beyond this range is also possible because the knob is not a limiting device. This is a common characteristic of most industrial regulators, and limiting devices may be obtained only by special design.

For best performance, regulated pressure should always be set by increasing the pressure up to the desired setting.

⚠ WARNING

**Product rupture can cause serious injury.
Do not connect regulator to bottled gas.
Do not exceed maximum primary pressure rating.**

14E Filter / Regulator Kits & Accessories

Bowl Kits –

- Poly Bowl – Automatic Drain PS408P
- Twist Drain PS404P
- Metal Bowl – Automatic Drain PS451P
- Twist Drain PS447BP

- Filter Element Kits –** 40 Micron PS401P
 5 Micron PS403P
 Adsorber PS452P

- Gauges –** 30 PSIG (0 to 2.1 bar) P530156
 60 PSIG (0 to 4.1 bar) P530154
 160 PSIG (0 to 11.0 bar) P77413

- Mounting Bracket Kit** (Includes Panel Mount Nut) PS417BP

- Panel Mount Nut** P78652

- Poppet Kits –** Unbalanced PS424BP
 Balanced PS425BP

- Service Kits –** Non-Relieving PS422P
 Relieving PS423P

- Springs –** 1- 15 PSIG Range (Yellow) P01176
 1- 30 PSIG Range (Black) P01175
 1- 60 PSIG Range (White) P01174
 2- 125 PSIG Range (Gold) P01173

Specifications

- Automatic Pulse Drain Tube Barb** 1/8 Inch
- Bowl Capacity** 1 Ounce
- Gauge Ports (2)** (Can be used for Full Flow) 1/8 Inch
- Port Threads** 1/8, 1/4 Inch

Pressure & Temperature Ratings –

- Polycarbonate Bowl
 0 to 150 PSIG (0 to 10.3 bar), 32°F to 125°F (0°C to 52°C)
- Metal Bowl
 0 to 250 PSIG (0 to 17.2 bar), 32°F to 175°F (0°C to 80°C)

Secondary Pressure Ranges –

- Standard Pressure 2 to 125 PSIG (0 to 8.6 bar)
- Medium Pressure 1 to 30 PSIG (0 to 2.1 bar)
- Medium Pressure 1 to 60 PSIG (0 to 4.1 bar)
- Low Pressure 1 to 15 PSIG (0 to 1 bar)

Weight 0.4 lb. (0.18 kg)

Materials of Construction

- Adjusting Nut** Brass
- Adjusting Stem & Spring** Steel
- Body** Zinc
- Bonnet, Knob, Seat, Piston, Holder & Deflector** Plastic
- Bowls Available –** Transparent Polycarbonate
 Metal (Without Sight Gauge) Zinc
- Drains – Manual – Twist Type**
 Body & Stem Plastic
 Seals Nitrile
- Automatic – Pulse Type
 Piston & Seals Nitrile
 Stem, Seat, Adaptor & Washers Aluminum
- Filter Elements –** 5 Micron (Standard) Plastic
 40 Micron (Optional) Plastic
 Adsorber (Optional) Activated Charcoal
- Seals** Nitrile

Technical Information

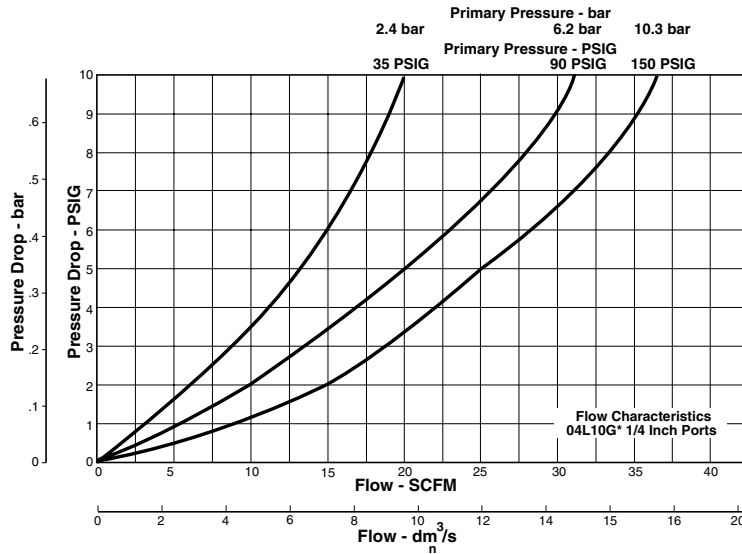
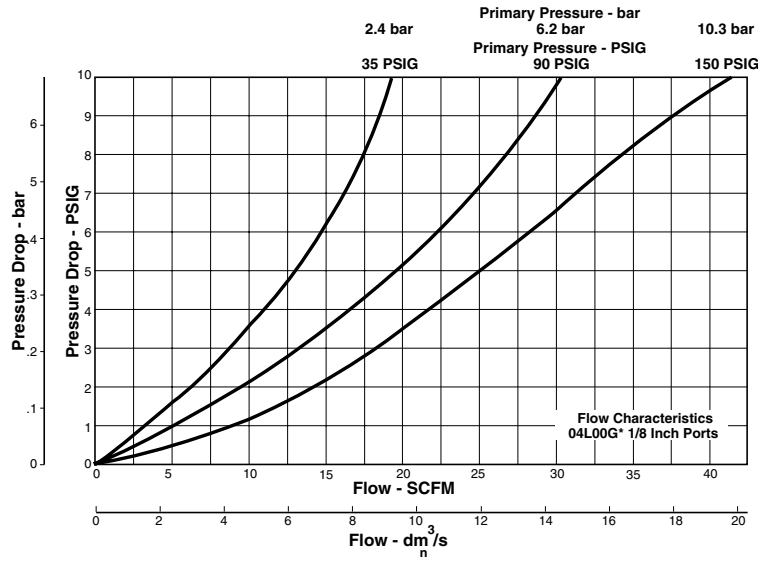

04L Mist Lubricator Kits & Accessories

Bowl Kits –

- Poly Bowl – No Drain PS421P
- Twist Drain PS420P
- Metal Bowl – Twist Drain (No Sight Gauge) PS447BP

Mounting Bracket Kit PS419

- Oil – 1 Gal. F442002
- 12 Quart Case F442003
- 4 Gallon Case F442005

Specifications

- Bowl Capacity 1 Ounce
- Minimum Flow for Lubrication 0.5 SCFM at 100 PSIG
- Port Threads 1/8, 1/4 Inch
- Pressure & Temperature Ratings –
 - Polycarbonate Bowl – 0 to 150 PSIG (0 to 10.3 bar)
32°F to 125°F (0°C to 52°C)
 - Metal Bowl – 0 to 250 PSIG (0 to 17.2 bar)
32°F to 175°F (0°C to 80°C)

Suggested Lubricant – F442 Oil

Petroleum based oil of 100 to 200 SSU viscosity at 100°F and an aniline point greater than 200°F (DO NOT USE OILS WITH ADDITIVES, COMPOUNDED OILS CONTAINING SOLVENTS, GRAPHITE, DETERGENTS, OR SYNTHETIC OILS.)

Weight 0.4 lb. (0.18 kg)

Materials of Construction

- Body Zinc
- Bowls – Transparent Polycarbonate
- Metal (Without Sight Gauge) Zinc
- Drains – Twist – Body & Nut Plastic
- Seals Nitrile
- Sight Dome Polycarbonate

Close Nipped Combinations – 14 Miniature Series

Ordering Information

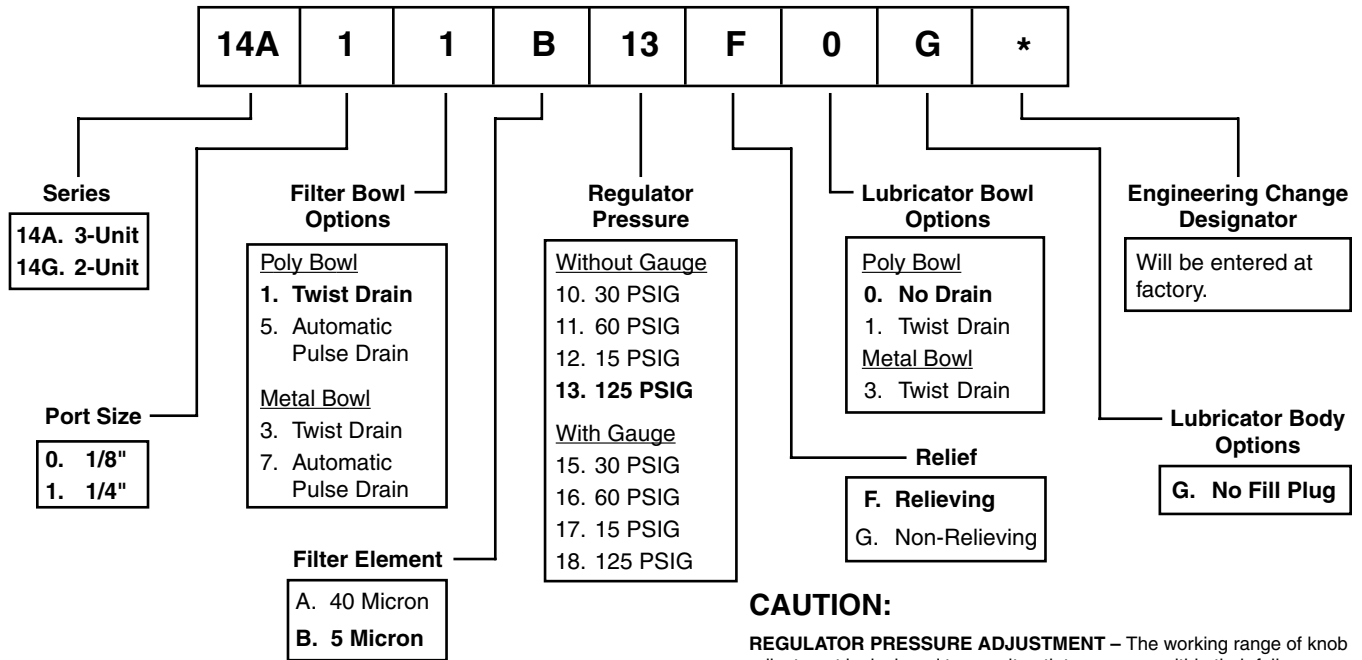

CAUTION:

REGULATOR PRESSURE ADJUSTMENT – The working range of knob adjustment is designed to permit outlet pressures within their full range. Pressure adjustment beyond this range is also possible because the knob is not a limiting device. This is a common characteristic of most industrial regulators, and limiting devices may be obtained only by special design.

NOTE: BOLD OPTIONS ARE STANDARD.

Mounting Bracket Kits

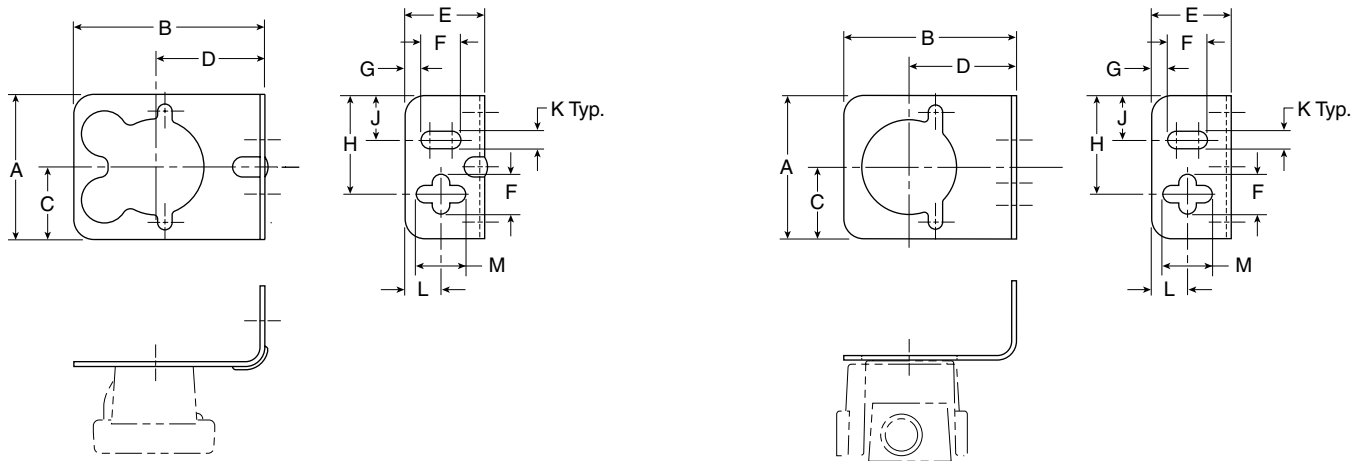

PS417BP
 (Includes Panel Mount Nut)

PS419

Dimensions

	A	B	C	D	E	F	G	H	J	K	L	M	Kit
inches	1.80	2.37	0.90	1.35	1.00	0.50	0.20	1.24	0.56	0.22	0.45	0.62	PS417BP (14F, 10F, 14R, 14E)
mm	46	60	23	34	25	13	5	31	14	6	11	16	
inches	1.80	2.17	0.90	1.35	1.00	0.50	0.20	1.24	0.56	0.22	0.45	0.62	PS419 (04L)
mm	46	55	23	34	25	13	5	31	14	6	11	16	

Offer of Sale

The items described in this document and other documents or descriptions provided by Parker Hannifin Corporation, its subsidiaries and its authorized distributors, are hereby offered for sale at prices to be established by Parker Hannifin Corporation, its subsidiaries and its authorized distributors. This offer and its acceptance by any customer ("Buyer") shall be governed by all of the following Terms and Conditions. Buyer's order for any such item, when communicated to Parker Hannifin Corporation, its subsidiaries or an authorized distributor ("Seller") verbally or in writing, shall constitute acceptance of this offer.

1. Terms and Conditions of Sale: All descriptions, quotations, proposals, offers, acknowledgments, acceptances and sales of Seller's products are subject to and shall be governed exclusively by the terms and conditions stated herein. Buyer's acceptance of any offer to sell is limited to these terms and conditions. Any terms or conditions in addition to, or inconsistent with those stated herein, proposed by Buyer in any acceptance of an offer by Seller, are hereby objected to. No such additional, different or inconsistent terms and conditions shall become part of the contract between Buyer and Seller unless expressly accepted in writing by Seller. Seller's acceptance of any offer to purchase by Buyer is expressly conditional upon Buyer's assent to all the terms and conditions stated herein, including any terms in addition to, or inconsistent with those contained in Buyer's offer. Acceptance of Seller's products shall in all events constitute such assent.

2. Payment: Payment shall be made by Buyer net 30 days from the date of delivery of the items purchased hereunder. Amounts not timely paid shall bear interest at the maximum rate permitted by law for each month or portion thereof that the Buyer is late in making payment. Any claims by Buyer for omissions or shortages in a shipment shall be waived unless Seller receives notice thereof within 30 days after Buyer's receipt of the shipment.

3. Delivery: Unless otherwise provided on the face hereof, delivery shall be made F.O.B. Seller's plant. Regardless of the method of delivery, however, risk of loss shall pass to Buyer upon Seller's delivery to a carrier. Any delivery dates shown are approximate only and Seller shall have no liability for any delays in delivery.

4. Warranty: Seller warrants that the items sold hereunder shall be free from defects in material or workmanship for a period of 18 months from date of shipment from Parker Hannifin Corporation. THIS WARRANTY COMPRISES THE SOLE AND ENTIRE WARRANTY PERTAINING TO ITEMS PROVIDED HEREUNDER. SELLER MAKES NO OTHER WARRANTY, GUARANTEE, OR REPRESENTATION OF ANY KIND WHATSOEVER. ALL OTHER WARRANTIES, INCLUDING BUT NOT LIMITED TO, MERCHANTABILITY AND FITNESS FOR PURPOSE, WHETHER EXPRESS, IMPLIED, OR ARISING BY OPERATION OF LAW, TRADE USAGE, OR COURSE OF DEALING ARE HEREBY DISCLAIMED. NOTWITHSTANDING THE FOREGOING, THERE ARE NO WARRANTIES WHATSOEVER ON ITEMS BUILT OR ACQUIRED WHOLLY OR PARTIALLY, TO BUYER'S DESIGN OR SPECIFICATIONS.

5. Limitation of Remedy: SELLER'S LIABILITY ARISING FROM OR IN ANY WAY CONNECTED WITH THE ITEMS SOLD OR THIS CONTRACT SHALL BE LIMITED EXCLUSIVELY TO REPAIR OR REPLACEMENT OF THE ITEMS SOLD OR REFUND OF THE PURCHASE PRICE PAID BY BUYER, AT SELLER'S SOLE OPTION. IN NO EVENT SHALL SELLER BE LIABLE FOR ANY INCIDENTAL, CONSEQUENTIAL OR SPECIAL DAMAGES OF ANY KIND OR NATURE WHATSOEVER, INCLUDING BUT NOT LIMITED TO LOST PROFITS ARISING FROM OR IN ANY WAY CONNECTED WITH THIS AGREEMENT OR ITEMS SOLD HEREUNDER, WHETHER ALLEGED TO ARISE FROM BREACH OF CONTRACT, EXPRESS OR IMPLIED WARRANTY, OR IN TORT, INCLUDING WITHOUT LIMITATION, NEGLIGENCE, FAILURE TO WARN OR STRICT LIABILITY.

6. Changes, Reschedules and Cancellations: Buyer may request to modify the designs or specifications for the items sold hereunder as well as the quantities and delivery dates thereof, or may request to cancel all or part of this order, however, no such requested modification or cancellation shall become part of the contract between Buyer and Seller unless accepted by Seller in a written amendment to this Agreement. Acceptance of any such requested modification or cancellation shall be at Seller's discretion, and shall be upon such terms and conditions as Seller may require.

7. Special Tooling: A tooling charge may be imposed for any special tooling, including without limitations, dies, fixtures, molds and patterns, acquired to manufacture items sold pursuant to this contract. Such special tooling shall be and remain Seller's property notwithstanding payment of any charges by Buyer. In no event will Buyer acquire any interest in apparatus belonging to Seller which is utilized in the manufacture of the items sold hereunder, even if such apparatus has been specially converted or adapted for such manufacture and notwithstanding any charges paid by Buyer. Unless otherwise agreed,

Seller shall have the right to alter, discard or otherwise dispose of any special tooling or other property in its sole discretion at any time.

8. Buyer's Property: Any designs, tools, patterns, materials, drawings, confidential information or equipment furnished by Buyer, or any other items which become Buyer's property, may be considered obsolete and may be destroyed by Seller after two (2) consecutive years have elapsed without Buyer placing an order for the items which are manufactured using such property. Seller shall not be responsible for any loss or damage to such property while it is in Seller's possession or control.

9. Taxes: Unless otherwise indicated on the face hereof, all prices and charges are exclusive of excise, sales, use, property, occupational or like taxes which may be imposed by any taxing authority upon the manufacture, sale or delivery of the items sold hereunder. If any such taxes must be paid by Seller or if Seller is liable for the collection of such tax, the amount thereof shall be in addition to the amounts for the items sold. Buyer agrees to pay all such taxes or to reimburse Seller therefore upon receipt of its invoice. If Buyer claims exemption from any sales, use or other tax imposed by any taxing authority, Buyer shall save Seller harmless from and against any such tax, together with any interest or penalties thereon which may be assessed if the items are held to be taxable.

10. Indemnity For Infringement of Intellectual Property Rights: Seller shall have no liability for infringement of any patents, trademarks, copyrights, trade dress, trade secrets or similar rights except as provided in this Part 10. Seller will defend and indemnify Buyer against allegations of infringement of U.S. patents, U.S. trademarks, copyrights, trade dress and trade secrets (hereinafter "Intellectual Property Rights"). Seller will defend at its expense and will pay the cost of any settlement or damages awarded in an action brought against Buyer based on an allegation that an item sold pursuant to this contract infringes the Intellectual Property Rights of a third party. Seller's obligation to defend and indemnify Buyer is contingent on Buyer notifying Seller within ten (10) days after Buyer becomes aware of such allegations of infringement, and Seller having sole control over the defense of any allegations or actions including all negotiations for settlement or compromise. If an item sold hereunder is subject to a claim that it infringes the Intellectual Property Rights of a third party, Seller may, at its sole expense and option, procure for Buyer the right to continue using said item, replace or modify said item so as to make it noninfringing, or offer to accept return of said item and return the purchase price less a reasonable allowance for depreciation. Notwithstanding the foregoing, Seller shall have no liability for claims of infringement based on information provided by Buyer, or directed to items delivered hereunder for which the designs are specified in whole or part by Buyer, or infringements resulting from the modification, combination or use in a system of any item sold hereunder. The foregoing provisions of this Part 10 shall constitute Seller's sole and exclusive liability and Buyer's sole and exclusive remedy for infringement of Intellectual Property Rights.

If a claim is based on information provided by Buyer or if the design for an item delivered hereunder is specified in whole or in part by Buyer, Buyer shall defend and indemnify Seller for all costs, expenses or judgements resulting from any claim that such item infringes any patent, trademark, copyright, trade dress, trade secret or any similar right.

11. Force Majeure: Seller does not assume the risk of and shall not be liable for delay or failure to perform any of Seller's obligations by reason of circumstances beyond the reasonable control of Seller (hereinafter "Events of Force Majeure"). Events of Force Majeure shall include without limitation, accidents, acts of God, strikes or labor disputes, acts, laws, rules or regulations of any government or government agency, fires, floods, delays or failures in delivery of carriers or suppliers, shortages of materials and any other cause beyond Seller's control.

12. Entire Agreement/Governing Law: The terms and conditions set forth herein, together with any amendments, modifications and any different terms or conditions expressly accepted by Seller in writing, shall constitute the entire Agreement concerning the items sold, and there are no oral or other representations or agreements which pertain thereto. This Agreement shall be governed in all respects by the law of the State of Ohio. No actions arising out of sale of the items sold hereunder or this Agreement may be brought by either party more than two (2) years after the cause of action accrues.



Parker Hannifin Corporation
Pneumatic Division
8676 E. M89
P.O. Box 901
Richland, MI 49083 USA
Tel: (269) 629-5000
Fax: (269) 629-5385

Customer/Technical Service

Tel: (269) 629-5575
Fax: (269) 629-5385
Web site: www.parker.com/pneumatic
E-mail: PDNMKTG@parker.com