

The D3MW is a solenoid operated directional control valve size NG10 in 3-chamber design. It is direct operated by wet pin solenoids.

The D3MW is designed for mobile and marine applications.

It is based on the D3W series, but offers additional corrosion protection of the valve body, the solenoid coil and the anchor tube as well as the typical solenoid connections for the mobile market such as AMP Junior Timer.

Features:

- High corrosion protection (optional)
- Solenoid connection:
 - Standard (as per EN175301-803)
 - AMP Junior Timer
 - DT04-2P “Deutsch”
- Robust design for rough applications

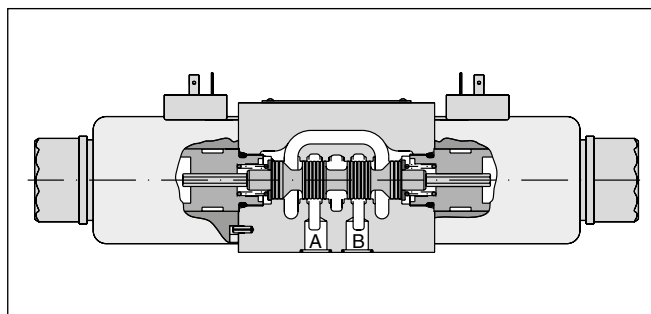
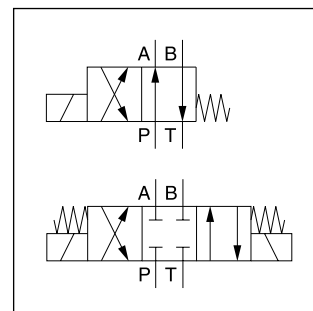

Technical data

General	
Design	Directional spool valve
Actuation	Solenoid
Size	DIN NG10 / CETOP 05 / NFPA D05
Mounting interface	DIN 24340 A10 / ISO 4401 / CETOP RP 121-H / NFPA D05
Mounting position	unrestricted, preferably horizontal
Ambient temperature	[°C] -25...+60
MTTF _D value	[years] 150
Weight	[kg] 4.8 (1 solenoid), 6.3 (2 solenoids)
Vibration resistance	[g] 10 Sinus 5...2000 Hz acc. IEC 68-2-6 30 Random noise 20...2000 Hz acc. IEC 68-2-36 15 Shock acc. IEC 68-2-27
Hydraulic	
Max. operating pressure	[bar] P, A B: 350; T: 210
Fluid	Hydraulic oil according to DIN 51524
Fluid temperature	[°C] -20 ... +70 (NBR: -25...+70)
Viscosity permitted	[cSt] / [mm ² /s] 2.8...400
Viscosity recommended	[cSt] / [mm ² /s] 30...80
Filtration	ISO 4406 (1999); 18/16/13
Flow max.	[l/min] 150 (see shift limits)
Leakage at 50 bar	[ml/min] Up to 20 per flow path, depending on spool
Static / Dynamic	
Step response at 95 %	[ms] Energized: 105 De-energized: 85
Electrical characteristics	
Duty ratio	100 % ED; CAUTION: coil temperature up to 150 °C possible
Max. switching frequency	[1/h] 10000
Protection class	Standard (as per EN175301-803) IP65 in acc. with EN60529 (with correctly mounted plug-in connector) AMP Junior Timer IP67 in acc. with EN60529 (with correctly mounted plug-in connector) DT04-P2 “Deutsch” IP69K (with correctly mounted plug-in connector)
	Code
Supply voltage / ripple	[V] 12 V = 24 V =
Tolerance supply voltage	[%] ±10 ±10
Current consumption	[A] 3 1.5
Power consumption	[W] 36 36
Solenoid connection	Connector as per EN 175301-803 (code W), AMP Junior Timer (code A), DT04-2P “Deutsch” connector (code J). Solenoid ident. as per ISO 9461.
Wiring min.	[mm ²] 3 x 1.5 recommended
Wiring length max.	[m] 50 recommended

With electrical connections the protective conductor (PE ⚡) must be connected according to the relevant regulations.

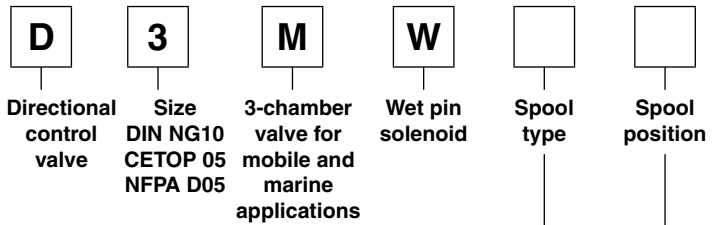

2

3 position spools	
Code	Spool type
	a 0 b
001	
002	
003	
004	
005	
006	
007	
008 ¹⁾	
009 ¹⁾	
010	
011	
012	
014	
015	
016	
021	
022	
031	
032	
081	
082	
102	

2 position spools	
Code	Spool type
	a b
020	
026	
030	
101	

3 position spools		
Code	Spool position	
C		3 positions. Spring offset in position "0". Operated in position "a" or "b".
	Standard	Spool type 008, 009
E	 Operated in position "a".	 Operated in position "b".
F	 Spring offset in position "b".	 Spring offset in position "a".
K	 Operated in position "b".	 Operated in position "a".
M	 Spring offset in position "a".	 Spring offset in position "b".

2 position spools		
Code	Spool position	
B		2 positions. Spring offset in position "b". Operated in position "a".
D		2 positions. Operated in position "a" or "b". No center or offset position.
H		2 positions. Spring offset in position "a". Operated in position "b".

¹⁾ Consider specific spool position.
²⁾ Please order plug separately.
³⁾ Only for voltage 24 V=.

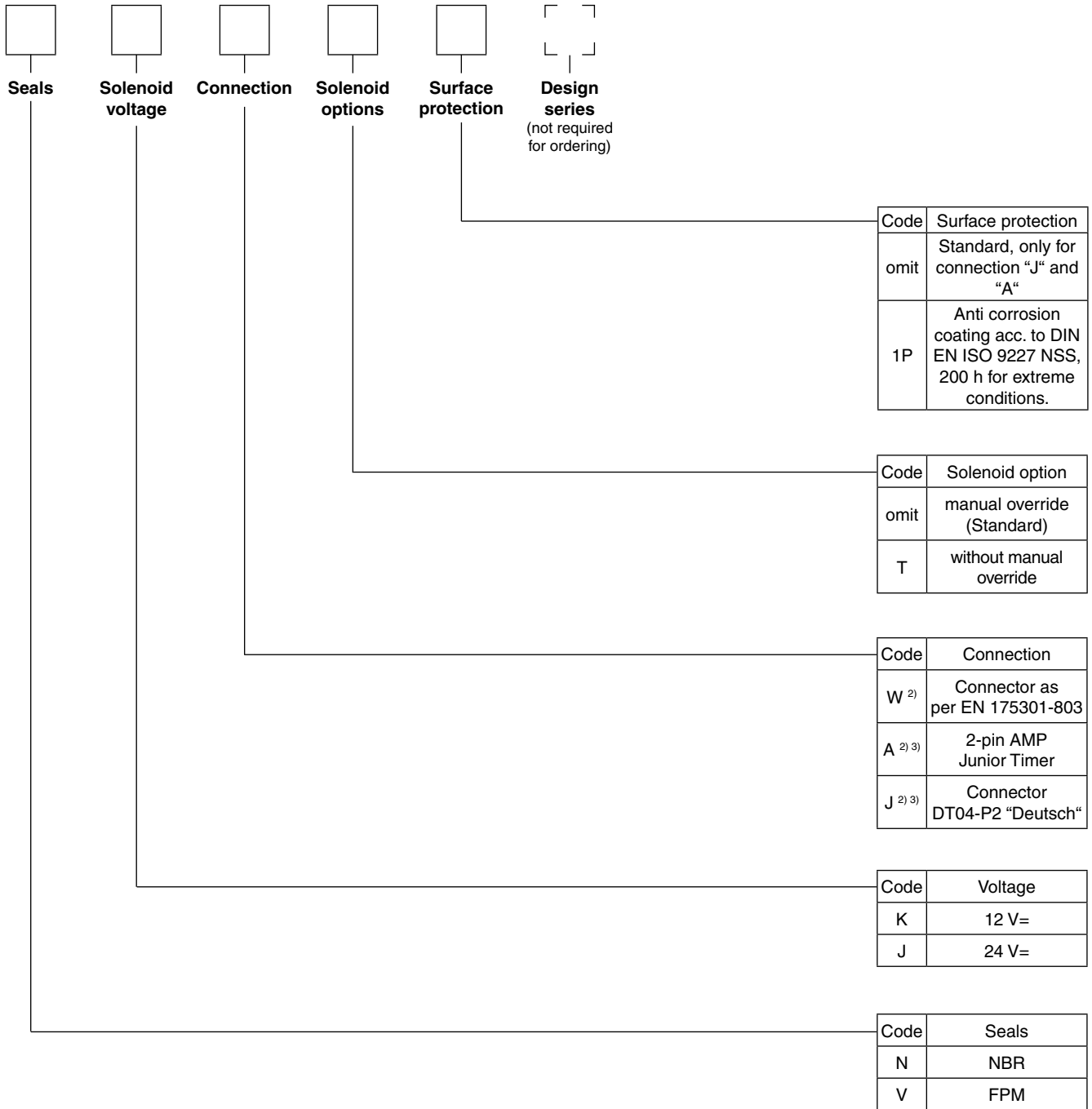

Further spool types on request.

Flow curves

The flow curve diagram shows the flow versus pressure drop operating position and flow direction the relevant curve number is given in the table below.

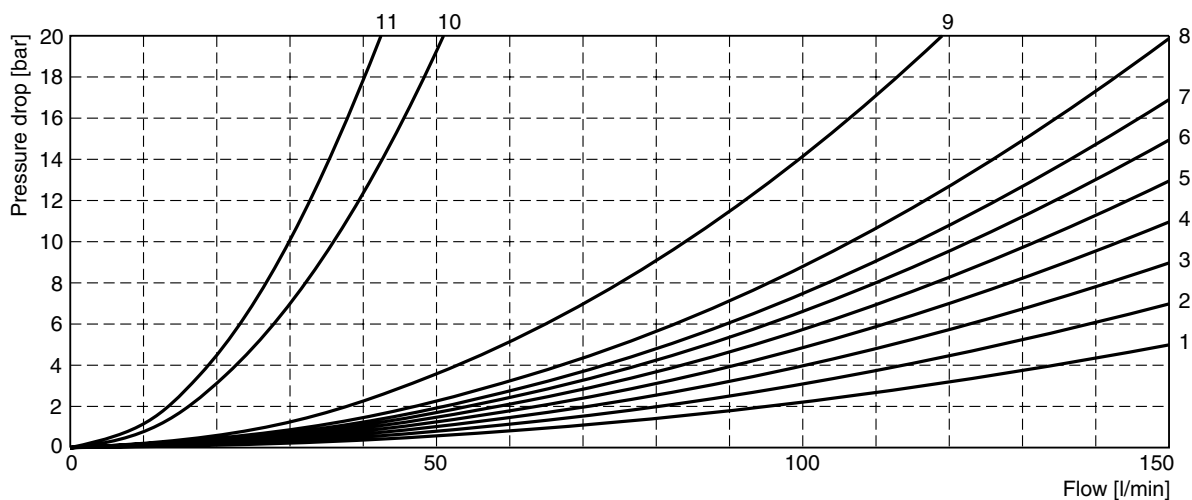

All characteristic curves measured with HLP46 at 50 °C.

Spool	Position b		Position a		Position 0					
	P->A	B->T	P->B	A->T	P->A	P->B	A->T	B->T	P->T	A->B
001	6	5	6	6	-	-	-	-	-	-
002	3	5	3	3	1	1	4	5	1	6
003	2	2	3	1	-	-	3	-	-	-
004	5	4	4	4	-	-	8	8	-	9
005	2	2	2	2	3	-	-	-	-	-
006	1	2	1	3	2	2	-	-	-	3
007	2	1	2	2	-	1	-	2	3	-
010	2	-	2	-	-	-	-	-	-	-
011	2	2	2	2	-	-	11	11	-	11
012	1	2	2	2	10	10	10	10	11	11
014	1	2	2	2	1	-	2	-	3	-
015	2	1	2	2	-	-	-	3	-	-
016	2	2	1	2	-	2	-	-	-	-
020	6	6	5	7	-	-	-	-	-	-
026	5	-	5	-	-	-	-	-	-	-
030	4	5	3	5	-	-	-	-	-	-
	P->B	A->T	P->A	B->T	P->A	P->B	A->T	B->T	P->T	A->B
008	8	7	7	6	-	-	-	-	9	-
009	4	4	5	8	-	-	-	-	9	-
	Position b		Position a							
	P->A	P->B	A->B	P->B	A->T					
021	2	4	8	3	2					
	P->A	B->T		P->A	P->B	A->B				
022	3	2		3	2	8				

Shift limits, DC voltage

The diagrams below specify the shift limits for valves with DC and AC solenoids. Valves with spool position “F” or “M” can only be operated up to 70 % of the limits. The specifications apply to a viscosity of 40 mm²/s and bal-

anced flow conditions. The shift limits can be considerably lower at unbalanced flow conditions. To avoid flow rates beyond the shift limits, a plug-in orifice can be inserted in the P-port.

2

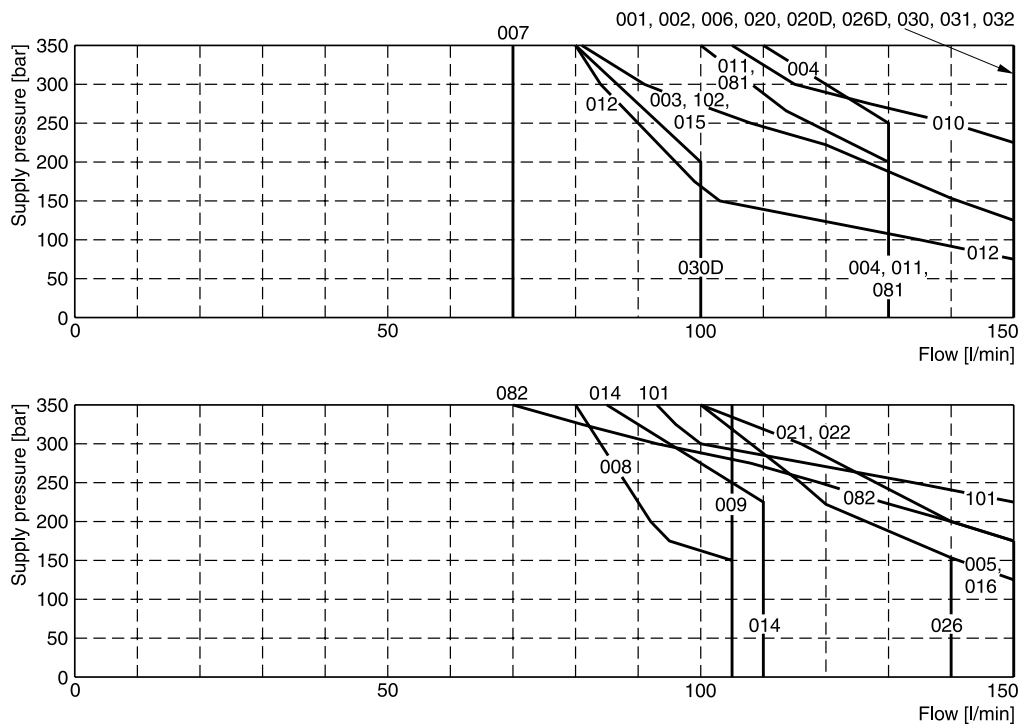

Measured with HLP46 at 50 °C, 90 % U_{nom} and warm solenoids.

**Interface EN 175301-803
 B, E, F -style**

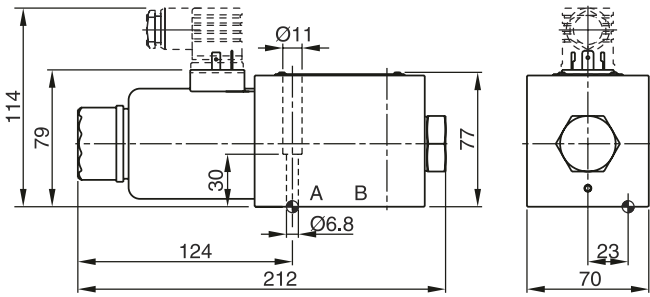

H, K, M -style

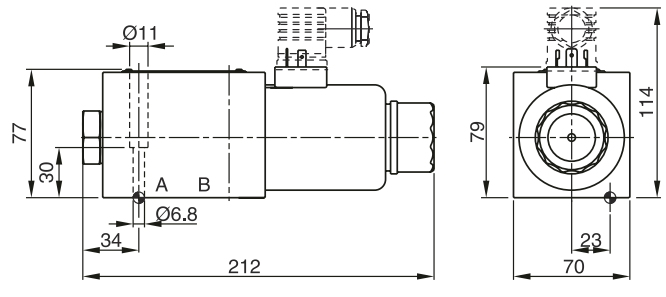

C, D -style

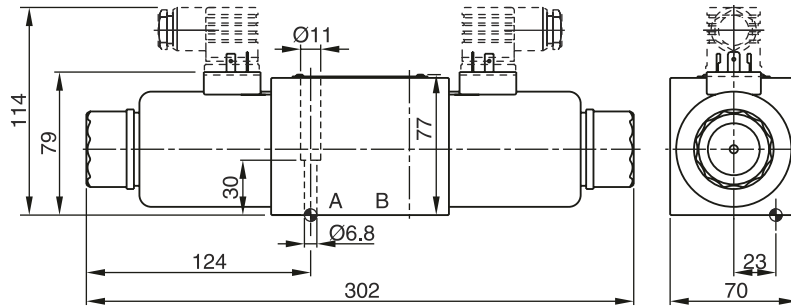



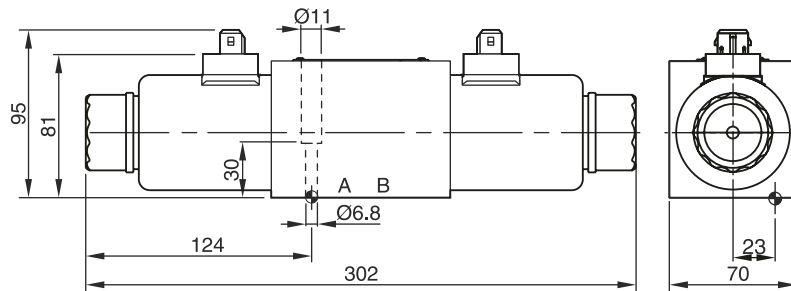

Dimensions with AMP Connector (only C and D -style shown)

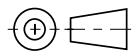
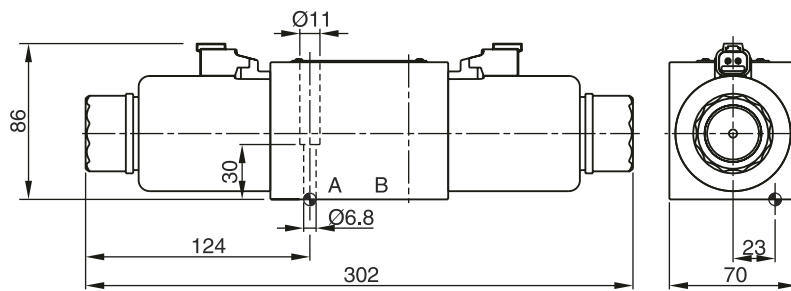

Dimensions with DT04-P2 "Deutsch" Connector (only C and D -style shown)

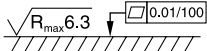

Surface finish	 Kit	 Kit	 Kit	 Kit
	BK385	4x M6x40 ISO 4762-12.9	13.2 Nm ±15 %	NBR: SK-D3W-N-30 FPM: SK-D3W-V-30

The space necessary to remove the plug per EN 175301-803, design type AF is at least 15 mm.
 The torque for the screw M3 of the plug has to be 0.5 to 0.6 Nm.