

Section 9

Lean, Services, Tips, & Tools

Tips	
Pre-Assembly Tips	231
Panel and Wire Mesh Gasket	231
Cutting and Installation	231
Services	
Saw Profile to Length	234
Tap Profile End	234
Step Drill	234
Services	
Surface Locations	235
Chamfer Corner	237
Notch Corner for Extrusion Clearance	237
Notch Corner for Universal Fastener Clearance	237
Tools	
Drilling Jigs	238
Tools	
Drill Bit, Tap, T-Handle	
Wrench	239-240
Spanner Wrenches	241
Lean	
Lean Communication Boards	242-245

Tips

1. Upon receipt of your order, check to see that you have received a complete kit with numbered components. All extrusions are clearly marked with a number designation. Sort all the extrusions according to these designations. If a drawing was supplied, these numbers will correspond with the numbers shown on the drawing.
2. Assembly should be performed on a flat surface as this helps insure proper alignment and perpendicularity of the frame.
3. Thread all end fasteners into tapped ends of extrusions but do not tighten the bolts.
4. Pre-assemble all joiner plates, gussets, brackets, wire mesh clamps and anchor fastener assemblies but do not tighten the bolts.
5. If economy T-nuts are being used on joiner plates, gussets, brackets and any accessories which are to be mounted between end fastenings of the main assembly, then these systems of the T-nut should be installed in the proper T-slot at this time.
6. Install all wheels, leveling feet, hinges, handles and end caps after the main frame is constructed.
7. If solid panels are part of the installation, they should be installed in the T-slot after two sides of its frame have been formed. If panel gasket [12-106] is being used, it should be wrapped around the panel, notched at each corner and then slid into the extrusion's "L-shaped" frame.

Pre-Assembly Instructions and Tips

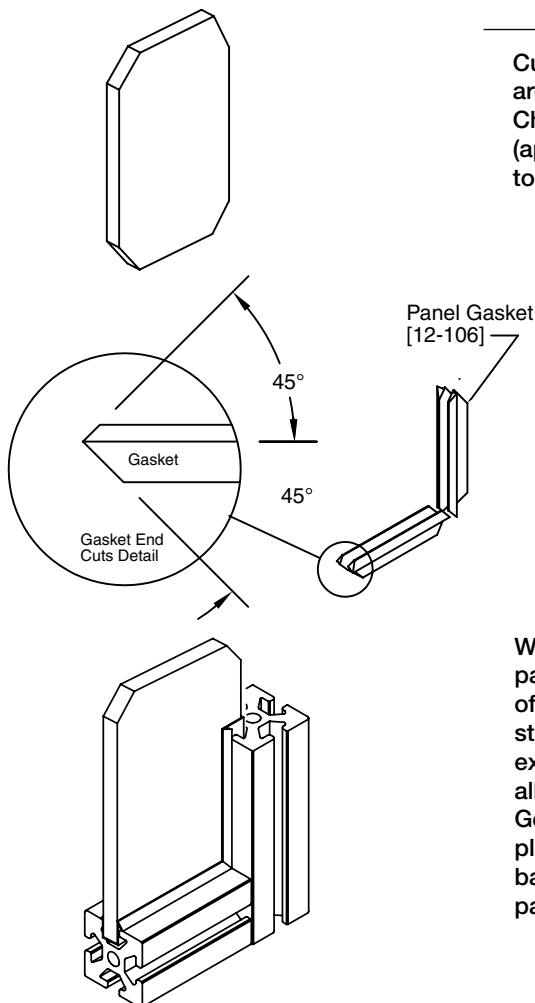

Cut chamfers at panel corners that are adjacent to standard fasteners. Chamfer should be at 45° angle (approx.) and should be cut according to detail on page 235.

Measure the length of each side of the panel and cut the gasket to those lengths. Then cut each end of the gasket as shown above. Two 45° angle cuts will insure proper fit. Then slide the cut gasketing onto the side of the panel.

With the gasketing mounted on the panel, insert the panel into the slot of the extrusion. By loosening the standard fasteners that hold the extrusions together, the panel will be allowed to slide more freely into place. Gently tapping the extrusion into place and tightening the extrusions back together will insure a tight fitting panel.

Panel and Wire Mesh Gasket Cutting and Installation

Description	Part Number
Saw Cuts	
Saw Cut Extrusion up to 40X80/1.5"X3"	19-001
Saw Cut Extrusion up to 80X80/3"X3"	19-002
Saw Cut Extrusion over 80X80/3"X3"	19-003
Saw Cut for Steel Shafts and Roller Track	19-007
Miter Saw Cut Extrusion Different from 45 Degrees	19-104
Miter Saw Cut Extrusion up to 80X80/3"X3" at 45 Degrees	19-105
Miter Saw Cut Extrusion over 80X80/3"X3" at 45 Degrees	19-106
End Taps	
End Tap M5 for 20 Series Profile	19-005
End Tap M5 20mm Deep for Leveling Foot on 20 Series Profile	19-043
End Tap 1/4-20 1" Series Profile	19-008
End Tap 1/4-20 1" Deep for Leveling Foot on 1" Series Profile	19-044
End Tap 5/16-18 for 1.5" or 40 Series Profile	19-009
End Tap 5/16-18 1.25" Deep for Leveling Foot on 1.5" Series Profile	19-045
End Tap M8 for 40 Series Profile	19-010
End Tap M8 35mm Deep for Leveling Foot	19-016
End Drill and Tap M10 45mm Deep for Leveling Foot	19-017
End Tap 3/8-16 1.25" Deep for Leveling Foot on 1.5" Series Profile	19-046
Universal Fastener Machining	
Universal Fastener Machining for 40 Series Profile	19-015
Universal Fastener Machining for 30 and 28 Series Profile	19-034
Universal Fastener Machining for 20 Series Profile	19-035
Universal Fastener Machining for 1.5" Series Profile	19-039
Universal Fastener Machining for 1" Series Profile	19-036
Universal Fastener Machining for Pnuematic Fasteners 20-011 and 20-012	19-020
Machining for Fasteners	
Mill Slot with 7mm Access Hole for 20-132 on Extrusion 12-032	19-024
Machining for Central Connector 20-704 and 20-705	19-037
Machining for Miter Connector 27-022 and 27-024	19-038
Machining for Miter Connector 27-023	19-040

Services

Description	Part Number
Machining for the Side of Extrusion	
Along T-Slot Drill and Counterbore BHCS or SHCS	19-004
Along T-Slot Drill and Countersink for FHCS	19-006
Along T-Slot Drill Thru 7mm Access Hole	19-011
Along T-Slot Drill and Tap M3-M4 or #8-32-#10-32	19-013
Along T-Slot Drill and Tap M5-M10 or 1/4-20-3/8-16	19-012
Along T-Slot Drill and Tap M12 or 1/2-13 and Over	19-014
Along T-Slot Drill 7mm Access Hole Thru 160mm or 11-089	19-025
Drill Thru for Side Mounting Leveling Feet and Casters in Base Plates	19-023
Machining for Parts	
Drill Thru 22.5mm for Quarter Turn Latches	19-018
Drill and Ream for Ball Plunger 23-129	19-022A
Drill and Ream for Ball Plunger 23-128	19-022B
Drill, Tap, and Mill Pocket for Roller 21-069	19-103
Drill Thru for Brake Option on Slide Block	19-140
Panel Machining	
Drill Thru Hole up to 10mm or 3/8"	19-027
Panel or Wire Mesh Corner Notch for Universal Fastener (T-Slot Mounted)	19-028
Panel or Wire Mesh Corner Chamfer for Standard Fastener (T-Slot Mounted)	19-029
Panel Corner Notch Around Extrusion (Flush Mounted)	19-030
Cut Panel or Shear Wire Mesh Each Cut	19-032
Drill Thru and Countersink Hole up to 10mm	19-033
Special Machining	
Special Machining Required for Extrusion	19-210
Special Machining or Cutting Required for Panels or Wire Mesh	19-031

Saw Profile to Length

A cut-to-length extrusion profile can be ordered by specifying the appropriate machining service.
Tolerances: Length = ± 0.04 mm (± 0.015 in)

Maximum Length*: 6000 mm (240 in) for all profiles, except as noted otherwise

Ordering Note:

Saw cut requirements should be described by specifying the machining service number and length of cut required, in millimeters.

Example:

A project requires 4 pieces of the 80x80 profile, saw cut to a length of 1500 mm each. These profiles would be ordered as follows:

Line 1 – Specify the total quantity required:

Part No. = 10-088, Quantity = 4@1500mm

Line 2 – Specify machining services required:

Machining Service No. = 19-002

Quantity = 4

Tap Profile End

This machining service provides one or more tapped holes at the end of an extrusion profile.

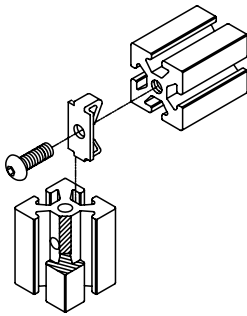

Ordering Note:

Profile end tapping requirements should be described by specifying the machining service number and the end(s) at which the tapped hole is required. See pages 233-234 for locator drawings of the extrusion ends.

Example:

A length of 11-040 profile requires tapping at each end for attachment of the M8 End Fastener Assembly. This machining service would be ordered as follows:

Machining Service No. = 19-010@A, 19-010@B

In this example, there would be charges for two profile end tapping services:

19-010, Quantity = 2

Step Drill

This service provides one or more counterbored holes on the profile T-slot. These holes can accommodate the Universal or Butt Fasteners for both metric or inch extrusions.

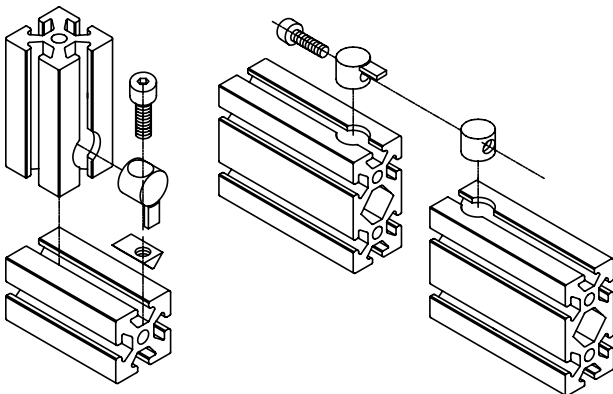

Ordering Note:

Profile step drill requirements should be described by specifying the machining service number and the end(s) at which the drill is required. See pages 233-234 for locator drawings of the extrusion ends.

Example:

Two lengths of 11-080 profile require Butt Fasteners to connect to each other. This machining service would be ordered as follows:

Machining Service No. = 19-015@A3, A6

19-015@B3, B6

In this example, there would be charges for step drill services:

19-015, Quantity = 4

Surface Locations

20 x 20 Profiles
 28 x 28 Profiles
 30 x 30 Profiles
 40 x 40 Profiles
 1" x 1" Profiles
 1.5" x 1.5" Profiles

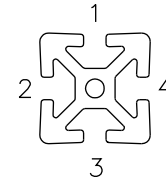
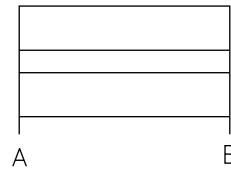
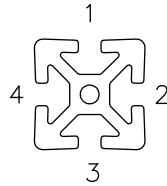

20 x 40 Profiles
 28 x 56 Profiles
 30 x 60 Profiles
 40 x 80 Profiles
 40 x 100 Profiles
 1" x 2" Profiles
 1.5" x 3.0" Profiles

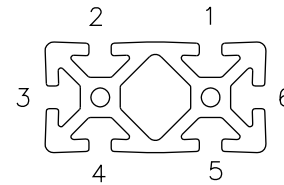
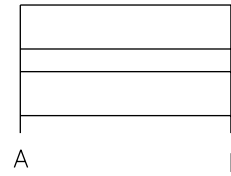
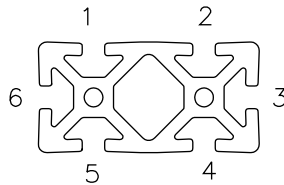

40 x 120 Profiles

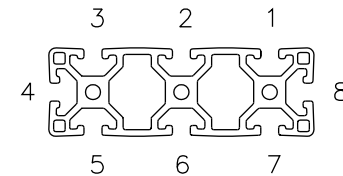
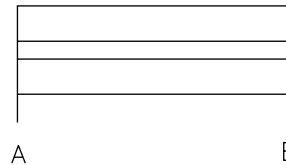
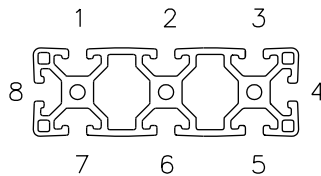

40 x 160 Profiles

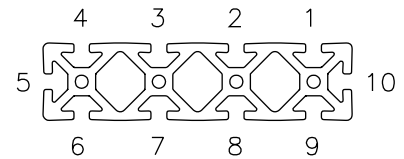
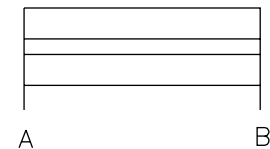
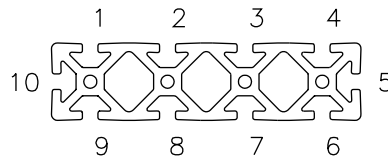

40 x 40 Profiles
 56 x 56 Profiles
 80 x 80 Profiles
 3.0" x 3.0" Profiles

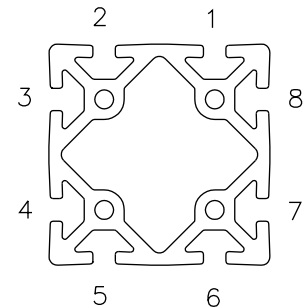
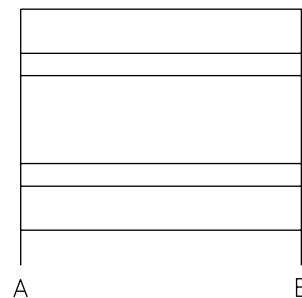
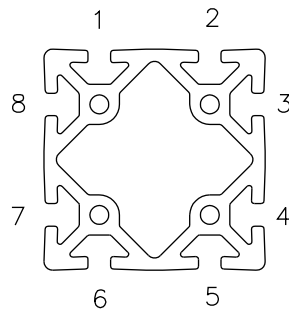

80 x 160 Profiles

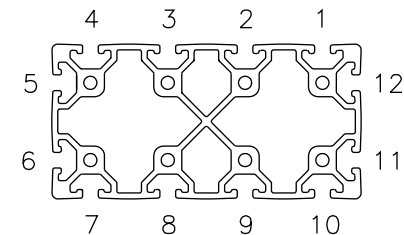
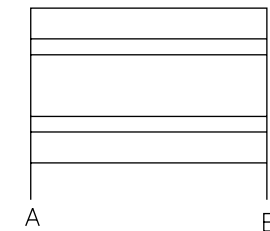
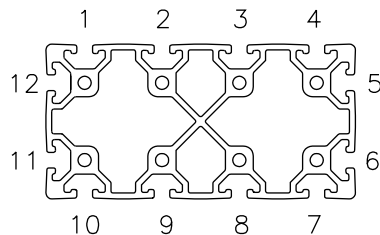

**Lean, Services,
 Tips, & Tools**

Surface Locations

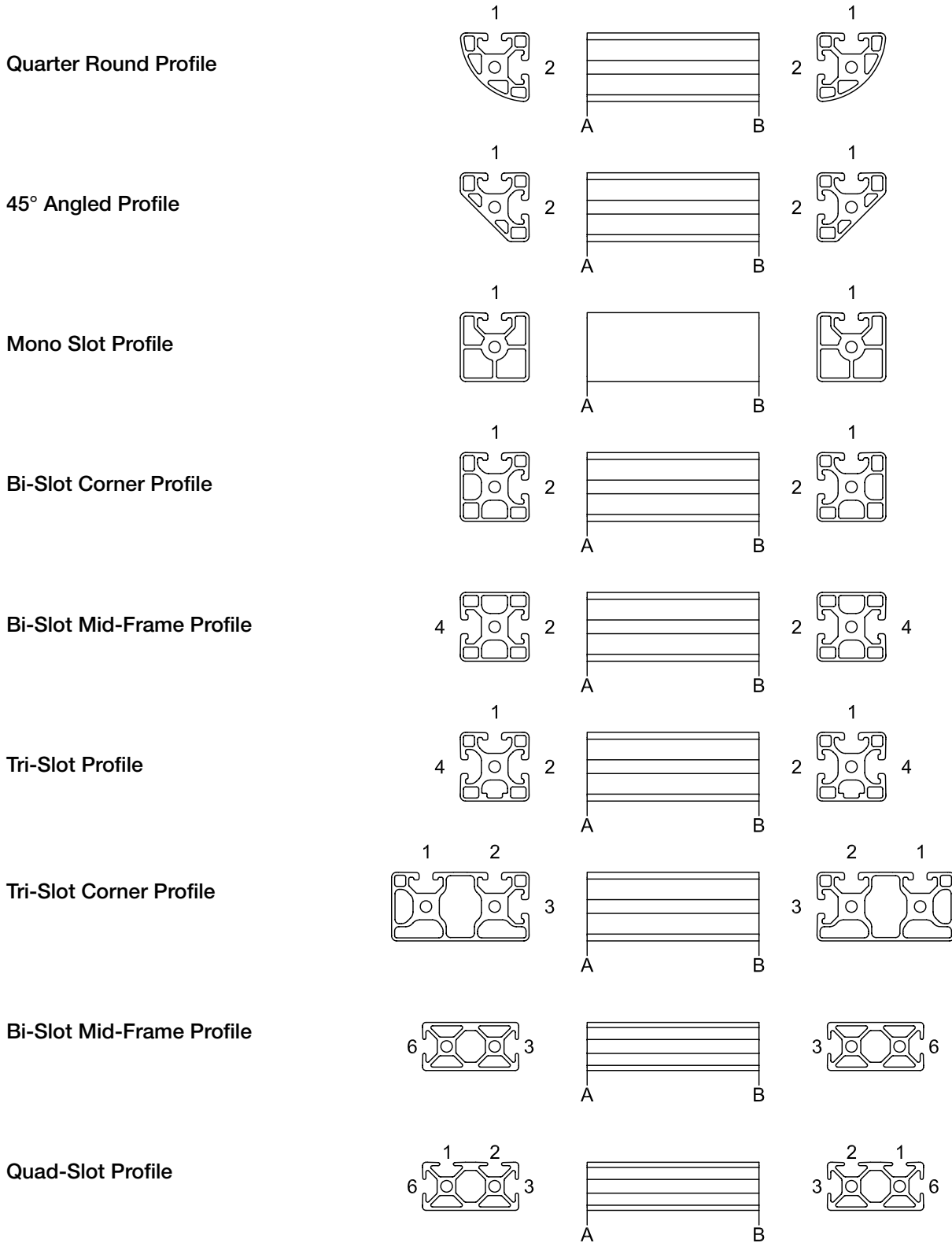

Chamfer Corner for Standard Fastener Clearance

Chamfer gives clearance for standard fastener. This service is needed only when panels or wire mesh are installed in T-slots.

Service 19-029

Dimensions

Profile	A
40	19 (.75")
30	17 (.67")
28	17 (.67")
20	12 (.47")
1.5"	19 (.75")
1"	17 (.67")

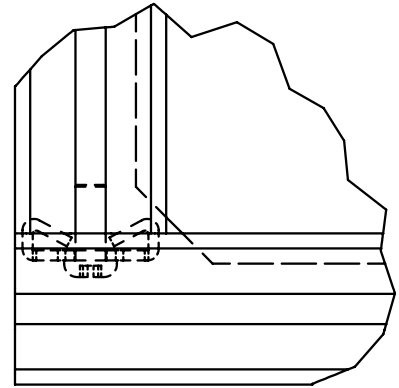
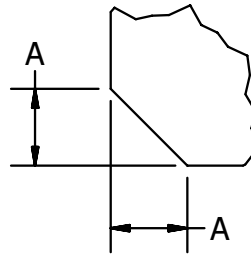

Notch Corner for Extrusion Clearance

Notch gives clearance for perpendicularly mounted extrusions. This service is needed when panels or wire mesh are installed in T-slots or flush mounted.

Service 19-030

Dimensions

Profile	A
40	9 (.35")
30	9 (.35")
28	9 (.35")
20	6.40 (0.250")
1.5"	9 (.35")

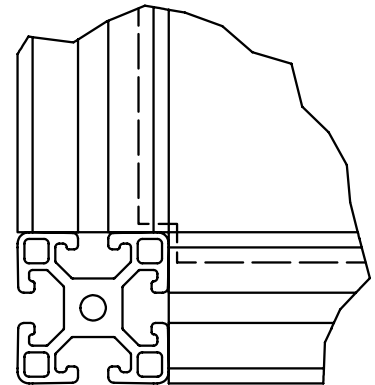
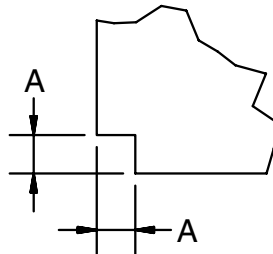

Notch Corner for Universal Fastener Clearance

Notch gives clearance for universal fastener. This service is needed only when panels or wire mesh are installed in T-slots.

Service 19-031

Dimensions

Profile	A	B
40	10 (.39")	41 (1.61")
30	10 (.39")	39 (1.54")
28	9 (.35")	39 (1.54")
20	6.4 (.25")	22.2 (.87")
1.5"	10 (.39")	41 (1.61)
1"	8 (.55")	28 (1.10")

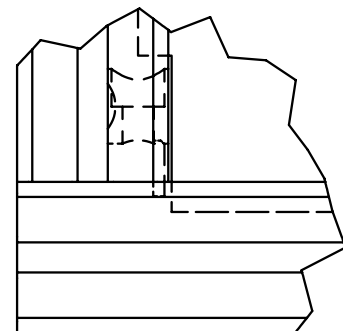
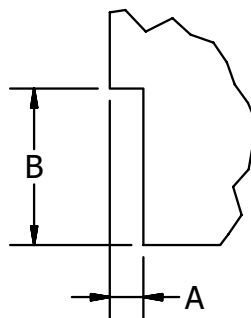

Drilling Jigs Std. Connection

Application

For precise location of 7mm access hole for standard fasteners.

Technical Data

Aluminum, Clear Anodized

Ground and hardened drill bushings with locations 28 and 40mm between access holes. Clamping "T" bolt for firm attachment.

Ordering Information

Description	Unit	Weight (g)	Part #
Drilling Jig 40, Std. Connection	Each	190	40-010
Drilling Jig 80, Std. Connection	Each	360	40-011
Drilling Jig 28, Std. Connection	Each	120	40-027

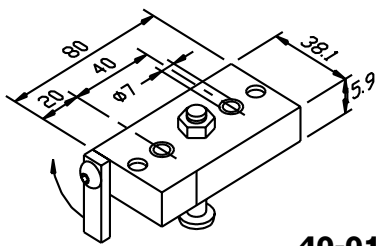

40-010

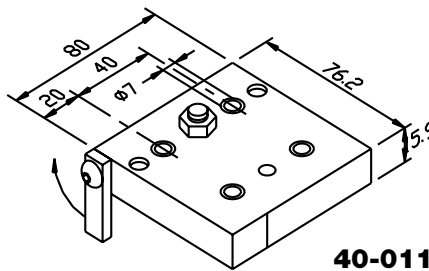

40-011

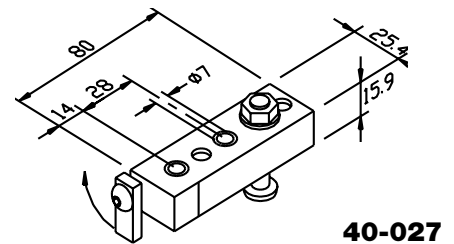

40-027

Step Drill 7x20 Univ. Connection

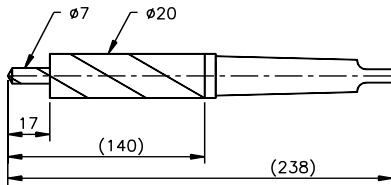

40-023

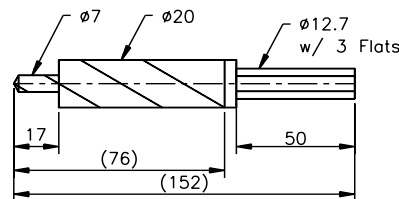

40-024

Application

Used for drilling 20 mm diameter step bore for universal or butt fastener with 40, 30, 28, or 1.5" series profiles.

Technical Data

High Performance, High Speed Steel, nitrated.

#2 Morse Taper or 0.5" diameter with three flats.

Ordering Information

Description	Unit	Weight (g)	Part #
Step Drill 7x20, #2 Morse Taper	Each	260	40-023
Step Drill 7x20 with 3 Flats	Each	190	40-024

Step Drill 9x15

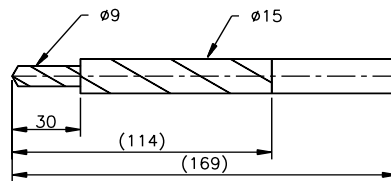

40-025

Application

Used for drilling and counter boring profile for M8 or 5/16-18" BHCS or SHCS.

Technical Data

High Performance, High Speed Steel, Nitrated.

Straight shank.

Ordering Information

Description	Unit	Weight (g)	Part #
Step Drill 9x15	Each	150	40-025

6.8mm Drill Bit

Application

Tap drill size for M8x1.25 and drill size for standard fastener access hole.

Technical Data

High Speed Steel
6.8mm drill, right hand, jobbers length

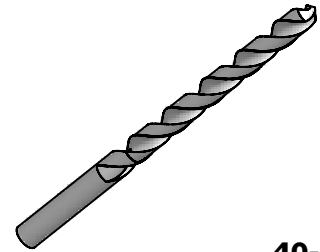

Ordering Information

Description	Unit	Weight (g)	Part #
6.8mm Drill Bit	Each	20	40-018

40-018

Tap

Application

Tooling to provide M8 tap in profile end holes for standard fastening set. Not to be used on light profiles: 10-540, 10-680, 12-1515 & 12-1530.

Technical Data

High Speed Steel
M8x1.25 tap, right hand

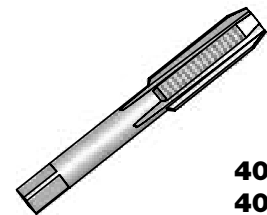

Ordering Information

Description	Unit	Weight (g)	Part #
M8x1.25 Tap	Each	25	40-016
5/16-18 Tap	Each	25	40-516

40-016

40-516

T-Handle Wrench

Application

For tightening of standard and universal connections.

Technical Data

Chrome Vanadium Steel, Nickel Plated
Handle: Acetate

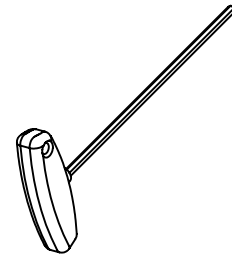

Ordering Information

Description	Unit	Weight (g)	Part #
Hex 5 Wrench with T-Handle	Each	26	40-012
3/16" Wrench with T-Handle	Each	26	40-044
1/4" Wrench with T-Handle	Each	26	40-046

40-012

40-044

40-046

Ball-Headed Wrench

Application

For tightening of standard and universal connections.

Technical Data

Chrome Vanadium Steel, Nickel Plated
Handle: Plastic

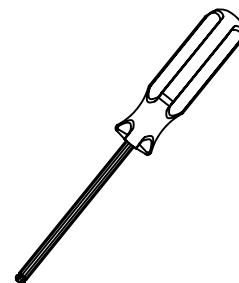

Ordering Information

Description	Unit	Weight (g)	Part #
5mm Wrench with Ball Head	Each	50	40-013
6mm Wrench with Ball Head	Each	50	40-022
3/16" Wrench with Ball Head	Each	50	40-047
1/4" Wrench with Ball Head	Each	50	40-048

40-013

40-022

40-047

40-048

Spanner Wrenches

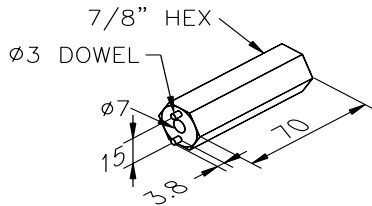

40-029

Application

Designed for tightening spanner nuts on linear guide system 14.

Technical Data

Steel, Black or Brown Finish
 Tempered with Spot Welded Pins
 40-029: Aluminum, Black Anodized
 Steel Pins

Description

Pin Socket Wrench
 Spanner Wrench for Linear 14

Unit	Weight (g)	Part #
Each	80	40-029
Each	40	40-032-14



40-032-14

Modular Lean Solutions

Versatile Display Stands for Lean
Team Tracking and Communication Boards

Communicate. Analyze. Execute.

Visual management and team improvement boards are lean fundamentals and should be deployed across all levels and processes of an organization to maximize customer satisfaction, efficiency, effectiveness and safety.

In a lean workplace environment, visual management and team improvement boards make the status of the current condition obvious at a glance. Utilizing visual information helps us to run our businesses by creating rapid recognition of problems (waste).

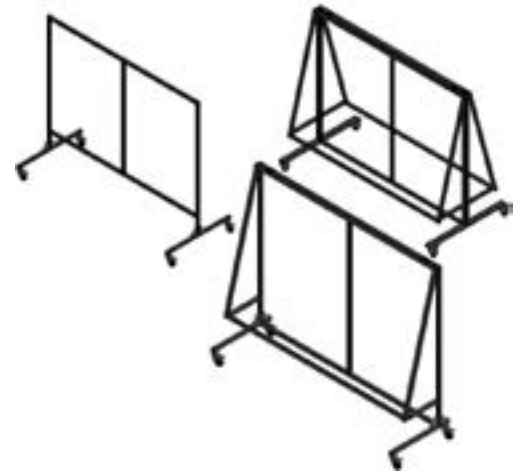

Analysis of displayed data intuitively accelerates and supports the problem-solving. Visual representation of the

PDCA cycle guides teams through effective execution to eliminate *muda* and generate improvements.

Effortless, Mobile, Modular...

Implementing a visual workplace requires a significant time and effort investment to setup and to maintain.

To simplify your lean and quality journey, Parker has created a series of standard, mobile communication board stands using our modular Industrial Profile System (IPS) T-slot aluminum framing system.

These pre-configured designs simplify your implementation by providing a single part number to order your board and mobile stand. Units can be provided either fully assembled or as fully machined kits for easy on-site assembly.

Choose the configuration tailored to the specific needs of your application:

- **Vertical, angled and double angled display styles**
- **Two sizes: 3 x 4 or 4 x 6 feet**
- **Choice of white magnetic dry erase, black push pin, or mount your own board**

With Parker Modular Lean Solutions, there's no need to spend time designing your tracking centers or communication boards. Simply order for quick delivery and start using immediately to uncover problems and drive solutions.

Modular Lean Solutions

Team Tracking and Communication Boards and Stands

With Parker Modular Lean Solutions, there's no need to spend time designing your team tracking and communication boards and stands. Simply order for quick delivery and start using immediately to uncover problems and drive solutions.

Ordering Information

Fill in an order code from each of the numbered fields to create a complete model order code.

1 2 3 4 5

Order Example: 70 - 2 46 - N K

- 1 Display Stand Series**
70 Team Tracking and Communication Boards
- 2 Display Stand Type**
 - 1 Vertical
 - 2 Angled
 - 3 Double Angled
- 3 Display Size**
 - 34 3' x 4'
 - 46 4' x 6'
- 4 Display Stand Type**
 - W White Magnetic
 - P Black Push Pin
 - N No Board
- 5 Package**
 - K Kit
 - A Assembly

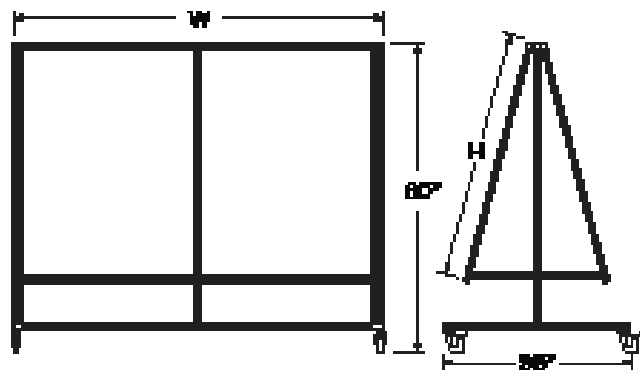
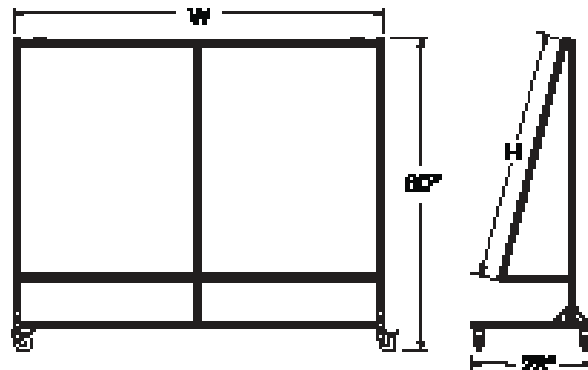
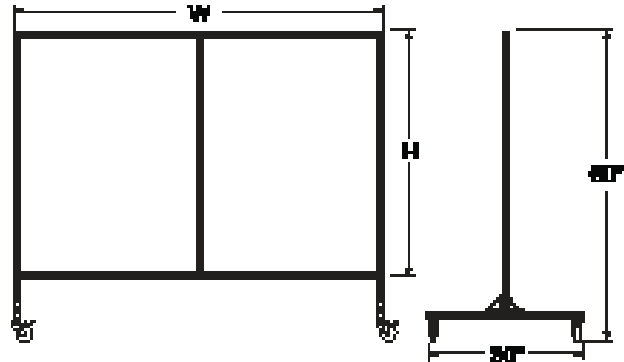

Lean, Services, Tips, & Tools

Modular Lean Solutions

Display Stands for Day by the Hour Tracking

Track. Audit. Execute.

Visual management and day by the hour tracking boards are lean fundamentals and should be deployed across all key processes of an organization to maximize customer satisfaction, efficiency, effectiveness and safety.

Using simple visual devices in the workplace, as simple as the color of a plastic cup, can make all the difference in helping key personnel across an entire shop floor keep track of ongoing operation status, trends and goals.

Track... In a lean workplace environment, visual management and team improvement boards make the tracking of the current condition obvious at a glance. Utilizing visual information helps us to run our businesses by creating rapid recognition of problems (waste).

Audit... Displayed data allows live auditing and enables quick reaction to abnormal situations.

Execute... Day by the hour tracking ensures visual data to support problem-solving activities and the PDCA cycle. Effective execution of the PDCA cycle results in waste elimination and continuous improvement.



Convenient, Standard, Modular...

Implementing a visual workplace requires a significant time and effort investment to setup and to maintain.

To simplify your lean and quality journey, Parker has created a series of standard, day by the hour boards using our modular T-slot aluminum framing system, also known as IPS.

These pre-configured designs simplify your implementation by providing a single part number to order your day by the hour board. Units can be provided either fully assembled or as fully machined kits for easy on-site assembly.

Modular Lean Solutions

Display Stands for Day by the Hour Tracking

Choose the configuration tailored to the specific needs of your application:

- **Floor mount, rolling mobile unit, or wall mount display styles**
- **Available with Andon Post Option for ahead or behind indication or without option**
- **Choice of polycarbonate or black Trespa® backboard**

With Parker Modular Lean Solutions, there's no need to spend time designing your day by the hour boards. Simply order for quick delivery and start using immediately to uncover problems and drive solutions.

Ordering Information

Fill in an order code from each of the numbered fields to create a complete model order code.

1 2 3 4 5 6

Order Example: 71 - 1 1 3 - P K

- Display Stand Series**
71 Day by the Hour Tracking Display Stands
- Board Orientation**
1 Floor Mount
2 Mobile
3 Wall Mount
- Andon Post Option**
1 Andon Post Option (8 total)
2 No Andon Post Option
- Board Size**
3 3' x 3' (approximate)
- Board Type**
P Clear Poly Board for Easel Pad
B Black Trespa Board for Easel Pad
N Ready for Special Board
- Package**
K Kit
A Shipped pre-assembled (except caster sub assemblies, which customer will have to mount to the unit)

Floor Mount

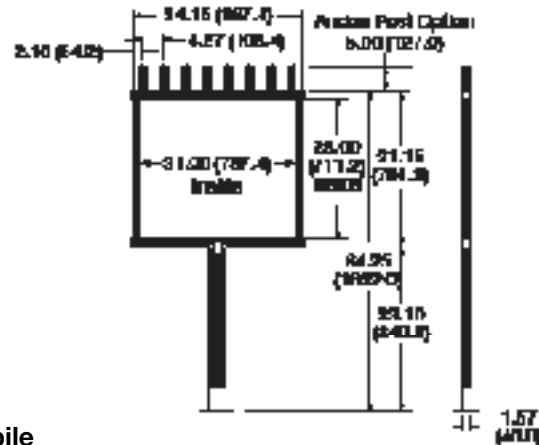

Mobile

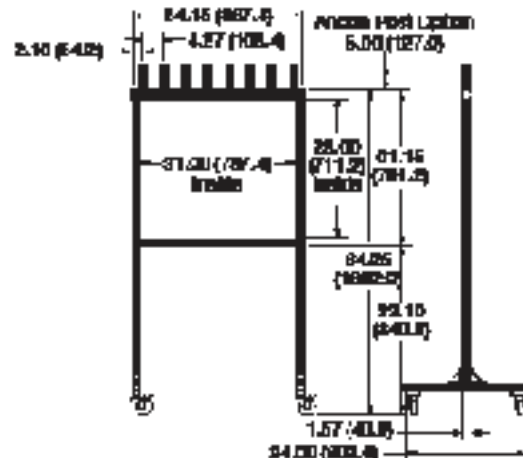

Wall Mount

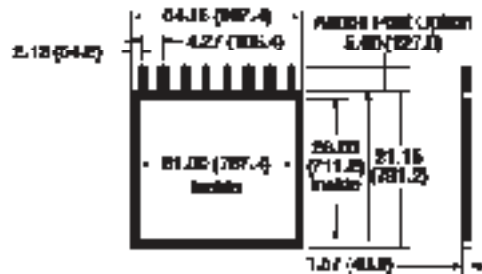

Lean, Services, Tips, & Tools